

INACTIVE
RESCINDED
Rescinded date: 02/03/2018

R-Codes

State Planning Policy 3.1 Residential Design Codes

Prepared under section 26 of the
Planning and Development Act 2005 by the
Western Australian Planning Commission.

2015 R-Codes
(incorporating amendments gazetted on 23/10/15)



Department of
Planning



Western
Australian
Planning
Commission

➤ Contents

Disclaimer

This document has been published by the Department of Planning on behalf of the Western Australian Planning Commission. Any representation, statement, opinion or advice expressed or implied in this publication is made in good faith and on the basis that the government, its employees and agents are not liable for any damage or loss whatsoever which may occur as a result of action taken or not taken, as the case may be, in respect of any representation, statement, opinion or advice referred to herein. Professional advice should be obtained before applying the information contained in this document to particular circumstances.

© State of Western Australia
Published by the
Department of Planning
Gordon Stephenson House
140 William Street
Perth WA 6000

Locked Bag 2506
Perth WA 6001

Published October 2015

website: www.planning.wa.gov.au
email: corporate@planning.wa.gov.au

tel: 08 6551 9000
fax: 08 6551 9001
National Relay Service: 13 36 77
infoline: 1800 626 477

This document is available in alternative formats
on application to Communication Services.

Part 1 – Preliminary

Part 1 – Preliminary	4	Part 5 – Design elements for all single house(s) and grouped dwellings; and multiple dwellings in areas coded less than R40	16	Appendix 1 – Definitions	53
1.1 Citation	4	5.1 Context	16	Tables	
1.2 Purpose of the R-Codes	4	5.2 Streetscape	22	Table 1 – General site requirements for all single house(s) and grouped dwellings; and multiple dwellings in areas coded less than R40.	59
1.3 General objectives of the R-Codes	4	5.3 Site planning and design	25	Table 2a and 2b – Boundary setbacks	60
1.4 Application of the R-Codes	4	5.4 Building design	32	Table 3 – Maximum building heights	61
1.5 Explanatory guidelines	4	5.5 Special purpose dwellings	36	Table 4 – General site requirements for multiple dwellings in areas coded R40 or greater, within mixed use development and/or activity centres	61
Part 2 – R-Codes approval process	5	Part 6 – Design elements for multiple dwellings in areas coded R40 or greater; within mixed use development and activity centres	39	Table 5 – Lot boundary setbacks for sites with an R-Code of R80 and greater or R-AC	62
2.1 R-Codes approval	5	6.1 Context	39	Figures	
2.2 Single house approval	6	6.2 Streetscape	42	Figure Series 1 – Site area measurement	63
2.3 Planning approval for single houses on small lots	6	6.3 Site planning and design	44	Figure 1a – Truncation area may be included	63
2.4 Judging merit of proposals	6	6.4 Building design	48	Figure 1b – Areas of rear laneways or reserves (to a maximum of 2m) are included in minimum site area for single house on battleaxe lot.	63
2.5 Exercise of judgement	6	Part 7 – Local planning framework	52	Figure Series 2 – Street setbacks	64
Part 3 – Accompanying information	8	7.1 Local planning framework consistent with R-Codes	52	Figure 2a – Measuring primary street setbacks	64
3.1 Applications for planning approval	8	7.2 Pre-existing local planning policies	52	Figure 2b – Measuring minor projections into primary street setback	65
3.2 Information requirements	8	7.3 Scope of local planning policies, local development plans, local structure plans and activity centre plans	52	Figure 2c – Measuring street setback for garages and carports	65
3.3 Supporting information requirements	13			Figure 2d – Measuring communal street setbacks	65
Part 4 – Consultation	14				
4.1 Consultation requirement	14				
4.2 Consultation procedure	15				
4.3 Opportunity to respond	15				



Contents

Figure Series 3					
– Wall height for lot boundary setbacks	66	Figure Series 5 – Lot boundary walls	71	Figure Series 10 – Privacy	77
Figure 3a – Cross section, flat site	66	Figure 5a – Elevation – flat site	71	Figure 10a – Establishing the horizontal component of cone of vision	77
Figure 3b – Cross section, sloping site	66	Figure 5b – Elevation – sloped site	71	Figure 10b – Measurement of minimum privacy separation distances	77
Figure 3c – Cross section, flat site	66	Figure 5c – Elevation – sloped site	71	Figure 10c – Measuring privacy setbacks using the cone of vision	78
Figure 3d – Cross section, sloped site	67	Figure Series 6 – Open space	72		
Figure 3e – Cross section, sloped site	67	Figure 6a – Measuring open space	72	Figure Series 11 – Overshadowing	79
Figure 3f – Cross section, alternate levels with existing retaining	67	Figure Series 7 – Building height	73	Figure 11a – Calculation of overshadowing	79
Figure 3g – Cross section, alternate levels with fill	67	Figure 7a – Measuring building height	73	Figure 11b – Proportionate limits from shared northern boundaries	79
Figure 3h – Cross section, skillion roof	67	Figure 7b – Deemed natural ground level	73		
Figure Series 4		Figure Series 8 – Garages and carports	74		
– Wall length for lot boundary setbacks	68	Figure 8a – Carport setbacks	74		
Figure 4a – Articulated walls with major openings (where wall height exceeds 3.5m)	68	Figure 8b – Garage setbacks	74		
Figure 4b – Portions of wall without major openings	68	Figure 8c – Garage doors	75		
Figure 4c – Walls with multiple articulations	68	Figure Series 9 – Sight lines	76		
Figure 4d – Measurement of length of upper floor walls for calculating setbacks	69	Figure 9a – Locations of truncations or reduced fence height	76		
Figure 4e – Boundary setbacks for walls greater than Table 2a and 2b	69				
Figure 4f – Reduced boundary setbacks	70				



[Return to contents page](#)

Part 1 – Preliminary

- 1.1 Citation
- 1.2 Purpose of the R-Codes
- 1.3 General objectives of the R-Codes
- 1.4 Application of the R-Codes
- 1.5 Explanatory guidelines

Part 1 – Preliminary

1.1 Citation

This state planning policy is made under section 26 of the *Planning and Development Act 2005*. This policy is cited as State Planning Policy 3.1 Residential Design Codes or R-Codes.

1.2 Purpose of the R-Codes

The purpose of the R-Codes is to provide a comprehensive basis for the control of **residential development** throughout Western Australia.

1.3 General objectives of the R-Codes

The R-Codes have the following objectives.

1.3.1 Objectives for residential development

- To provide **residential development** of an appropriate design for the intended residential purpose, density, context of place and **scheme** objectives.
- To encourage design consideration of the social, environmental and economic opportunities possible from new housing and an appropriate response to local amenity and place.
- To encourage design which considers and respects heritage and local culture.
- To facilitate residential development which offers future residents the opportunities for better living choices and affordability.

1.3.2 Objectives for the planning governance and development process

- To encourage design which is responsive to **site**, size and geometry of the **development site**.
- To allow variety and diversity as appropriate where it can be demonstrated this better reflects context or **scheme** objectives.
- To ensure clear scope for scheme objectives to influence the assessment of proposals.
- To ensure certainty in timely assessment and determination of proposals applied consistently across State and local government.

1.3.3 Application of objectives

In assessing and determining proposals for residential (including residential component of **mixed use development** and **activity centres**), the **decision-maker** shall have regard to the above general objectives, and any objectives provided in the R-Codes and the **scheme**.

1.4 Application of the R-Codes

The R-Codes apply throughout Western Australia.

Parts 1 to 4 and 7 of the R-Codes apply to all **residential development** (including residential components of **mixed use development** and **activity centres**).

Part 5 and associated tables and figures apply to:

- all **single houses**;
- all **grouped dwellings**; and
- multiple dwellings** in areas with a coding of less than R40.

Part 6 and associated tables and figures apply to:

- multiple dwellings in areas with a coding of R40 or greater; and
- mixed use development** and **activity centres**.

Part 7 applies to the **local planning framework**.

Throughout this document, words written in **bold** print have a corresponding definition listed in Appendix 1.

1.5 Explanatory guidelines

The Western Australian Planning Commission (**WAPC**) may prepare more detailed explanatory guidelines on the matters addressed in the R-Codes, in consultation with local government and relevant stakeholders, to meet the objectives of the R-Codes and, if prepared, these should be taken into account in the determination of proposals.

The guidelines, which may be amended from time to time provide advice and guidance to assist interpretation and assessment of proposals against the **design principles** and/or **deemed-to-comply** provisions of the R-Codes.



Part 2 – R-Codes approval process

[Return to contents page](#)

Part 2 – R-Codes approval process

- 2.1 R-Codes approval
- 2.2 Single house approval
- 2.3 Planning approval for single houses on small lots
- 2.4 Judging merit of proposals
- 2.5 Exercise of judgement

2.1 R-Codes approval

2.1.1

The R-Codes approval process is illustrated in the process flowchart below. This process flowchart has been designed as a guide for all **decision-makers**, developers and proponents using the R-Codes.

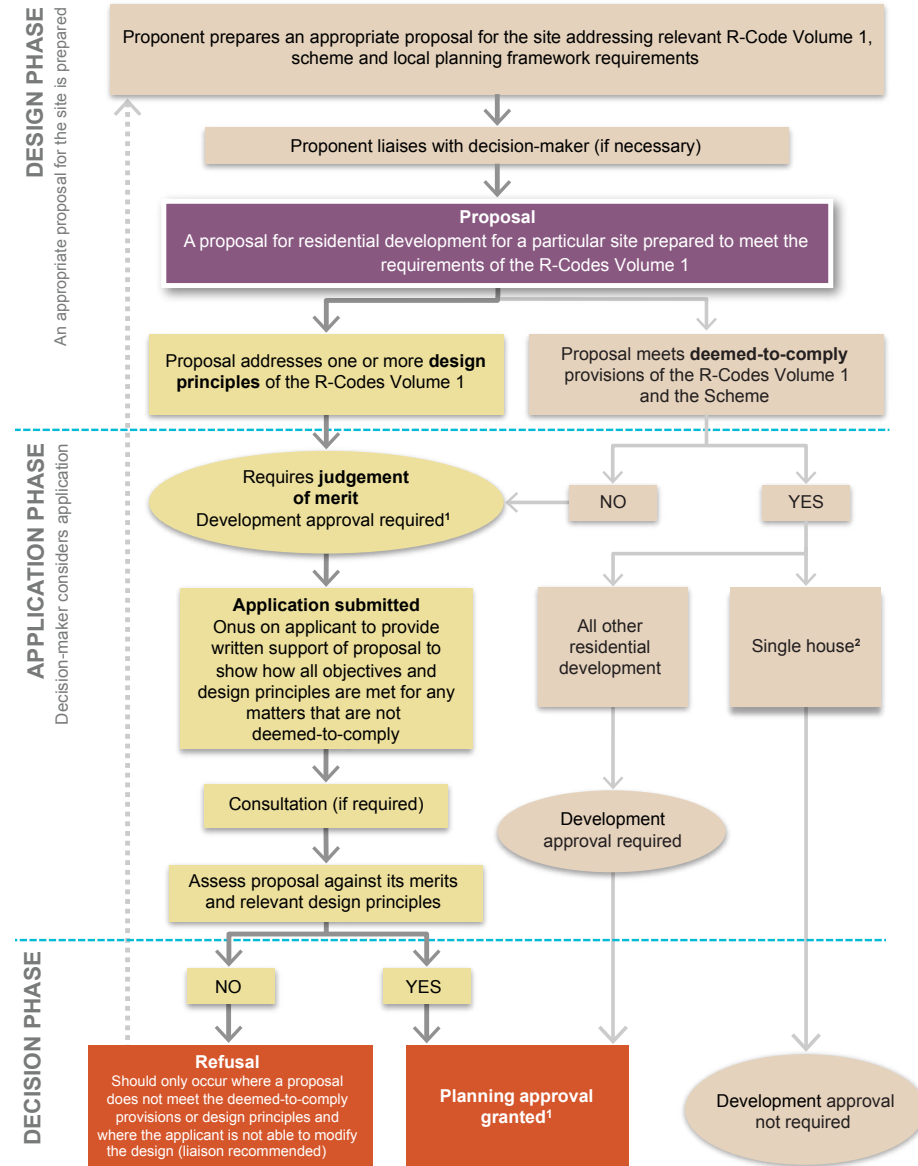

Notes

1. A decision-maker may use an alternative mechanism to planning approval to undertake assessment of proposals for **single house** as per clause 2.2.2.
2. The R-Codes do not require planning approval for a **single house** on a lot greater than 260m² or a lot subject to an approved **local development plan** or **local structure plan**; although, a **scheme** may require planning approval for a single house irrespective of the requirements of the R-Codes as per clause 2.3.
3. This flowchart does not illustrate the determination review process possible via the State Administrative Tribunal.



Part 2 – R-Codes approval process

[Return to contents page](#)

Part 2 – R-Codes approval process

- 2.1 R-Codes approval
- 2.2 Single house approval
- 2.3 Planning approval for single houses on small lots
- 2.4 Judging merit of proposals
- 2.5 Exercise of judgement

2.1.2

Where planning approval is required under a **scheme** a planning application shall be lodged with the relevant **decision-maker** for assessment and making a determination.

2.1.3

All applications for planning approval must provide all necessary details required under the **scheme** for the **decision-maker** to assess the proposal, including details where the application complies and does not comply with R-Code requirements.

2.1.4

All **residential development** is to comply with the requirements of the R-Codes. Approval under and in accordance with the R-Codes is required if the proposed residential development:

- (a) does not satisfy the **deemed-to-comply** provisions of Parts 5 and/or 6 of the R-Codes as appropriate; or
- (b) proposes to address a **design principle** of Parts 5 and/or 6 of the R-Codes which therefore requires the exercise of judgement by the **decision-maker**.

2.2 Single house approval

2.2.1

A proposal for a **single house** that meets the **deemed-to-comply** provisions of the R-Codes does not require planning approval, unless otherwise required by the **scheme** or clause 2.3.

2.2.2

Where a proposal for a **single house**:

- (a) does not satisfy the **deemed-to-comply** provisions; and
- (b) proposes to address a **design principle** of Part 5 of the R-Codes;

an application for planning approval (or other application as determined by the **decision-maker**) shall be made and determined prior to the issuing of a building permit.

2.3 Planning approval for single houses on small lots

Planning approval is required for the erection of a single house on any **lot** smaller than 260m², except where the single house complies with a **local structure plan** or **local development plan**.

2.4 Judging merit of proposals

Where a proposal does not meet **deemed-to-comply** provision(s) of the R-Codes and addresses **design principle(s)**, the **decision-maker** is required to exercise judgement to determine the proposal.

Judgement of merit is exercised only for specific element(s) of a proposal which do not satisfy the relevant deemed-to-comply provision(s).

2.5 Exercise of judgement

2.5.1

Subject to clauses 2.5.2 and 2.5.3, the **decision-maker** is to exercise its judgement to consider the merits of proposals having regard to objectives and balancing these with the consideration of **design principles** provided in the R-Codes.

The decision-maker, in its assessment of a proposal that addresses the design principle(s), should not apply the corresponding **deemed-to-comply** provision(s).



Part 2 – R-Codes approval process

[Return to contents page](#)

Part 2 – R-Codes approval process

- 2.1 R-Codes approval
- 2.2 Single house approval
- 2.3 Planning approval for single houses on small lots
- 2.4 Judging merit of proposals
- 2.5 Exercise of judgement

2.5.2

In making a determination on the suitability of a proposal, the **decision-maker** shall exercise its judgement, having regard to the following:

- (a) any relevant purpose, objectives and provisions of the **scheme**;
- (b) any relevant objectives and provisions of the R-Codes;
- (c) a provision of a **local planning policy** adopted by the decision-maker consistent with and pursuant to the R-Codes; and
- (d) orderly and proper planning.

2.5.3

The **decision-maker** shall not vary the minimum or average **site area** per **dwelling** requirements set out in **Table 1** (except as provided in the R-Codes or the **scheme**).

2.5.4

The **decision-maker** shall not refuse to grant approval to an application where the application satisfies the **deemed-to-comply** provisions of the R-Codes and the relevant provisions of the **scheme** and any relevant **local planning policy**.

2.5.5

For the purpose of the R-Codes, a **local structure plan, local development plan or local planning policy**, will only be a relevant consideration in the exercise of judgement where it is:

- (a) specifically sanctioned by a provision of the R-Codes;
- (b) consistent with the **design principles** of the R-Codes; and
- (c) consistent with the objectives of the R-Codes.



Part 3 – Accompanying information

[Return to contents page](#)

Part 3 – Accompanying information

- [3.1 Applications for planning approval](#)
- [3.2 Information requirements](#)
- [3.3 Supporting information requirements](#)

3.1 Applications for planning approval

Where:

- (a) planning approval is required under the **scheme**;
- (b) the proposed development requires the **decision-maker** to exercise its judgement in respect to the R-Codes; or
- (c) planning approval is required by clause 2.3;

an application shall be made to the decision-maker on the appropriate form(s).

3.2 Information requirements

3.2.1

Unless otherwise determined by the **decision-maker**, applications for **residential development** shall be supported with information about the **development site**, the proposed development, and **adjoining properties** contained in an existing **site** analysis plan, a proposed **development site** plan and drawings in accordance with the application information matrix below.

3.2.2

The application information matrix indicates which information for certain types of applications:

- (a) shall be provided to support the application as denoted by “I” in the matrix;
- (b) may be required to be provided, at the discretion of the **decision-maker**, dependent on the nature of an application, as denoted “O” in the matrix; or
- (c) may be required for an application which proposes to apply one or more **design principle(s)**, as denoted “*” in the matrix.

Notwithstanding the information requirements set out in clause 3.2, additional supporting information may be required under certain circumstances as outlined in clause 3.3.

3.2.3

An existing **site** analysis plan(s) shall be provided at a scale of not less than 1:200 containing the information outlined in the application information matrix relevant to the application type.

3.2.4

A proposed **development site** plan(s) (which may be combined with the **site** analysis plan at the discretion of the **decision-maker** as set out in clause 3.2.3) shall be provided at a scale of not less than 1:200 containing the information requirements, as outlined in the application information matrix relevant to the application type.

3.2.5

A proposed **development** drawings plan(s) shall be provided as a scale of not less than 1:100 containing the information requirements, as set out in the application information matrix relevant to the application type.



Part 3 – Accompanying information

[Return to contents page](#)

Part 3 – Accompanying information

- 3.1 Applications for planning approval
- 3.2 Information requirements
- 3.3 Supporting information requirements

Application information matrix

Application information		Application type							
		Single house	Grouped dwelling	Multiple dwellings (land coded less than R30)	Multiple dwelling (land coded R30 and above)/mixed use development and activity centres	Aged and dependent persons' dwellings	Single bedroom dwellings	Ancillary dwellings	Outbuildings
<p>"I" shall be provided to support the application</p> <p>"O" may be required to be provided, at the discretion of the decision-maker, dependent on the nature of an application</p> <p>"*" may be required for an application which proposes to apply one or more design principle(s)</p>									
1. Site analysis plan showing the following:									
a	street name, lot number and address								
b	north point and scale bar								
c	all site boundaries and area dimensions and street frontages								
d	existing levels to an established datum, preferably using Australian Height Datum (AHD), contours at maximum intervals of 0.5m and spot levels at all boundaries at intervals no greater than 5m								
e	the position and dimensions, setback distances both horizontal and vertical, of existing buildings , retaining walls and other structures								
f	the position, type, and size of any existing tree exceeding 3m and/or significant landscaping features								
g	the street verge, including footpaths, street trees, crossovers, truncations, power poles and any services such as telephone, gas, water and sewerage in the verge								O
h	the location of all service connections								
i	the location of any easement or piped service traversing the site and any sewer or sewer connection point servicing the site								
j	the location of any access restrictions such as road islands adjacent to the site								
k	the position of any adjoining and existing buildings that might affect, or be affected by, the proposed development , including the position of the proposed development, levels and position of habitable room windows, and designated locations of outdoor living areas								



Part 3 – Accompanying information

[Return to contents page](#)

Part 3 – Accompanying information

- 3.1 Applications for planning approval
- 3.2 Information requirements
- 3.3 Supporting information requirements

Application information		Application type							
		Single house	Grouped dwelling	Multiple dwellings (land coded less than R30)	Multiple dwelling (land coded R30 and above)/mixed use development and activity centres	Aged and dependent persons' dwellings	Single bedroom dwellings	Ancillary dwellings	Outbuildings
l	exposure of the site to prevailing winds	○	○			○	○	○	
m	any impacted view-lines of significance related to the streetscape and to and from public places		○	○		○	○		
n	streetscape elevations (i.e. photographs and/or drawings of adjoining development) showing any existing buildings on-site and on the adjoining sites , showing height, roof and wall materials, windows and roof pitch		○	○		○	○	○	
o	a cadastral base identifying all lots located within the street block on which the site is located as well as the lots on the opposite side of the street and location, height, street setback and land use of all buildings located on these lots		○	○		○	○	○	
p	any listed heritage places and landmarks within close proximity to the development	○	○	○		○	○	○	
q	location of retail and community services and public open spaces within 800m walkable catchment					○	○		
r	location of train station on high frequency rail routes (800m walkable catchment) and bus stops on high frequency bus routes (250m walkable catchment)								
s	any sources of nuisance emissions such as noise, light, and odour that may have a bearing on the residential proposal								



Part 3 – Accompanying information

[Return to contents page](#)

Part 3 – Accompanying information

- 3.1 Applications for planning approval
- 3.2 Information requirements
- 3.3 Supporting information requirements

Application information		Application type							
		Single house	Grouped dwelling	Multiple dwellings (land coded less than R30)	Multiple dwelling (land coded R30 and above)/mixed use development and activity centres	Aged and dependent persons' dwellings	Single bedroom dwellings	Ancillary dwellings	Outbuildings
<p>"I" shall be provided to support the application</p> <p>"O" may be required to be provided, at the discretion of the decision-maker, dependent on the nature of an application</p> <p>"*" may be required for an application which proposes to apply one or more design principle(s)</p>									
2. Proposed development site plan showing the following									
a	property details, north point and scale bar, and existing contours and levels as set out in provision 1(a)-(d)								
b	the horizontal position, floor levels and positions of all openings of any existing and proposed building or part of a building on the subject property where any such building is within 7.5m of a lot boundary								
c	the position and levels of all proposed buildings, walls , fences, retaining walls and other structures								
d	the position of paved vehicle, pedestrian access ways and on-site and off-site car parking spaces								
e	the existing structures and trees (indicate which are to be retained and which are to be removed)								
f	private open space areas and dimensions including areas to be landscaped						O		O
g	proposed finished site levels								O
h	shadow that would be cast at noon on 21 June by any proposed building onto any adjoining property								O
i	site area boundaries of any proposed strata lots								
j	position and dimensions of any balcony or major openings to any active habitable space in any wall of an adjoining building which is visible from the development site and is located within 6m of a boundary of the development site	*	*	*	*	*	*	*	*
k	position and level of any accessible area (e.g. lawn, paving, decking, balcony or swimming pool) on any adjoining property and within 7.5m of the boundaries of the development site	*	*	*	*	*	*	*	*



Part 3 – Accompanying information

[Return to contents page](#)

Part 3 – Accompanying information

- 3.1 Applications for planning approval
- 3.2 Information requirements
- 3.3 Supporting information requirements

Application information		Application type							
		Single house	Grouped dwelling	Multiple dwellings (land coded less than R30)	Multiple dwelling (land coded R30 and above)/mixed use development and activity centres	Aged and dependent persons' dwellings	Single bedroom dwellings	Ancillary dwellings	Outbuildings
	<p>"I" shall be provided to support the application</p> <p>"O" may be required to be provided, at the discretion of the decision-maker, dependent on the nature of an application</p> <p>"*" may be required for an application which proposes to apply one or more design principle(s)</p>								
I	additional or marked-up plans and sections showing the cone of vision and critical lines of sight from those major openings as they relate to the adjoining property	*	*	*	*	*	*	*	
m	details of screening or other measures proposed to be used to reduce overlooking	*	*	*	*	*	*	*	
n	plans and sections of sufficient information to explain how the adjoining property as a whole would be affected by overshadowing	*	*	*	*	*	*	*	
o	landscape development plan addressing matters set out in clauses 5.3.2 or 6.3.2		I	I	I	O	O	O	
3. Development drawings showing the following:									
a	all floor plans and their distances from the boundaries of the site	I	I	I	I	I	I	I	I
b	all elevations, with the existing and natural ground levels, wall heights and roof heights related to an established datum, preferably using Australian Height Datum (AHD), contours at maximum intervals of 0.5m	I	I	I	I	I	I	I	I
c	cross-sections through any proposed areas of excavation or filling with the relevant existing, natural and proposed levels related to an established datum, preferably using Australian Height Datum (AHD), contours at maximum intervals of 0.5m	I	I	I	I	I	I	I	I
d	proposed materials, colours and finishes of the exterior of the building	I	I	I	I	I	I	I	I
e	sufficient plans and accompanying information to demonstrate compliance with the relevant provisions of AS4299 (Adaptable housing)	O	O	O	O	I	O		



Part 3 – Accompanying information

[Return to contents page](#)

Part 3 – Accompanying information

- 3.1 Applications for planning approval
- 3.2 Information requirements
- 3.3 Supporting information requirements

3.3 Supporting information requirements

The following additional supporting information shall be provided under certain planning circumstances to enable proper assessment by the **decision-maker**.

3.3.1

Where a component of the proposal proposes to apply one or more **design principle(s)**, it is necessary to assess that component of the design against the relevant design principle(s). Additional supporting information shall include:

- (a) identification of all design elements that are not **deemed-to-comply**; and
- (b) written justification as to how the application/proposal meets the design principles and objectives of the R-Codes and any relevant **scheme** and **local planning policy** objectives and requirements.

3.3.2

Where an existing **heritage place** or **site** is listed on any Commonwealth, State or local heritage register, municipal heritage inventory or is otherwise listed under the **scheme**, and is proposed to be demolished, or its external appearance significantly altered, the following additional information is required to be submitted:

- (a) a copy of any heritage assessment or report or conservation plan that has previously been carried out for the place;
- (b) photographs of the place or parts of the place proposed to be affected; and
- (c) an explanation for the proposal as it relates to the heritage value of the site.

3.3.3

Any additional supporting information required under the **local planning framework**.



[Return to contents page](#)

Part 4 – Consultation

4.1 Consultation requirement

4.2 Consultation procedure

4.3 Opportunity to respond

Part 4 – Consultation

4.1 Consultation requirement

4.1.1

Where a **development** proposal is **deemed-to-comply**, it will not require advertising to adjoining owners and occupiers.

4.1.2

Where an application is made for planning approval, or other approval process as used by the **decision-maker**, which presents:

- (a) a proposal against one or more **design principles** of the R-Codes; and
- (b) a possible impact on the amenity of adjoining owners and occupiers;

then there may be grounds for the decision-maker to advertise the proposal to these owners and occupiers.

4.1.3

Where the **decision-maker** is to judge the merits of a proposal and:

- (a) the merits of the proposal are a matter of technical opinion; and
- (b) the decision-maker is satisfied it will not adversely impact the adjoining residential property or the **street**,

it is not necessary to seek comment from adjoining owners and occupiers about the proposal, except where specifically required by the **scheme** or relevant **local planning policy**.

4.1.4

The provisions of clauses 4.2 and 4.3 apply to provide for adjoining owners and occupiers, who in the opinion of the **decision-maker** are likely to be affected, to view and comment on the proposal.

4.1.5

Where a matter is advertised for comment the notification should direct adjoining owners and occupiers to focus their comments to the particular **design principle(s)** that the proposal is addressing.

4.1.6

The **decision-maker**, upon receipt of any comment(s) from adjoining owners and occupiers, is required to consider and balance comment(s) with its technical opinion when it exercises its judgement to determine the proposal.



Part 4 – Consultation

[Return to contents page](#)

Part 4 – Consultation

- [4.1 Consultation requirement](#)
- [4.2 Consultation procedure](#)
- [4.3 Opportunity to respond](#)

4.2 Consultation procedure

4.2.1

In the circumstances prescribed in clause 4.1, any owner and occupier of **adjoining properties**, as identified by the **decision-maker**, shall be notified of the:

- (a) **site** and general nature of the proposal(s);
- (b) nature of the proposal involved;
- (c) availability to view details of the proposals; and
- (d) due date by which any comments are to be lodged with the decision-maker, being at least fourteen (14) days after date of posting of notification, or as specified within the **scheme**, and invited to comment on that part of the proposed **development** that does not meet the **deemed-to-comply** provisions of the R-Codes.

4.2.2

Where no response is received within the time specified from the date of notification, the **decision-maker** may determine the proposal on its merits and issue its decision.

4.2.3

Where a notification has been satisfactorily carried out (in the opinion of the **decision-maker**) by the proponent, and comments are provided which accompany the proposal, the decision-maker may consider and determine the proposal without further notification.

The decision-maker shall be satisfied the information provided and comments tendered are accurate and verified subject to the notification of the information in clause 4.2.1 and proof of posting by registered post provided to the decision-maker.

4.2.4

Where the **decision-maker** considers a proposal to be unacceptable it may determine to refuse the proposal without undertaking neighbour consultation.

4.3 Opportunity to respond

4.3.1

A summary of all comments received in response to an invitation under clause 4.2 shall be provided to the proponent on request and, if so requested, a period of not more than 10 days should be allowed within which the proponent may submit a response to the comments prior to the **decision-maker** considering the proposal.

In making a determination, the decision-maker shall consider the comments made and the proponent's response to the comments made on the proposal.



[Return to contents page](#)

**Part 5 – Design elements
for all single house(s) and
grouped dwellings; and
multiple dwellings in areas
coded less than R40**

- 5.1 Context
- 5.2 Streetscape
- 5.3 Site planning and design
- 5.4 Building design
- 5.5 Special purpose dwellings

5.1 Context

Objectives

- (a) To ensure that **residential development** meets community expectations in regard to appearance, use and density.
- (b) To ensure that designs respond to the key natural and built features of the area and respond to the local context in terms of bulk and scale, or in the case of precincts undergoing a transition, will respond to the desired future character as stated in the **local planning framework**.
- (c) To ensure adequate provision of direct sun and ventilation for **buildings** and to ameliorate the impacts of building bulk, privacy and overshadowing on **adjoining properties**.
- (d) To ensure that **open space** (private and communal) is provided on **site** and:
 - **landscaped** to establish streetscapes;
 - provide a balanced setting and relationship to **buildings**; and
 - provide privacy, direct sun and recreational opportunities.
- (e) To ensure that **development** and design is appropriately scaled, particularly in respect to bulk and height, and is sympathetic to the scale of the **street** and surrounding **buildings**, or in precincts undergoing a transition, **development** achieves the desired future character of the area identified in **local planning framework**.



[Return to contents page](#)

Part 5 – Design elements for all single house(s) and grouped dwellings; and multiple dwellings in areas coded less than R40

- 5.1 Context
- 5.2 Streetscape
- 5.3 Site planning and design
- 5.4 Building design
- 5.5 Special purpose dwellings



Design principles

Development demonstrates compliance with the following **design principles** (P)

5.1.1 Site area

- P1.1 **Development** of the type and density indicated by the density code designated in the **scheme**.
- P1.2 The **WAPC** may approve the creation of a **lot, survey strata lot or strata lot** of a lesser minimum and/or average **site area** than that specified in **Table 1**, and the WAPC in consultation with the local government may approve the creation of a survey strata lot or strata lot for a **single house** or a **grouped dwelling** of a lesser minimum site area than that specified in **Table 1** provided that the proposed variation would be no more than five per cent less in area than that specified in **Table 1**; and
- facilitate the protection of an environmental or heritage feature;
 - facilitate the retention of a significant element that contributes toward an existing streetscape worthy of retention;
 - facilitate the **development** of lots with separate and sufficient **frontage** to more than one public **street**;
 - overcome a special or unusual limitation on the development of the land imposed by its size, shape or other feature;
 - allow land to be developed with housing of the same type and form as land in the vicinity and which would not otherwise be able to be developed; or
 - achieve specific objectives of the **local planning framework**.
- P1.3 The **WAPC**, in consultation with the local government, may approve the creation of a **survey strata lot or strata lot** for an existing authorised **grouped dwelling or multiple dwelling development** of a lesser minimum and average **site area** than that specified in **Table 1**, where, in the opinion of the WAPC or the local government, the development on the resulting survey strata or strata lots is consistent with the objectives of the relevant design elements of the R-Codes, and the orderly and proper planning of the locality.

Deemed-to-comply

Development satisfies the following **deemed-to-comply** requirements (C)

Note: The minimum and average **site areas** stipulated in Table 1 are not subject to variation except as set out in clause 5.1.1 below.

- C1.1 **Development** which complies with the **dwelling** type and **site area** requirements set out in **Table 1** and the following provisions.
- C1.2 The minimum **site area** set out in **Table 1** is calculated as follows:
- i. in the case of a **single house**, the area of a **green title lot or survey-strata lot**;
 - ii. in the case of a **grouped dwelling**, the area of land occupied by the **dwelling** itself, together with all other areas whether contiguous or not, designated for the exclusive use of the occupants of that dwelling; or
 - iii. in the case of **multiple dwellings** in areas with a coding of less than R40, the total area of the lot divided by the number of dwellings.
- C1.3 For the purposes of assessing compliance of a proposed **development** with the minimum and average **site areas** set out in **Table 1**, the following adjustments for the purposes of calculating the minimum and average site area shall apply:
- i. in the case of a lot with a corner truncation, up to a maximum of 20m² of that truncation shall be added to the area of the adjoining lot, **survey strata lot or strata lot** as the case may be (refer **Figure 1a**); or
 - ii. in the case of a rear battleaxe site, the **site area** is inclusive of the access leg provided that the area of the access leg contributes no more than 20 per cent of the site area as required by **Table 1**. Where the **battleaxe lot** (excluding the access leg) adjoins or abuts a **right-of-way** or reserve for **open space**, pedestrian access, school site or equivalent, half the width (up to a maximum depth of 2m) may be added to the site area (refer **Figure 1b**).

[Return to contents page](#)

Part 5 – Design elements for all single house(s) and grouped dwellings; and multiple dwellings in areas coded less than R40

- 5.1 Context
- 5.2 Streetscape
- 5.3 Site planning and design
- 5.4 Building design
- 5.5 Special purpose dwellings



Design principles

Development demonstrates compliance with the following **design principles** (P)

5.1.2 Street setback

- P2.1 **Buildings** set back from **street boundaries** an appropriate distance to ensure they:
- contribute to, and are consistent with, an established streetscape;
 - provide adequate privacy and **open space** for dwellings;
 - accommodate site planning requirements such as parking, **landscape** and utilities; and
 - allow safety clearances for easements for essential service corridors.
- P2.2 **Buildings** mass and form that:
- uses design features to affect the size and scale of the building;
 - uses appropriate minor projections that do not detract from the character of the streetscape;
 - minimises the proportion of the façade at ground level taken up by building services, vehicle entries and parking supply, blank **walls**, servicing infrastructure access and meters and the like; and
 - positively contributes to the prevailing **development** context and streetscape.

Deemed-to-comply

Development satisfies the following **deemed-to-comply** requirements (C)

- C1.4 Subject to clause 5.1.1 C1.3 only, the following variations to the minimum and average **site area** set out in **Table 1** may be made:
- i. for the purposes of an aged or **dependent persons' dwelling** or a **single bedroom dwelling**, the site area may be reduced by up to one third, in accordance with clauses 5.5.2 and 5.5.3 which shall only be applied where **development** is proposed;
 - ii. in the case of a **single house, grouped dwelling or multiple dwelling**; the area of a **lot, survey strata lot or strata lot** approved by the **WAPC**; or
 - iii. the area of any existing lot, survey strata lot or strata lot with permanent legal access to a public road, notwithstanding that it is less than that required in **Table 1**.
- C2.1 **Buildings** set back from the **primary street** boundary:
- i. in accordance with **Table 1**;
 - ii. corresponding to the average of the **setback** of existing **dwellings** on each adjacent property fronting the same **street**;
 - iii. reduced by up to 50 per cent provided that the area of any building, including a **carport or garage**, intruding into the setback area is compensated for by at least an equal area of **open space** between the setback line and line drawn parallel to it at twice the setback distance (refer **Figure 2a, 2b** and **2c**);
 - iv. in the case of areas coded R15 or higher, where:
 - a **grouped dwelling** has its main **frontage** to a **secondary street**;
 - a **single house** results from subdivision of an original corner lot and has its frontage to the original secondary street; or
 - a single house or grouped dwelling (where that grouped dwelling is not adjacent to the primary street), has its main frontage to a **communal street, right-of-way** or shared pedestrian or vehicle access way;

[Return to contents page](#)

Part 5 – Design elements for all single house(s) and grouped dwellings; and multiple dwellings in areas coded less than R40

- 5.1 Context
- 5.2 Streetscape
- 5.3 Site planning and design
- 5.4 Building design
- 5.5 Special purpose dwellings



Design principles

Development demonstrates compliance with the following **design principles** (P)

5.1.3 Lot boundary setback

- P3.1 **Buildings** set back from **lot** boundaries so as to:
- reduce impacts of building bulk on **adjoining properties**;
 - provide adequate direct sun and ventilation to the building and **open spaces** on the **site** and adjoining properties; and
 - minimise the extent of overlooking and resultant loss of privacy on adjoining properties.
- P3.2 **Buildings** built up to boundaries (other than the **street boundary**) where this:
- makes more effective use of space for enhanced privacy for the occupant/s or **outdoor living areas**;
 - does not compromise the **design principle** contained in clause 5.1.3 P3.1;
 - does not have any adverse impact on the amenity of the **adjoining property**;
 - ensures direct sun to **major openings to habitable rooms** and outdoor living areas for **adjoining properties** is not restricted; and
 - positively contributes to the prevailing **development** context and streetscape.

Deemed-to-comply

Development satisfies the following **deemed-to-comply** requirements (C)

- the street setback may be reduced to 2.5m, or 1.5m to a porch, verandah, balcony or the equivalent (refer **Figure 2b** and **2d**); and
- v. to provide for registered easements for essential services.
- C2.2 **Buildings** set back from the **secondary street** boundary in accordance with **Table 1**.
- C2.3 **Buildings** set back from the corner truncation boundary in accordance with the secondary street setback in Table 1.
- C2.4 A **porch, balcony, verandah**, chimney or the equivalent may project not more than 1m into the **street setback area**, and this projection is not subject to a compensating open area under clause 5.1.2 C2.1iii, provided that the total of such projections does not exceed 20 per cent of the frontage at any level (refer **Figure 2b**).
- C3.1 **Buildings** which are set back in accordance with the following provisions, subject to any additional measures in other elements of the R-Codes:
- i. buildings set back from lot boundaries in accordance with **Table 1**, **Tables 2a** and **2b** (refer to **Figure Series 3** and **4**);
 - ii. **unenclosed** areas accessible for use as **outdoor living areas**, elevated 0.5m or more above **natural ground level**, set back as though they were **major openings to habitable rooms** with a **wall height** of 2.4m above their floor level;
 - iii. separate **single house, grouped** or **multiple dwelling** buildings on the same **site**, or facing portions of the same multiple dwelling building, set back from each other as though there were a boundary between them;
 - iv. minor projections such as a chimney, other architectural feature or an eaves overhang not projecting more than 0.75m into a **setback** area; and
 - v. the stated setback distances may be reduced by half the width of an adjoining **right-of-way**, pedestrian access way, **communal street** or **battleaxe lot** access leg, to a maximum reduction of 2m (refer to **figures 2b** and **4f**).

[Return to contents page](#)

Part 5 – Design elements for all single house(s) and grouped dwellings; and multiple dwellings in areas coded less than R40

- 5.1 Context
- 5.2 Streetscape
- 5.3 Site planning and design
- 5.4 Building design
- 5.5 Special purpose dwellings

Design principles

Development demonstrates compliance with the following **design principles** (P)

Deemed-to-comply

Development satisfies the following **deemed-to-comply** requirements (C)

- C3.2 **Walls** may be built up to a **lot boundary** behind the **street setback** (specified in **Table 1** and in accordance with clauses 5.1.2, 5.2.1 and 5.2.2), within the following limits and subject to the overshadowing provisions of clause 5.4.2 and **Figure Series 11**:
- i. where the **wall** abuts an existing or simultaneously constructed wall of similar or greater dimension;
 - ii. in areas coded R20 and R25, **walls** not higher than 3.5m with an average of 3m or less, up to a maximum length of the greater of 9m or one-third the length of the balance of the **lot boundary** behind the front **setback**, to one side boundary only;
 - iii. in areas coded R30 and higher, walls not higher than 3.5m with an average of 3m or less, for two-thirds the length of the balance of the **lot boundary** behind the front **setback**, to one side boundary only; or
 - iv. where both the subject **site** and the affected adjoining **site** are created in a plan of subdivision submitted concurrently with the **development** application.
- C3.3 Where the subject site and an affected adjoining site are subject to a different density codes, in accordance with clause 5.1.3 C3.2, the length and height of the boundary **wall** on the boundary between them is determined by reference to the lower density code.

Note: The term 'up to a lot boundary' means a **wall**, on or less than 600mm, from any **lot boundary**, other than a **street boundary**.



[Return to contents page](#)

Part 5 – Design elements for all single house(s) and grouped dwellings; and multiple dwellings in areas coded less than R40

- 5.1 Context
- 5.2 Streetscape
- 5.3 Site planning and design
- 5.4 Building design
- 5.5 Special purpose dwellings



Design principles

Development demonstrates compliance with the following **design principles** (P)

5.1.4 Open space

- P4 **Development** incorporates suitable **open space** for its context to:
- reflect the existing and/or desired streetscape character or as outlined under the **local planning framework**;
 - provide access to natural sunlight for the **dwelling**;
 - reduce **building** bulk on the site, consistent with the expectations of the applicable density code and/or as outlined in the **local planning framework**;
 - provide an attractive setting for the buildings, **landscape**, vegetation and streetscape;
 - provide opportunities for residents to use space external to the dwelling for outdoor pursuits and access within/around the **site**; and
 - provide space for **external fixtures** and essential facilities.

5.1.5 Communal open space

- P5.1 **Communal open space** associated with **grouped dwellings** is provided for residents' exclusive use.
- P5.2 The location and function of **communal open space** provides privacy to users and surrounding **dwellings**.

5.1.6 Building height

- P6 **Building height** that creates no adverse impact on the amenity of **adjoining properties** or the streetscape, including road reserves and public open space reserves; and where appropriate maintains:
- adequate access to direct sun into **buildings** and appurtenant **open spaces**;
 - adequate daylight to **major openings** into **habitable rooms**; and
 - access to views of significance.

Deemed-to-comply

Development satisfies the following **deemed-to-comply** requirements (C)

- C4 **Open space** provided in accordance with **Table 1** (refer **Figure Series 6**). The **site** of the **grouped dwelling**, for the purpose of calculating the open space requirement, shall include the area allocated for the exclusive use of that **dwelling** and the proportionate share of any associated **common property**.

- C5 Where **communal open space** is provided as **common property** in a **grouped dwelling development**, the **open space** required for any grouped dwelling having legal and direct physical access to that open space may be reduced by up to 20 per cent of the required open space area provided that:
- i. the aggregate of deducted area does not exceed the area of communal open space; and
 - ii. the **outdoor living area** for any **dwelling** is not reduced in area.

- C6 Buildings which comply with **Table 3** for category B area buildings, except where stated otherwise in the **scheme**, the relevant **local planning policy**, **local structure plan** or **local development plan** (refer **Figure Series 7**).

[Return to contents page](#)

Part 5 – Design elements for all single house(s) and grouped dwellings; and multiple dwellings in areas coded less than R40

- 5.1 Context
- 5.2 Streetscape
- 5.3 Site planning and design
- 5.4 Building design
- 5.5 Special purpose dwellings

5.2 Streetscape

Objectives

- (a) To contribute towards the character of streetscapes including their views and vistas and provides security for occupants and passers-by, a **landscape** to ensure adequate shade, privacy and **open space** for occupants, and an attractive setting for the collection of **buildings**.

Design principles

Development demonstrates compliance with the following design principles (P)

5.2.1 Setback of garages and carports

- P1 The setting back of **carports** and **garages** to maintain clear sight lines along the **street** and not to detract from the streetscape or appearance of **dwellings**; or obstruct views of dwellings from the street and vice versa.

Deemed-to-comply

Development satisfies the following deemed-to-comply requirements (C)

- C1.1 **Garages** set back 4.5m from the **primary street** except that the **setback** may be reduced:
- i. in accordance with **Figure 8b** where the garage adjoins a **dwelling** provided the garage is at least 0.5m behind the dwelling alignment (excluding any **porch, verandah** or **balcony**); or
 - ii. to 3m where the garage allows vehicles to be parked parallel to the **street**. The **wall** parallel to the street must include openings.
- C1.2 **Carports** set back from the **primary street** in accordance with clause 5.1.2 C2.1.
- C1.3 **Garages** and **carports** built up to the boundary abutting a private **street** or **right-of-way** which is not the **primary** or **secondary street boundary** for the **dwelling**, with manoeuvring space of at least 6m, located immediately in front of the opening to the garage or carport and permanently available.
- C1.4 **Garages** and **carports** set back 1.5m from a **secondary street**.
- C1.5 **Carports** within the **street setback area** in accordance with clause 5.1.2 C2.1iii provided that the width of the carport does not exceed 50 per cent of the **frontage** at the **building** line and the construction allows an unobstructed view between the **dwelling** and the **street, right-of-way** or equivalent (refer to **Figure 8a**).



[Return to contents page](#)

Part 5 – Design elements for all single house(s) and grouped dwellings; and multiple dwellings in areas coded less than R40

- 5.1 Context
- 5.2 Streetscape
- 5.3 Site planning and design
- 5.4 Building design
- 5.5 Special purpose dwellings



Design principles <i>Development demonstrates compliance with the following design principles (P)</i>	Deemed-to-comply <i>Development satisfies the following deemed-to-comply requirements (C)</i>
<p>5.2.2 Garage width</p> <p>P2 Visual connectivity between the dwelling and the streetscape should be maintained and the effect of the garage door on the streetscape should be minimised whereby the streetscape is not dominated by garage doors.</p>	<p>C2 Where a garage is located in front or within 1m of the building, a garage door and its supporting structures (or a garage wall where a garage is aligned parallel to the street) facing the primary street is not to occupy more than 50 per cent of the frontage at the setback line as viewed from the street. This may be increased to 60 per cent where an upper floor or balcony extends for the full width of the garage and the entrance to the dwelling is clearly visible from the primary street (refer to Figure 8c).</p>
<p>5.2.3 Street surveillance</p> <p>P3 Buildings designed to provide for surveillance (actual or perceived) between individual dwellings and the street and between common areas and the street, which minimise opportunities for concealment and entrapment.</p>	<p>C3.1 The street elevation(s) of the dwelling to address the street with clearly definable entry points visible and accessed from the street.</p> <p>C3.2 At least one major opening from a habitable room of the dwelling faces the street and the pedestrian or vehicular approach to the dwelling.</p>
<p>5.2.4 Street walls and fences</p> <p>P4 Front fences are low or restricted in height to permit surveillance (as per Clause 5.2.3) and enhance streetscape (as per clause 5.1.2), with appropriate consideration to the need:</p> <ul style="list-style-type: none"> • for attenuation of traffic impacts where the street is designated as a primary or district distributor or integrator arterial; and • for necessary privacy or noise screening for outdoor living areas where the street is designated as a primary or district distributor or integrator arterial. 	<p>C4 Front fences within the primary street setback area that are visually permeable above 1.2m of natural ground level, measured from the primary street side of the front fence.</p>
<p>5.2.5 Sight lines</p> <p>P5 Unobstructed sight lines provided at vehicle access points to ensure safety and visibility along vehicle access ways, streets, rights-of-way, communal streets, crossovers, and footpaths.</p>	<p>C5 Walls, fences and other structures truncated or reduced to no higher than 0.75m within 1.5m of where walls, fences, other structures adjoin vehicle access points where a driveway meets a public street and where two streets intersect (refer Figure Series 9).</p>

5.2 Streetscape requirements

Part 5 – Design elements for all single house(s) and grouped dwellings; and multiple dwellings in areas coded less than R40

[Return to contents page](#)

Part 5 – Design elements for all single house(s) and grouped dwellings; and multiple dwellings in areas coded less than R40

- 5.1 Context
- 5.2 Streetscape
- 5.3 Site planning and design
- 5.4 Building design
- 5.5 Special purpose dwellings

Design principles

Development demonstrates compliance with the following **design principles** (P)

5.2.6 Appearance of retained dwelling

- P6 **Dwellings** retained as part of a **grouped** or **multiple dwelling development**, dwelling extension or redevelopment are to:
- enhance the streetscape appearance of the existing dwelling(s) retained; or
 - complement established or future built form in the locality as specified within the relevant **local planning framework**.

Deemed-to-comply

Development satisfies the following **deemed-to-comply** requirements (C)

- C6 Where an existing **dwelling** is retained as part of a **grouped dwelling development**, the appearance of the retained dwelling is upgraded externally to an equivalent maintenance standard of the new (or the rest of) the development.

5.2 Streetscape requirements



Part 5 – Design elements for all single house(s) and grouped dwellings; and multiple dwellings in areas coded less than R40

5.3 Site planning and design

Objectives

- (a) **Landscape** design should optimise function, useability, privacy and social opportunity, equitable access, respect neighbours' amenity and provide for practical establishment and maintenance.
- (b) To ensure access to housing provides for security, safety, amenity and legibility to on-site car parking areas and footpaths for residents and visitors.
- (c) To ensure each **development** makes a contribution to a streetscape by respecting the natural topography for each **site, adjoining properties** and the amenity of the locality.
- (d) To reduce the economic, environmental and social impacts associated with **site** works to facilitate housing **development** (e.g. via soil disturbance, groundwater impact and water use for dust suppression).

Design principles

Development demonstrates compliance with the following **design principles** (P)

5.3.1 Outdoor living areas

- P1.1 **Outdoor living areas** which provide spaces:
- capable of use in conjunction with a **habitable room** of the **dwelling**;
 - open to winter sun and ventilation; and
 - optimise use of the northern aspect of the **site**.
- P1.2 **Balconies** or equivalent **outdoor living areas** capable of use in conjunction with a **habitable room** of each **dwelling**, and if possible, open to winter sun.

Deemed-to-comply

Development satisfies the following **deemed-to-comply** requirements (C)

- C1.1 An outdoor living area to be provided:
- in accordance with **Table 1**;
 - behind the **street setback area**;
 - directly accessible from a **habitable room** of the **dwelling**;
 - with a minimum length and width dimension of 4m; and
 - to have at least two-thirds of the required area without permanent roof cover.
- C1.2 Each **multiple dwelling** is provided with at least one **balcony** or the equivalent, opening directly from a **habitable room** and with a minimum area of 10m² and minimum dimension of 2.4m.

[Return to contents page](#)

Part 5 – Design elements for all single house(s) and grouped dwellings; and multiple dwellings in areas coded less than R40

- 5.1 Context
- 5.2 Streetscape
- 5.3 Site planning and design
- 5.4 Building design
- 5.5 Special purpose dwellings



[Return to contents page](#)

Part 5 – Design elements for all single house(s) and grouped dwellings; and multiple dwellings in areas coded less than R40

- 5.1 Context
- 5.2 Streetscape
- 5.3 Site planning and design
- 5.4 Building design
- 5.5 Special purpose dwellings



Design principles

Development demonstrates compliance with the following **design principles** (P)

5.3.2 Landscaping

P2 **Landscaping of grouped and multiple dwelling common property and communal open spaces** that:

- contribute to the appearance and amenity of the **development** for the residents;
- contribute to the streetscape;
- enhance security and safety for residents;
- provide for microclimate; and
- retain existing trees to maintain a local sense of place.

Deemed-to-comply

Development satisfies the following **deemed-to-comply** requirements (C)

- C2 **Landscaping of grouped and multiple dwelling common property and communal open spaces** in accordance with the following:
- i. the **street setback area** developed without car parking, except for visitors' bays, and with a maximum of 50 per cent hard surface;
 - ii. separate pedestrian paths providing wheelchair accessibility connecting entries to all **buildings** with the public footpath and car parking areas;
 - iii. **landscaping** between each six consecutive external car parking spaces to include shade trees;
 - iv. lighting to pathways, and **communal open space** and car parking areas;
 - v. bin storage areas conveniently located and screened from view;
 - vi. trees which are greater than 3m in height shall be retained, in **communal open space** areas which are provided for the **development**;
 - vii. adequate sight lines for pedestrians and vehicles;
 - viii. clear line of sight between areas designated as **communal open space** and at least two **habitable room** windows;
 - ix. clothes drying areas which are secure and screened from view; and
 - x. unroofed visitors' car parking spaces to be effectively screened from the street.

[Return to contents page](#)

Part 5 – Design elements for all single house(s) and grouped dwellings; and multiple dwellings in areas coded less than R40

- 5.1 Context
- 5.2 Streetscape
- 5.3 Site planning and design
- 5.4 Building design
- 5.5 Special purpose dwellings



Design principles

Development demonstrates compliance with the following **design principles** (P)

5.3.3 Parking

- P3.1 Adequate car parking is to be provided on-site in accordance with projected need related to:
- the type, number and size of **dwellings**;
 - the availability of on-street and other off-street parking; and
 - the proximity of the proposed **development** to public transport and other facilities.
- P3.2 Consideration may be given to a reduction in the minimum number of on-site car parking spaces for **grouped** and **multiple dwellings** provided:
- available **street** parking in the vicinity is controlled by the local government; and
 - the **decision-maker** is of the opinion that a sufficient equivalent number of on-street spaces are available near the **development**.
- P3.3 Some or all of the required car parking spaces located off-site, provided that these spaces will meet the following:
- i. the off-site car parking area is sufficiently close to the **development** and convenient for use by residents and/or visitors;
 - ii. any increase in the number of **dwellings** or possible **plot ratio** being matched by a corresponding increase in the aggregate number of car parking spaces;
 - iii. permanent legal right of access being established for all users and occupiers of dwellings for which the respective car parking space is to be provided; and
 - iv. where off-site car parking is shared with other uses, the total aggregate parking requirement for all such uses, as required by the R-Codes and the **scheme** being provided. The number of required spaces may only be reduced by up to 15 per cent where the non-residential parking occurs substantially between 9 am and 5 pm on weekdays.

Deemed-to-comply

Development satisfies the following **deemed-to-comply** requirements (C)

- C3.1 The following minimum number of on-site car parking spaces is to be provided for each **single house, grouped dwelling** and **special purpose dwelling** comprising the following number of bedrooms:

Type of dwelling	Car parking spaces	
	Location A	Location B
1 bedroom dwelling	1	1
2 + bedroom dwelling	1	2
Aged persons' dwelling	1	1
Ancillary dwelling	nil	1

A = within:

- 800m of a train station on a **high frequency rail route**, measured in a straight line from the pedestrian entry to the train station platform to any part of a **lot**; or
- 250m of a **high frequency bus route**, measured in a straight line from along any part of the route to any part of a lot.

B = not within the distances outlined in A above.

- C3.2 On-site visitors car parking spaces for **grouped** and **multiple dwelling developments** provided at a rate of one space for each four **dwellings**, or part thereof in excess of four dwellings, served by a common access.
- C3.3 The minimum number of on-site car parking spaces is provided for each **multiple dwelling** as required by clause 6.3.3 C3.1.

[Return to contents page](#)

Part 5 – Design elements for all single house(s) and grouped dwellings; and multiple dwellings in areas coded less than R40

- 5.1 Context
- 5.2 Streetscape
- 5.3 Site planning and design
- 5.4 Building design
- 5.5 Special purpose dwellings



Design principles <i>Development demonstrates compliance with the following design principles (P)</i>	Deemed-to-comply <i>Development satisfies the following deemed-to-comply requirements (C)</i>
<p>5.3.4 Design of car parking spaces</p> <p>P4 Car, cycle and other parking facilities are to be designed and located on-site to be conveniently accessed, secure, consistent with the streetscape and appropriately manage stormwater to protect the environment.</p>	<p>C4.1 Car parking spaces and manoeuvring areas designed and provided in accordance with AS2890.1 (as amended).</p> <p>C4.2 Visitor car parking spaces:</p> <ul style="list-style-type: none"> • marked and clearly signposted as dedicated for visitor use only, and located close to, or visible from, the point of entry to the development and outside any security barrier; and • provide an accessible path of travel for people with disabilities. <p>C4.3 Car parking areas comprising six or more spaces provided with landscaping between each six consecutive external car parking spaces to include shade trees.</p>
<p>5.3.5 Vehicular access</p> <p>P5.1 Vehicular access provided for each development site to provide:</p> <ul style="list-style-type: none"> • vehicle access safety; • reduced impact of access points on the streetscape; • legible access; • pedestrian safety; • minimal crossovers; and • high quality landscaping features. <p>P5.2 Development with potential to be subdivided to create 20 or more green title, strata or survey strata lots provides legible internal and external connections to the surrounding road network and accommodates traffic movement and volume, visitor parking, pedestrian access, street shade trees, utility services and access for waste collection and emergency service vehicles.</p>	<p>C5.1 Access to on-site car parking spaces to be provided:</p> <ul style="list-style-type: none"> • where available, from a right-of-way available for lawful use to access the relevant lot and which is adequately paved and drained from the property boundary to a constructed street; • from a secondary street where no right-of-way exists; or • from the primary street frontage where no secondary street or right-of-way exists. <p>C5.2 Driveways to primary or secondary street provided as follows:</p> <ul style="list-style-type: none"> • driveways serving four dwellings or less not narrower than 3m at the street boundary; • no driveway wider than 6m at the street boundary and driveways in aggregate no greater than 9m for any one property. <p>C5.3 Driveways shall be:</p> <ul style="list-style-type: none"> • no closer than 0.5m from a side lot boundary or street pole; • no closer than 6m to a street corner or the point at which a carriageway begins to deviate;

[Return to contents page](#)

Part 5 – Design elements for all single house(s) and grouped dwellings; and multiple dwellings in areas coded less than R40

- 5.1 Context
- 5.2 Streetscape
- 5.3 Site planning and design
- 5.4 Building design
- 5.5 Special purpose dwellings



Design principles

Development demonstrates compliance with the following **design principles** (P)

Deemed-to-comply

Development satisfies the following **deemed-to-comply** requirements (C)

- aligned at right angles to the **street** alignment;
- located so as to avoid street trees, or, where this is unavoidable, the street trees replaced at the applicant's expense or re-planting arrangements to be approved by the **decision-maker**; and
- adequately paved and drained.

C5.4 **Driveways** designed for two way access to allow for vehicles to enter the **street** in forward gear where:

- the **driveway** serves five or more **dwellings**;
- the distance from a car space to the street is 15m or more; or
- the street to which it connects is designated as a primary distributor or integrator arterial road.

C5.5 **Driveways** for **multiple** and **grouped dwellings** where the number of **dwellings** is five or more, shall be:

- a minimum width of 4m; and
- designed to allow vehicles to pass in opposite directions at one or more points.

C5.6 **Driveways** designed for **multiple** and **grouped dwellings** may be reduced to no less than 3m where it is necessary to retain an existing **dwelling** and a passing bay or similar is provided.

C5.7 Where any proposed **development** has potential to be subdivided to create 20 or more **green title, strata** or **survey strata lots**, with each of these **lots** obtaining **driveway** access from a **communal street**, a minimum total width of 12 metres is required for the **communal street** which includes a paved vehicular carriageway with a minimum width of 5.5 metres and a pedestrian path as required by clause 5.3.6.

[Return to contents page](#)

Part 5 – Design elements for all single house(s) and grouped dwellings; and multiple dwellings in areas coded less than R40

- 5.1 Context
- 5.2 Streetscape
- 5.3 Site planning and design
- 5.4 Building design
- 5.5 Special purpose dwellings



Design principles <i>Development demonstrates compliance with the following design principles (P)</i>	Deemed-to-comply <i>Development satisfies the following deemed-to-comply requirements (C)</i>
<p>5.3.6 Pedestrian access</p> <p>P6 Legible, safe, and direct access for pedestrians to move between communal car parking areas or public streets and individual dwellings.</p>	<p>C6.1 Where a group of 10 or more dwellings is served by a communal street, either between a public street or a communal car parking area and individual dwellings; a pedestrian path separate from the vehicular access is provided, designed according to AS1428.1, provides an accessible path of travel and is at least 1.2m in width.</p> <p>C6.2 Where a communal street serves more than two dwellings and is shared by pedestrians and vehicles, the configuration of the pedestrian and vehicular routes is to provide clear sight lines, adequate lighting and paving surfaces to slow traffic to ensure pedestrian safety.</p> <p>C6.3 A communal street or pedestrian path is to be no closer than 3m to any wall with a major opening unless privacy screening is provided.</p> <p>C6.4 For multiple dwellings with only stair access, staircases are designed to access no more than two dwellings per floor level and the stairs, landings and porches are to be protected from the weather.</p> <p>C6.5 Pedestrian paths provided as required by clause 5.3.2 C2 ii.</p>
<p>5.3.7 Site works</p> <p>P7.1 Development that considers and responds to the natural features of the site and requires minimal excavation/fill.</p> <p>P7.2 Where excavation/fill is necessary, all finished levels respecting the natural ground level at the lot boundary of the site and as viewed from the street.</p>	<p>C7.1 Excavation or filling between the street and building, or within 3m of the street alignment, whichever is the lesser, shall not exceed 0.5m, except where necessary to provide for pedestrian or vehicle access, drainage works or natural light for a dwelling.</p> <p>C7.2 Excavation or filling within a site and behind a street setback line limited by compliance with building height limits and building setback requirements.</p> <p>C7.3 Subject to subclause C7.2 above, all excavation or filling behind a street setback line and within 1m of a lot boundary, not more than 0.5m above the natural ground level at the lot boundary except where otherwise stated in the scheme, local planning policy, local structure plan or local development plan.</p>

[Return to contents page](#)

Part 5 – Design elements for all single house(s) and grouped dwellings; and multiple dwellings in areas coded less than R40

- 5.1 Context
- 5.2 Streetscape
- 5.3 Site planning and design
- 5.4 Building design
- 5.5 Special purpose dwellings

Design principles

Development demonstrates compliance with the following **design principles** (P)

5.3.8 Retaining walls

P8 Retaining walls that result in land which can be effectively used for the benefit of residents and do not detrimentally affect **adjoining properties** and are designed, engineered and **landscaped** having due regard to clauses 5.3.7 and 5.4.1.

5.3.9 Stormwater management

- P9.1 Stormwater is managed on-site wherever possible either by containment or infiltration, as permitted by the soil and other **site** conditions and which reduce the export of nutrients and sediments from the site into waterways or otherwise appropriately managed prior to off-site discharge.
- P9.2 Encourage the recovery and re-use of stormwater for non-potable water applications using integrated design and fit-for-purpose water applications.

Deemed-to-comply

Development satisfies the following **deemed-to-comply** requirements (C)

- C8.1 Retaining walls set back from **lot boundaries** in accordance with the **setback** provisions of **Table 1**.
- C8.2 Where a retaining wall less than 0.5m high is required on a **lot boundary**, it may be located up to the **lot boundary** or within 1m of the **lot boundary** to allow for an area assigned to **landscaping**, subject to the provisions of clause 5.3.7.
- C9 All water draining from roofs, **driveways**, **communal streets** and other impermeable surfaces shall be directed to garden areas, sumps or rainwater tanks within the **development site** where climatic and soil conditions allow for the effective retention of stormwater on-site.



Part 5 – Design elements for all single house(s) and grouped dwellings; and multiple dwellings in areas coded less than R40

5.4 Building design

Objectives

- (a) To design **buildings** and **landscape** to minimise adverse impact on the privacy of adjoining **dwellings** and **private open space**.
- (b) To optimise comfortable living, access to sunlight and solar energy to facilitate sustainable housing **development** with particular regard for place and local conditions.
- (c) To maintain the amenity of streetscapes and views along the **street** by ensuring that associated **outbuildings** and other fixtures attached to **buildings** do not detract from the streetscape and are not visually intrusive to neighbouring properties or adjoining public spaces.

Design principles

Development demonstrates compliance with the following **design principles** (P)

5.4.1 Visual privacy

- P1.1 Minimal direct overlooking of **active habitable spaces** and **outdoor living areas** of adjacent **dwellings** achieved through:
- **building** layout and location;
 - design of **major openings**;
 - **landscape** screening of outdoor active habitable spaces; and/or
 - location of **screening** devices.
- P1.2 Maximum visual privacy to side and rear boundaries through measures such as:
- offsetting the location of ground and first floor windows so that viewing is oblique rather than direct;
 - **building** to the boundary where appropriate;
 - setting back the first floor from the side boundary;
 - providing higher or opaque and fixed windows; and/or
 - screen devices (including **landscaping**, fencing, obscure glazing, timber screens, external blinds, window hoods and shutters).

Deemed-to-comply

Development satisfies the following **deemed-to-comply** requirements (C)

- C1.1 **Major openings** and **unenclosed** outdoor **active habitable spaces**, which have a floor level of more than 0.5m above **natural ground level** and overlook any part of any other residential property behind its **street setback** line are:
- i. set back, in direct line of sight within the **cone of vision**, from the **lot boundary**, a minimum distance as prescribed in the table below (refer **Figure Series 10**):

Types of habitable rooms/ active habitable spaces	Location	
	Setback for areas coded R50 or lower	Setback for areas coded higher than R50
Major openings to bedrooms and studies	4.5m	3m
Major openings to habitable rooms other than bedrooms and studies	6m	4.5m
Unenclosed outdoor active habitable spaces	7.5m	6m

or;

- ii. are provided with permanent **screening** to restrict views within the cone of vision from any major opening or an unenclosed outdoor active habitable space.

[Return to contents page](#)

Part 5 – Design elements for all single house(s) and grouped dwellings; and multiple dwellings in areas coded less than R40

- 5.1 Context
- 5.2 Streetscape
- 5.3 Site planning and design
- 5.4 Building design
- 5.5 Special purpose dwellings



[Return to contents page](#)

Part 5 – Design elements for all single house(s) and grouped dwellings; and multiple dwellings in areas coded less than R40

- 5.1 Context
- 5.2 Streetscape
- 5.3 Site planning and design
- 5.4 Building design
- 5.5 Special purpose dwellings



Design principles

Development demonstrates compliance with the following **design principles** (P)

5.4.2 Solar access for adjoining sites

- P2.1 Effective solar access for the proposed **development** and protection of the solar access.
- P2.2 **Development** designed to protect solar access for neighbouring properties taking account the potential to overshadow existing:
- **outdoor living areas;**
 - north facing **major openings** to **habitable rooms**, within 15 degrees of north in each direction; or
 - roof mounted **solar collectors**.

Deemed-to-comply

Development satisfies the following **deemed-to-comply** requirements (C)

C1.2 Screening devices such as obscure glazing, timber screens, external blinds, window hoods and shutters are to be at least 1.6m in height, at least 75 per cent obscure, permanently fixed, made of durable material and restrict view in the direction of overlooking into any **adjoining property**.

- Note: i. Where the subject **site** and an affected adjoining site are subject to a different R-Codes, the **setback** distance is determined by reference to the lower density code.
- ii. Line of sight **setback** distances shall be measured by application of the **cone of vision** set out in **Figure Series 10**.
- iii. Line of sight **setback** distances include the width of any adjoining **right-of-way**, **communal street** or **battleaxe** leg or the like.
- iv. These provisions apply to adjoining **sites** only where that land is zoned to allow for **residential development**.

C2.1 Notwithstanding the **lot boundary setbacks** in clause 5.1.3, **development** in climatic zones 4, 5 and 6 of the State shall be so designed that its shadow cast at midday, 21 June onto any other **adjoining property** does not exceed the following limits:

- on adjoining properties coded R25 and lower – 25 per cent of the **site area**;
- on adjoining properties coded R30 to R40 inclusive – 35 per cent of the site area;
- on adjoining properties coded higher than R40 – 50 per cent of the site area.

C2.2 Where a **development site** shares its southern boundary with a **lot**, and that lot is bound to the north by another lot(s), the limit of shading for the development site set out in clause 5.4.2 C2.1 shall be reduced proportionate to the percentage of the affected property's northern boundary that the development site abuts (refer to **Figure 11b**).

Note: With regard to clause 5.4.2 C2.1 **site area** refers to the surface of the adjoining **lot** and is measured without regard to any **building** on it but taking into account its **natural ground levels**.

[Return to contents page](#)

Part 5 – Design elements for all single house(s) and grouped dwellings; and multiple dwellings in areas coded less than R40

- 5.1 Context
- 5.2 Streetscape
- 5.3 Site planning and design
- 5.4 Building design
- 5.5 Special purpose dwellings



Design principles <i>Development demonstrates compliance with the following design principles (P)</i>	Deemed-to-comply <i>Development satisfies the following deemed-to-comply requirements (C)</i>
<p>5.4.3 Outbuildings</p> <p>P3 Outbuildings that do not detract from the streetscape or the visual amenity of residents or neighbouring properties.</p>	<p>C3 Outbuildings that:</p> <ul style="list-style-type: none"> i. are not attached to a dwelling; ii. are non-habitable; iii. collectively do not exceed 60m² in area or 10 per cent in aggregate of the site area, whichever is the lesser; iv. do not exceed a wall height of 2.4m; v. do not exceed ridge height of 4.2m; vi. are not within the primary or secondary street setback area; vii. do not reduce the amount of open space required in Table 1; and viii. are set back in accordance with Tables 2a and 2b.
<p>5.4.4 External fixtures</p> <p>P4.1 Solar collectors, aerials, antennas, satellite dishes, pipes and external fixtures integrated into the design of the building to not be visually obtrusive when viewed from the street and to protect the visual amenity of surrounding properties.</p>	<p>C4.1 Solar collectors installed on the roof or other parts of buildings.</p> <p>C4.2 Television aerials of the standard type, essential plumbing vent pipes above the roof line and external roof water down pipes.</p> <p>C4.3 Other external fixtures provided they are:</p> <ul style="list-style-type: none"> i. not visible from the primary street; ii. are designed to integrate with the building; or iii. are located so as not to be visually obtrusive. <p>C4.4 Antennas, satellite dishes and the like not visible from any primary and secondary street.</p>

5.4 Building design

[Return to contents page](#)

Part 5 – Design elements for all single house(s) and grouped dwellings; and multiple dwellings in areas coded less than R40

- 5.1 Context
- 5.2 Streetscape
- 5.3 Site planning and design
- 5.4 Building design
- 5.5 Special purpose dwellings

Design principles

Development demonstrates compliance with the following **design principles** (P)

5.4.5 Utilities and facilities

- P5 External location of storeroom, rubbish collection/bin areas, and clothes drying areas where these are:
- convenient for residents;
 - rubbish collection areas which can be accessed by service vehicles;
 - screened from view; and
 - able to be secured and managed.

Deemed-to-comply

Development satisfies the following **deemed-to-comply** requirements (C)

- C5.1 An **enclosed**, lockable storage area, constructed in a design and material matching the **dwelling** where visible from the **street**, accessible from outside the dwelling, with a minimum dimension of 1.5m with an internal area of at least 4m², for each **grouped** or **multiple dwelling(s)**.
- C5.2 Where rubbish bins are not collected from the street immediately adjoining a dwelling, there shall be provision of a communal pick-up area or areas which are:
- i. conveniently located for rubbish and recycling pick-up;
 - ii. accessible to residents;
 - iii. adequate in area to store all rubbish bins; and
 - iv. fully screened from view from the **primary** or **secondary street**.
- C5.3 Clothes-drying areas screened from view from the **primary** and **secondary street**.



[Return to contents page](#)

Part 5 – Design elements for all single house(s) and grouped dwellings; and multiple dwellings in areas coded less than R40

- 5.1 Context
- 5.2 Streetscape
- 5.3 Site planning and design
- 5.4 Building design
- 5.5 Special purpose dwellings

5.5 Special purpose dwellings

Objectives

- (a) To ensure residential **development** is provided to accommodate people with or without special needs.
- (b) To provide ancillary accommodation which is independent or semi-independent to residents of the **single house**.
- (c) To ensure that **dwellings** for the aged and people with special needs can be provided within residential areas.
- (d) To provide opportunities for affordable housing.

Design principles

Development demonstrates compliance with the following **design principles** (P)

5.5.1 Ancillary dwellings

P1 **Ancillary dwelling** for people who live either independently or semi-dependently to the residents of the **single house**, sharing some **site** facilities and services and without compromising the amenity of surrounding properties.

Deemed-to-comply

Development satisfies the following **deemed-to-comply** requirements (C)

C1 **Ancillary dwelling** associated with a **single house** and on the same **lot** where:

- i. the lot is not less than 450m² in area;
- ii. there is a maximum **plot ratio area** of 70m²;
- iii. parking provided in accordance with clause 5.3.3 C3.1; and
- iv. complies with all other R-Code provisions, only as they apply to **single houses**, with the exception of clauses:
 - (a) 5.1.1 Site area;
 - (b) 5.2.3 Street surveillance (except where located on a lot with secondary street or **right-of-way** access); and
 - (c) 5.3.1 Outdoor living areas.



[Return to contents page](#)

Part 5 – Design elements for all single house(s) and grouped dwellings; and multiple dwellings in areas coded less than R40

- 5.1 Context
- 5.2 Streetscape
- 5.3 Site planning and design
- 5.4 Building design
- 5.5 Special purpose dwellings



Design principles

Development demonstrates compliance with the following **design principles** (P)

5.5.2 Aged or dependent persons' dwellings

- P2 **Aged or dependent persons' dwellings** for the housing of aged or dependent persons designed to meet the needs of aged or dependent persons; and
- reduces car dependence, i.e. is located in close proximity to public transport and services;
 - has due regard to the topography of the locality in which the **site** is located in respect to access and mobility;
 - has due regard to the availability of community facilities including parks and **open space**;
 - does not impinge upon neighbour amenity; and
 - responds to a demand for aged or dependent persons' accommodation in the locality which is recognised in the **local planning framework**.

Deemed-to-comply

Development satisfies the following **deemed-to-comply** requirements (C)

- C2.1 **Aged or dependent persons' dwellings** for the housing of aged or dependent persons shall comply with the following:
- i. a maximum **plot ratio area** of:
 - in the case of **single houses** or **grouped dwellings** – 100m²; or
 - in the case of **multiple dwellings** – 80m²;
 - ii. a minimum number of five dwellings within any single **development**;
 - iii. visitors car parking spaces at the rate of one per four dwellings, with a minimum of one space;
 - iv. the first visitors car space being a wheelchair accessible car parking space and a minimum width of 3.8m in accordance with AS4299, clause 3.7.1 (as amended);
 - v. an **outdoor living area** in accordance with the requirements of clause 5.3.1 but reducing the area required by **Table 1** by one-third; and
 - vi. comply with all other provisions of Table 1 and Part 5 as relevant.
- C2.2 All ground floor units, with a preference for all **dwellings**, to incorporate, as a minimum, the following:
- i. an accessible path of travel from the **street frontage**, car parking area or drop-off point in accordance with the requirements of AS4299 clause 3.3.2 (as amended); and
 - ii. level entry to the front entry door with preferably all external doors having level entries (diagrams, figure C1 of AS4299 [as amended]).
- C2.3 All **dwellings** to incorporate, as a minimum, the following:
- i. all external and internal doors to provide a minimum 820mm clear opening. (AS4299 clause 4.3.3 [as amended]);
 - ii. internal corridors to be a minimum 1000mm wide, width to be increased to a minimum of 1200mm in corridors with openings on side **walls**;

[Return to contents page](#)

Part 5 – Design elements for all single house(s) and grouped dwellings; and multiple dwellings in areas coded less than R40

- 5.1 Context
- 5.2 Streetscape
- 5.3 Site planning and design
- 5.4 Building design
- 5.5 Special purpose dwellings

Design principles

Development demonstrates compliance with the following **design principles** (P)

5.5.3 Single bedroom dwellings

- P3 Alternative and affordable housing options for singles or couples where it can be demonstrated that the **development**:
- reduces car dependence, i.e. is located in close proximity to public transport and convenience shopping;
 - does not impinge upon neighbour amenity; and
 - responds to a demand for single bedroom accommodation in the locality which is recognised in the **local planning framework**.

Deemed-to-comply

Development satisfies the following **deemed-to-comply** requirements (C)

- iii. a visitable toilet (AS4299, clause 1.4.12 [as amended]), preferably located within a bathroom; and
 - iv. toilet and toilet approach doors shall have a minimum 250mm nib **wall** on the door handle side of the door and provision for the installation of grab rails in accordance with AS4299, clause 4.4.4 (h) (as amended).
- C2.4 At least one occupant is a disabled or physically **dependent person** or **aged person**, or is the surviving spouse of such a person, and the owner of the land, as a condition of planning approval, lodging a section 70A notification on the certificate of title binding the owner, their heirs and successors in title requiring that this occupancy restriction be maintained.
- C3 **Single bedroom dwellings** shall comply with the following:
- i. a maximum **plot ratio area** of 70m²;
 - ii. **open space and landscaping** in accordance with the requirements of clause 5.1.4 and 5.3.2;
 - iii. parking provided in accordance with clause 5.3.3 C3.1 and C3.2;
 - iv. an **outdoor living area** in accordance with the requirements of clause 5.3.1 but reducing the area required by **Table 1** by one-third; and
 - v. comply with all other elements of Table 1 and Part 5 as relevant.

5.5 Special purpose dwellings



Part 6 – Design elements for multiple dwellings in areas coded R40 or greater; within mixed use development and activity centres

[Return to contents page](#)

Part 6 – Design elements for multiple dwellings in areas coded R40 or greater, within mixed use development and activity centres

- 6.1 Context
- 6.2 Streetscape
- 6.3 Site planning and design
- 6.4 Building design

6.1 Context

Objectives

- (a) To ensure that **development of multiple dwellings** occurs with due regard to the existing development context and/or the desired future built form for the locality as set out in the **local planning framework**.

Design principles <i>Development demonstrates compliance with the following design principles (P)</i>	Deemed-to-comply <i>Development satisfies the following deemed-to-comply requirements (C)</i>
<p>6.1.1 Building size</p> <p>P1 Development of the building is at a bulk and scale indicated in the local planning framework and is consistent with the existing or future desired built form of the locality.</p>	<p>C1 Development complies with the maximum plot ratio requirements set out in Table 4.</p>
<p>6.1.2 Building height</p> <p>P2 Building height that creates no adverse impact on the amenity of adjoining properties or the streetscape, including road reserves and public open space reserves; and where appropriate maintains:</p> <ul style="list-style-type: none"> • adequate access to direct sun into buildings and appurtenant open spaces; • adequate daylight to major openings into habitable rooms; • access to views of significance; • buildings present a human scale for pedestrians; • building façades designed to reduce the perception of height through design measures; and • podium style development is provided where appropriate. 	<p>C2 Development complies with the maximum height set out in Table 4, except where stated otherwise in the scheme, relevant local planning policy, local structure plan or local development plan (refer Figure Series 7).</p>

6.1 Context



Part 6 – Design elements for multiple dwellings in areas coded R40 or greater; within mixed use development and activity centres

[Return to contents page](#)

Part 6 – Design elements for multiple dwellings in areas coded R40 or greater, within mixed use development and activity centres

- 6.1 Context
- 6.2 Streetscape
- 6.3 Site planning and design
- 6.4 Building design

Design principles

Development demonstrates compliance with the following **design principles** (P)

6.1.3 Street setback

- P3 **Buildings** are set back from **street boundaries** (**primary** and **secondary**) an appropriate distance to ensure they:
- contribute to the desired streetscape;
 - provide articulation of the **building** on the **primary** and **secondary streets**;
 - allow for minor projections that add interest and reflect the character of the street without impacting on the appearance of bulk over the **site**;
 - are appropriate to its location, respecting the adjoining **development** and existing streetscape; and
 - facilitate the provision of weather protection where appropriate.

6.1.4 Lot boundary setbacks

- P4.1 **Buildings** set back from boundaries or adjacent buildings so as to:
- ensure adequate daylight, direct sun and ventilation for buildings and the **open space** associated with them;
 - moderate the visual impact of building bulk on a neighbouring property;
 - ensure access to daylight and direct sun for **adjoining properties**; and
 - assist with the protection of privacy between adjoining properties.
- P4.2 In **mixed use development**, in addition to the above:
- side boundary **setbacks** to retail/commercial component of the **development** is in accordance with the existing **street** context, subject to relevant **scheme** provisions.
 - retail/commercial development adjoining residential is designed to minimise the potential impacts between the two uses.

Deemed-to-comply

Development satisfies the following **deemed-to-comply** requirements (C)

- C3.1 **Development** complies with the minimum **setback** from the **primary** and **secondary street(s)** in accordance with **Table 4**.
- C3.2 **Balconies** located entirely within the property boundary.
- C4.1 In areas coded R40–R60, the **development** complies with minimum **lot boundary setback** requirements as set out in **Tables 2a** and **2b**. Subject to any additional measures in other elements of the R-codes (refer to **Figure Series 3** and **4**).
- C4.2 In areas coded R80–R160 and/or R-AC, the **development** complies with minimum **lot boundary setback** requirements as set out in **Table 5** subject to any additional measures in other elements of the R-Codes.
- C4.3 A **wall** may be built up to a **lot boundary**, where it abuts an existing or simultaneously constructed **wall** of equal or greater proportions; or a **wall** may be built up to one side **lot boundary** if it has a maximum height and average height as set out in **Table 4** and a maximum length of two-thirds the length of this boundary.
- C4.4 Separate **multiple dwellings** facing multiple dwellings on the same **site**, are to be set back from each other as though there were a boundary between them.
- C4.5 Where the subject **site** and an affected adjoining **site** are subject to different density codes, in accordance with 6.1.4 C4.3, the length and height of the boundary **wall** on the boundary between them is determined by reference to the lower density code.



Part 6 – Design elements for multiple dwellings in areas coded R40 or greater; within mixed use development and activity centres

[Return to contents page](#)

Part 6 – Design elements for multiple dwellings in areas coded R40 or greater, within mixed use development and activity centres

- 6.1 Context
- 6.2 Streetscape
- 6.3 Site planning and design
- 6.4 Building design

Design principles <i>Development demonstrates compliance with the following design principles (P)</i>	Deemed-to-comply <i>Development satisfies the following deemed-to-comply requirements (C)</i>
6.1.5 Open space P5 Open space respects existing or preferred neighbourhood character and responds to the features of the site .	C5 Development complies with minimum open space set out in Table 4 (refer to Figure Series 6).

6.1 Context



Part 6 – Design elements for multiple dwellings in areas coded R40 or greater; within mixed use development and activity centres

[Return to contents page](#)

Part 6 – Design elements for multiple dwellings in areas coded R40 or greater, within mixed use development and activity centres

- 6.1 Context
- 6.2 Streetscape
- 6.3 Site planning and design
- 6.4 Building design

6.2 Streetscape

Objectives

- (a) To respond and reinforce the existing character of the **street** and locality. **Development** should contribute towards attractive streetscapes.

Design principles <i>Development demonstrates compliance with the following design principles (P)</i>	Deemed-to-comply <i>Development satisfies the following deemed-to-comply requirements (C)</i>
<p>6.2.1 Street surveillance</p> <p>P1.1 Buildings designed to provide for surveillance (actual or perceived) between individual dwellings and the street and between common areas and the street, which minimise opportunities for concealment and entrapment.</p> <p>P1.2 In mixed use development, in addition to the above:</p> <ul style="list-style-type: none"> • blank walls minimised at street level, and where practical active frontages incorporated into the development to ensure a suitable level of casual surveillance of the public domain; and • lengths of street frontage at ground level dedicated to each tenancy limited to discourage large scale uses that reduce the level of activity along the building frontage. 	<p>C1.1 The street elevation(s) of the building to address the street, with facades generally parallel to the street and with clearly definable entry points visible and accessed from the street.</p> <p>C1.2 The building has habitable room windows or balconies that face the street.</p> <p>C1.3 Basement parking structures between a street frontage and the main front elevation are no more than 1m above natural ground level at any point.</p>
<p>6.2.2 Street walls and fences</p> <p>P2 Front fences to enable surveillance and enhance streetscape.</p>	<p>C2 Front fences within the primary street setback area that are visually permeable to 1.2m above natural ground level.</p>
<p>6.2.3 Sight lines</p> <p>P3 Unobstructed sight lines provided at vehicle access points to ensure safety and visibility along vehicle access ways, streets, rights-of-way, communal streets, crossovers, and footpaths.</p>	<p>C3 Walls, fences and other structures truncated or reduced to no higher than 0.75m within 1.5m of where walls, fences, other structures adjoin vehicle access points where a driveway meets a public street and where two streets intersect (refer to Figure Series 9).</p>

6.2 Streetscape



Part 6 – Design elements for multiple dwellings in areas coded R40 or greater; within mixed use development and activity centres

[Return to contents page](#)

Part 6 – Design elements for multiple dwellings in areas coded R40 or greater, within mixed use development and activity centres

- 6.1 Context
- 6.2 Streetscape
- 6.3 Site planning and design
- 6.4 Building design

Design principles

Development demonstrates compliance with the following **design principles** (P)

6.2.4 Building appearance

P4.1 **Buildings** designed to enhance an existing desired streetscape, where the **decision-maker** has identified the need for design controls.

P4.2 In **mixed use development**, in addition to the above:

- where mixed use development is proposed in commercial areas, the proportion of the **frontage** dedicated to the residential entrance is minimised so as to maximise the potential for active commercial frontage.
- the mixed use development is integrated such that the function of the residential and non-residential components do not conflict.
- provide weather protection in commercial areas where appropriate.

Deemed-to-comply

Development satisfies the following **deemed-to-comply** requirements (C)

C4 **Buildings** that comply with the provisions of a special control area, with the provisions of a **local planning policy** made under the **scheme** or with the provisions of the scheme, in respect of the design of **carports** and **garages**, the colour, scale, materials and roof pitch of **buildings** including **outbuildings**, the form and materials of retaining walls and the extent to which the upper levels of buildings as viewed from the street should be limited.



Part 6 – Design elements for multiple dwellings in areas coded R40 or greater; within mixed use development and activity centres

[Return to contents page](#)

Part 6 – Design elements for multiple dwellings in areas coded R40 or greater, within mixed use development and activity centres

- 6.1 Context
- 6.2 Streetscape
- 6.3 Site planning and design
- 6.4 Building design

6.3 Site planning and design

Objectives

- (a) To ensure design considerations are taken into account when the built form is design for the **site**. **Buildings** respond to the site conditions and account for the natural attributes of the site. Site planning is visually appropriate, provides for safe and convenient access, and meets the needs of residents, visitors, and neighbours.

Design principles <i>Development demonstrates compliance with the following design principles (P)</i>	Deemed-to-comply <i>Development satisfies the following deemed-to-comply requirements (C)</i>
<p>6.3.1 Outdoor living areas</p> <p>P1 Balconies or equivalent outdoor living areas capable of use in conjunction with a habitable room of each dwelling, and if possible, open to winter sun.</p>	<p>C1 Each unit is to be provided with at least one balcony or equivalent accessed directly from a habitable room with a minimum area of 10m² and a minimum dimension of 2.4m.</p>
<p>6.3.2 Landscaping</p> <p>P2 The space around the building is designed to allow for planting. Landscaping of the site is to be undertaken with appropriate planting, paving and other landscaping that:</p> <ul style="list-style-type: none"> • meets the projected needs of the residents; • enhances security and safety for residents; and • contributes to the streetscape. 	<p>C2 Landscaping of open spaces in accordance with the following:</p> <ul style="list-style-type: none"> i. the street setback areas developed without car parking, except for visitors' bays, and with a maximum of 50 per cent hard surface; ii. separate pedestrian paths providing wheelchair accessibility connecting all entries to buildings with the public footpath and car parking areas; iii. landscaping between each six consecutive external car parking spaces to include shade trees; iv. lighting provided to pathways, and communal open space and car-parking areas; and v. Clear sight lines at pedestrian and vehicle crossings.

6.3 Site planning and design



Part 6 – Design elements for multiple dwellings in areas coded R40 or greater; within mixed use development and activity centres

[Return to contents page](#)

Part 6 – Design elements for multiple dwellings in areas coded R40 or greater, within mixed use development and activity centres

- 6.1 Context
- 6.2 Streetscape
- 6.3 Site planning and design
- 6.4 Building design



Design principles

Development demonstrates compliance with the following **design principles** (P)

6.3.3 Parking

- P3.1 Adequate car and bicycle parking provided on-site in accordance with projected need related to:
- the type, number and size of **dwellings**;
 - the availability of on-street and other off-site parking; and
 - the proximity of the proposed **development** in relation to public transport and other facilities.
- P3.2 In **mixed use development**, in addition to the above:
- parking areas associated with the retail/commercial uses are clearly separated and delineated from residential parking.
- P3.3 In **activity centre** locations there may be consideration given to a reduction in on-site car parking provided:
- available **street** parking in the vicinity is controlled by local government; and
 - the **decision-maker** is of the opinion that a sufficient equivalent number of on-street spaces are available near the development.
- P3.4 Some or all of the required car parking spaces located off-site, provided that these spaces will meet the following:
- i. the off-site car parking area is sufficiently close to the **development** and convenient for use by residents and/or visitors;
 - ii. any increase in the number of **dwellings**, or possible **plot ratio**, being matched by a corresponding increase in the aggregate number of car parking spaces;
 - iii. permanent legal right of access being established for all users and occupiers of dwellings for which the respective car parking space is to be provided; and
 - iv. where off-site car parking is shared with other uses, the total aggregate parking requirement for all such uses, as required by the R-Codes and the **scheme** being provided. The number of required spaces may only be reduced by up to 15 per cent where the non-residential parking occurs substantially between 9 am and 5 pm on weekdays.

Deemed-to-comply

Development satisfies the following **deemed-to-comply** requirements (C)

- C3.1 The following minimum number of on-site car parking spaces is provided per **multiple dwelling**:

Plot ratio area and type of multiple dwelling	Car parking spaces	
	Location A	Location B
Less than 110m ² and/or 1 or 2 bedrooms	1	1.25
110m ² or greater and/or 3 or more bedrooms	1.25	1.5
Visitors car parking spaces (per dwelling)	0.25	0.25

A = within:

- 800m of a train station on a **high frequency rail route**, measured in a straight line from the pedestrian entry to the train station platform to any part of a **lot**; or
- 250m of a **high frequency bus route**, measured in a straight line from along any part of the route to any part of a **lot**.

B = not within the distances outlined in A above.

- C3.2 In addition to the above, one bicycle space to each three **dwellings** for residents; and one bicycle space to each ten dwellings for visitors, designed in accordance with AS2890.3 (as amended).

Part 6 – Design elements for multiple dwellings in areas coded R40 or greater; within mixed use development and activity centres

[Return to contents page](#)

Part 6 – Design elements for multiple dwellings in areas coded R40 or greater, within mixed use development and activity centres

- 6.1 Context
- 6.2 Streetscape
- 6.3 Site planning and design
- 6.4 Building design



Design principles

Development demonstrates compliance with the following **design principles** (P)

6.3.4 Design of car parking spaces

P4 Car, cycle and other parking facilities are to be designed and located on-site to be conveniently accessed, secure, consistent with streetscape and appropriately manage stormwater to protect the environment.

6.3.5 Vehicular access

P5 Vehicular access provided so as to minimise the number of crossovers, to be safe in use and not detract from the streetscape.

Deemed-to-comply

Development satisfies the following **deemed-to-comply** requirements (C)

- C4.1 Car parking spaces and manoeuvring areas designed and provided in accordance with AS2890.1 (as amended).
- C4.2 Visitor car parking spaces:
- marked and clearly signposted as dedicated for visitor use only, and located close to or visible from the point of entry to the **development** and outside any security barrier; and
 - provide an accessible path of travel for people with disabilities.
- C4.3 Car parking areas comprising six or more spaces provided with **landscaping** between each six consecutive external car parking spaces to include shade trees.
- C4.4 All car parking spaces except visitors' car parking spaces fully concealed from the **street** or public place.

- C5.1 Vehicle access is limited to one opening per 20m **street frontage** that is visible from the street.
- C5.2 Access to on-site car parking spaces to be provided:
- where available from a **right-of-way** available for the lawful use to access the relevant **lot** and which is adequately paved and drained from the property boundary to a constructed **street**;
 - from a **secondary street** where a right-of-way does not exist, or
 - from the **primary street frontage** where no secondary street or right-of-way exists.
- C5.3 **Driveways** designed for two way access to allow for vehicles to enter the **street** in forward gear where:
- the driveway serves five or more **dwellings**;
 - the distance from a car space to street alignment is 15m or more; or
 - the public street to which it connects is designated as a primary distributor, district distributor or integrated arterial road.
- C5.4 **Driveways** to be adequately paved and drained.

Part 6 – Design elements for multiple dwellings in areas coded R40 or greater; within mixed use development and activity centres

[Return to contents page](#)

Part 6 – Design elements for multiple dwellings in areas coded R40 or greater, within mixed use development and activity centres

- 6.1 Context
- 6.2 Streetscape
- 6.3 Site planning and design
- 6.4 Building design

Design principles <i>Development demonstrates compliance with the following design principles (P)</i>	Deemed-to-comply <i>Development satisfies the following deemed-to-comply requirements (C)</i>
<p>6.3.6 Site works</p> <p>P6.1 Development that considers and responds to the natural features of the site and requires minimal excavation/fill.</p> <p>P6.2 Where excavation/fill is necessary, all finished levels respecting the natural ground level at the boundary of the site and the adjoining properties and as viewed from the street.</p>	<p>C6.1 Excavation or filling between the street and building, or within 3m of the street alignment, whichever is the lesser, shall not exceed 0.5m, except where necessary to provide for pedestrian or vehicle access, drainage works or natural light for a dwelling.</p> <p>C6.2 Excavation or filling within a site and behind a street setback line limited by compliance with building height limits and building setback requirements.</p> <p>C6.3 Subject to clause 6.3.6 C6.2, all excavation or filling behind a street setback line and within 1m of a lot boundary shall not be more than 0.5m above the natural ground level at the lot boundary except where otherwise stated in a local planning policy or local development plan.</p>
<p>6.3.7 Retaining walls</p> <p>P7 Retaining walls that result in land which can be effectively used for the benefits of residents and do not detrimentally affect adjoining properties and are designed, engineered and adequately landscaped having regard to clauses 6.3.6 and 6.4.1.</p>	<p>C7 Where a retaining wall less than 0.5m high is required on a lot boundary, it may be located up to the lot boundary or within 1m of the lot boundary to allow for an area assigned to landscaping, subject to the provisions of clause 6.3.6.</p>
<p>6.3.8 Stormwater management</p> <p>P8.1 Stormwater is managed on-site wherever possible either by containment or by infiltration, as permitted by the soil and other site conditions, and which reduce the export of nutrients and sediments from the site into waterways or otherwise appropriately managed, prior to offsite discharge.</p> <p>P9.2 Encourage recovery and re-use of stormwater for non-potable water applications using integrated design and 'fit-for-purpose' water applications.</p>	<p>C8 All water draining from roofs, driveways, communal streets and other impermeable surfaces shall be directed to garden areas, sumps or rainwater tanks within the development site where climatic and soil conditions allow for the effective retention of stormwater on-site.</p>



Part 6 – Design elements for multiple dwellings in areas coded R40 or greater; within mixed use development and activity centres

[Return to contents page](#)

Part 6 – Design elements for multiple dwellings in areas coded R40 or greater, within mixed use development and activity centres

- 6.1 Context
- 6.2 Streetscape
- 6.3 Site planning and design
- 6.4 Building design

6.4 Building design

Objectives

- (a) To design and locate **buildings** to provide an appropriate built form that meets the needs of residents and minimises any potential impact of **development** on adjoining properties.

Design principles

Development demonstrates compliance with the following **design principles** (P)

6.4.1 Visual privacy

- P1.1 Minimal direct overlooking of **active habitable spaces** and **outdoor living areas** of adjacent **dwellings** achieved through:
- building layout, location;
 - design of major openings;
 - landscape screening of outdoor active habitable spaces; and/or
 - location of screening devices.
- P1.2 Maximum visual privacy to side and rear boundaries through measures such as:
- offsetting the location of ground and first floor windows so that viewing is oblique rather than direct;
 - **building** to the boundary where appropriate;
 - setting back the first floor from the side boundary;
 - providing higher or opaque and fixed windows; and/or
 - screen devices (including **landscaping**, fencing, obscure glazing, timber screens, external blinds, window hoods and shutters).

Deemed-to-comply

Development satisfies the following **deemed-to-comply** requirements (C)

- C1.1 **Major openings** and **unenclosed** outdoor **active habitable spaces**, which have a floor level of more than 0.5m above **natural ground level** and overlook any part of any other residential property behind its **street setback** line are:
- i. set back, in direct line of sight within the **cone of vision**, from the **lot boundary**, a minimum distance as prescribed in the table below (refer **Figure Series 10**):

Types of habitable rooms/ active habitable spaces	Location	
	Setback for areas coded R50 or lower	Setback for areas coded higher than R50
Major openings to bedrooms and studies	4.5m	3m
Major openings to habitable rooms other than bedrooms and studies	6m	4.5m
Unenclosed outdoor active habitable spaces	7.5m	6m

or;

- ii. are provided with permanent **screening** to restrict views within the cone of vision from any major opening or an unenclosed outdoor active habitable space.



Part 6 – Design elements for multiple dwellings in areas coded R40 or greater; within mixed use development and activity centres

[Return to contents page](#)

Part 6 – Design elements for multiple dwellings in areas coded R40 or greater, within mixed use development and activity centres

- 6.1 Context
- 6.2 Streetscape
- 6.3 Site planning and design
- 6.4 Building design

Design principles

Development demonstrates compliance with the following **design principles** (P)

6.4.2 Solar access for adjoining sites

P2.1 Effective solar access for the proposed **development**.

P2.2 **Development** designed to protect solar access for neighbouring properties taking account the potential to overshadow existing:

- **outdoor living areas;**
- north facing **major openings** to **habitable rooms**, within 15 degrees of north in each direction; or
- roof mounted **solar collectors**.

Deemed-to-comply

Development satisfies the following **deemed-to-comply** requirements (C)

C1.2 Screening devices such as obscure glazing, timber screens, external blinds, window hoods and shutters are to be at least 1.6m in height, at least 75 per cent obscure, permanently fixed, made of durable material and restrict view in the direction of overlooking into any **adjoining property**.

- Note: i. Where the subject **site** and an affected adjoining site are subject to a different R-Codes, the **setback** distance is determined by reference to the lower density code.
- ii. Line of sight **setback** distances shall be measured by application of the **cone of vision** set out in **Figure Series 10**.
- iii. Line of sight **setback** distances include the width of any adjoining **right-of-way, communal street** or battleaxe leg or the like.
- iv. These provisions apply to adjoining **sites** only where that land is zoned to allow for **residential development**.

C2.1 Notwithstanding the **lot boundary setbacks** in clause 6.1.4, **development** in climatic zones 4, 5 and 6 of the State shall be so designed that its shadow cast at midday, 21 June onto any other **adjoining property** does not exceed the following limits:

- on adjoining properties coded R25 and lower – 25 per cent of the **site area**;
- on adjoining properties coded R30 to R40 inclusive – 35 per cent of the **site area**;
- on adjoining properties coded R50 to R60 inclusive – 50 per cent of the **site area**.

C2.2 Where a **development site** shares its southern boundary with a **lot**, and that lot is bound to the north by another lot(s), the limit of shading for the development site set out in clause 6.4.2 C2.1 shall be reduced proportionate to the percentage of the affected property's northern boundary that the development site abuts (refer **figure 11b**).

Note: In this context **site area** refers to the surface of the adjoining **lot** and is measured without regard to any **building** on it but taking into account its **natural ground level**.



Part 6 – Design elements for multiple dwellings in areas coded R40 or greater; within mixed use development and activity centres

[Return to contents page](#)

Part 6 – Design elements for multiple dwellings in areas coded R40 or greater, within mixed use development and activity centres

- 6.1 Context
- 6.2 Streetscape
- 6.3 Site planning and design
- 6.4 Building design

Design principles

Development demonstrates compliance with the following **design principles** (P)

6.4.3 Dwelling size

P3 Each **dwelling** within the **development** is of a sufficient size to cater for the needs of the residents. The development must provide diversity in dwellings to ensure that a range of types and sizes is provided.

6.4.4 Outbuildings

P4 **Outbuildings** that do not detract from the streetscape or the visual amenity of residents or neighbouring properties.

Deemed-to-comply

Development satisfies the following **deemed-to-comply** requirements (C)

- C3.1 **Development** that contains more than 12 **dwellings** are to provide diversity in unit types and sizes as follows:
- minimum 20 per cent 1 bedroom dwellings, up to a maximum of 50 per cent of the development; and
 - minimum of 40 per cent 2 bedroom **dwellings**;
- and
- C3.2 The **development** does not contain any **dwellings** smaller than 40m² **plot ratio area**.

- C4 **Outbuildings** that:
- i. are not attached to a **dwelling**;
 - ii. are non-habitable;
 - iii. do not exceed 60m² in area or 10 per cent in aggregate of the **site area**, whichever is the lesser;
 - iv. do not exceed a **wall height** of 2.4m;
 - v. do not exceed ridge height of 4.2m;
 - vi. are not within the **primary** or **secondary street setback area**;
 - vii. do not reduce the amount of **open space** required in **Table 4**;
- and
- viii. are set back in accordance with **Tables 2a** and **2b**.

6.4 Building design



Part 6 – Design elements for multiple dwellings in areas coded R40 or greater; within mixed use development and activity centres

[Return to contents page](#)

Part 6 – Design elements for multiple dwellings in areas coded R40 or greater, within mixed use development and activity centres

- 6.1 Context
- 6.2 Streetscape
- 6.3 Site planning and design
- 6.4 Building design

Design principles

Development demonstrates compliance with the following **design principles** (P)

6.4.5 External fixtures

- P5.1 **Solar collectors**, aerials antennae, satellite dishes, pipes and **external fixtures** integrated into the design of the **building** to not be visually obtrusive when viewed from the **street** and to protect the visual amenity of surrounding properties.
- P5.2 Other **external fixtures** integrated into the design of the **building** to not be visually obtrusive when viewed from the **street** and to protect the visual amenity of residents in neighbouring properties.

6.4.6 Utilities and facilities

- P6 External location of storeroom, rubbish collection/bin areas, and clothes drying areas where these are:
- convenient for residents;
 - rubbish collection areas which can be accessed by service vehicles;
 - screened from view; and
 - able to be secured and managed.

Deemed-to-comply

Development satisfies the following **deemed-to-comply** requirements (C)

- C5.1 **Solar collectors** installed on the roof or other parts of **buildings**.
- C5.2 Television aerials of the standard type, essential plumbing vent pipes above the roof line and external roof water down pipes.
- C5.3 Other external fixtures provided they are:
- i. not visible from the **primary street**;
 - ii. are designed to integrate with the **building**; or
 - iii. are located so as not to be visually obtrusive.
- C5.4 Antennae, satellite dishes and the like not visible from the **street**.
- C6.1 An **enclosed**, lockable storage area, constructed in a design and material matching the **building/dwelling** where visible from the street, accessible from outside the dwelling, with a minimum dimension of 1.5m and an internal area of at least 4m² shall be provided for each **multiple dwelling**.
- C6.2 Where rubbish bins are not collected from the **street** immediately adjoining a **dwelling**, there shall be provision of a communal pick-up area or areas which are:
- i. conveniently located for rubbish and recycling pick-up;
 - ii. accessible to residents;
 - iii. adequate in area to store all rubbish bins; and
 - iv. fully screened from view from the **primary** or **secondary street**.
- C6.3 Clothes-drying areas screened from view from the **primary** or **secondary street**.



Part 7 – Local planning framework

[Return to contents page](#)

Part 7 – Local planning framework

- 7.1 Local planning frameworks consistent with R-Codes
- 7.2 Pre-existing local planning policies
- 7.3 Scope of local planning policies, local development plans, local structure plans and activity centre plans

7.1 Local planning framework consistent with R-Codes

The **decision-maker** shall not amend or modify the R-Codes, to provide for greater or lesser requirements unless it relates to matters expressly permitted under the R-Codes to be amended or modified.

Subject to clause 7.3, a **local planning policy, local development plan, or local structure plan** that affects **residential development** shall be consistent with the provisions of the R-Codes and may provide local objectives for housing design and **development** in so far as it guides the consideration of the **decision-maker** to judge proposals.

The local planning policy, local development plan, or local structure plan to have effect, should be available with the scheme where the decision-maker makes the scheme available.

7.2 Pre-existing local planning policies

If a properly adopted **local planning policy** which came into effect prior to the gazettal of the R-Codes is inconsistent with the R-Codes, the R-Codes prevail over the policy to the extent of the inconsistency.

7.3 Scope of local planning policies, local development plans, local structure plans and activity centre plans

7.3.1

Local planning policies, local development plans, local structure plans and activity centre plans may contain provisions that:

- (a) amend or replace the following **deemed-to-comply** provisions set out in Part 5 and/or Part 6 of the R-Codes:

Context

street setbacks	(clauses 5.1.2, 6.1.3)
lot boundary setbacks	(clauses 5.1.3 C3.2-3.3, 6.1.4 C4.2ii)
building height	(clauses 5.1.6, 6.1.2)

Streetscape

setback of garages and carports	(clause 5.2.1)
garage width	(clause 5.2.2)
street surveillance	(clauses 5.2.3, 6.2.1)
street walls and fences	(clauses 5.2.4, 6.2.2)
sight lines	(clauses 5.2.5, 6.2.3)
appearance of retained dwelling	(clause 5.2.6)

Site planning and design

site works	(clauses 5.3.7, 6.3.6 C6.3)
------------	-----------------------------

Building design

external fixtures	(clauses 5.4.4, 6.4.5 C5.3-5.4)
-------------------	---------------------------------

Special purpose dwellings

aged and dependent persons' dwelling(s)	(clause 5.5.2 C2.1ii)
---	-----------------------

- (b) augment the R-Codes by providing local housing objectives to guide judgements about the merits of proposals for any aspect of **residential development** that does not meet the requirements or is not provided for, under the R-Codes.

Amendments or replacements to **deemed-to-comply** provisions are to be consistent with the relevant **design principle**.

7.3.2

Notwithstanding clause 7.3.1, the local government may, with the approval of the **WAPC**, amend any other **deemed-to-comply** provision within the R-Codes by means of a **local planning policy, local structure plan or local development plan** where it can be demonstrated to the satisfaction of the **WAPC** that the proposed amendment:

- is warranted due to a specific need related to that particular locality or region;
- is consistent with the objectives and **design principles** of the R-Codes; and
- can be properly implemented and audited by the **decision-maker** as part of the ongoing **building approval process**.



Appendix 1 – Definitions

[Return to contents page](#)

Appendix 1 – Definitions

In the case of residential development under the R-Codes, unless the context requires otherwise, words and expressions have the meaning given to them below.

Active habitable space

Any **habitable room** with a floor area greater than 10m² and any balcony, **verandah**, terrace or other **outdoor living area** raised more than 0.5m above **natural ground level**.

Activity centre

Activity centres are community focal points. They include activities such as commercial, retail, higher density housing, entertainment, tourism, civic/community, higher education, and medical services. Activity centres vary in size and diversity and are designed to be well-serviced by public transport.

Activity centre plan

An activity centre structure plan is a statutory document required by *State Planning Policy 4.2* for strategic metropolitan centres, secondary centres, district and specialised centres but not for neighbourhood or local centres (State Planning Policy 4.2 Table 2: Activity Centre Hierarchy). It can be prepared by local government, a landowner, landowner's representative or a government agency.

Adjoining property

Any **lot**:

- on which any **dwelling** for which provision is made in the R-Codes may be constructed under the **scheme**; and
- which shares a boundary or portion of a boundary with a **lot** on which there is a proposed **residential development site** or is separated from that lot by a **right-of-way**, vehicle access way, pedestrian access way, access leg of a **battleaxe lot** or the equivalent not more than 6m in width.

Aged person

A person who is aged 55 years or over.

Ancillary dwelling

Self-contained **dwelling** on the same **lot** as a **single house** which may be attached to, integrated with or detached from the single house.

Balcony

A balustraded platform on the outside of a **dwelling** with access from an upper internal room.

Battleaxe lot

A **single house lot** that has a **frontage** for purposes of servicing and access to a public road only through a strip of connecting land containing a pedestrian and/or vehicular access way that is part of the **lot**. The term excludes a **site** that has vehicle access from a private or **communal street** or **right-of-way** connected to a public road.

Building

Any structure whether fixed or moveable, temporary or permanent, placed or erected on land, and the term includes **dwelling**s and structures appurtenant to dwellings such as carports, **garages**, **verandahs**, **patios**, **outbuildings** and retaining walls, but excludes boundary fences, **pergolas** and swimming pools.

Carport

A roofed structure designed to accommodate one or more motor vehicles **unenclosed** except to the extent that it abuts a **dwelling** or a property boundary on one side, and being without a door unless that door is **visually permeable**.

Common property

- So much of the land comprised in a strata plan as from time to time is not comprised in a **lot** shown on the plan.
- Any leasehold interest acquired by a strata company under section 18 of the *Strata Titles Act 1985*, as amended.
- The **lot** or lots shown on a **survey strata plan** as common property.

Communal open space

Open space set aside for the recreational use of the occupants of the **dwelling**s in a common **development** and does not include **driveways** or car parking areas.



Appendix 1 – Definitions

[Return to contents page](#)

[Appendix 1 – Definitions](#)

Communal street

A private carriageway providing joint access to two or more **dwelling**s in a **residential development**.

Cone of vision

The limits of outlook from any given viewpoint, applying a viewing cut off angle not less than 45 degrees, for the purposes of assessing the extent of overlooking from that point outlined in clauses 5.4.1 and 6.4.1 as set out in **Figure Series 10**.

Decision-maker

That body, organisation or authorised person legally vested with the power to make decisions, pursuant to relevant legislation, in respect of **residential development** in accordance with the R-Codes.

Deemed-to-comply

A proposal, or a component of a proposal, that complies with the deemed-to-comply provisions of the R-Codes, or an adopted **local planning policy**.

Dependant person

A person with a recognised form of disability requiring special accommodation for independent living or special care.

Design principles

Specific design objectives for each element of the R-Codes which are to be met by all **residential development** in Western Australia and are to be used in the preparation, submission and assessment of proposals for the purpose of determining their compliance with the R-Codes. A proposal is required to demonstrate compliance with design principles where it does not satisfy corresponding **deemed-to-comply** provisions.

Development

As defined under the *Planning and Development Act 2005*, as amended.

Development site

A **parent lot** in which development is proposed.

Driveway

The portion of the paved vehicle access way between a car parking area and the property boundary, excluding any associated **landscaping** or pedestrian path on either side.

Dwelling

A **building** or portion of a building being used, adapted, or designed or intended to be used for the purpose of human habitation on a permanent basis by a single person, a single family, or no more than six persons who do not comprise a single family.

Enclosed

An area bound on three or more sides by a permanent **wall** and covered in a water impermeable material.

External fixtures

These are utilities, equipment, plant or other structures which are necessary for a **dwelling** to achieve efficient, comfortable and environmentally sustainable operating outcomes and may include; **solar collectors**, rainwater storage tanks, clothes drying structures, communications and power and water infrastructure, letterboxes, or other fixtures as necessary for the residential use of the **buildings** on-site.

Frontage

The width of a **lot** at the **primary street setback** line, provided that in the case of **battleaxe** or other irregularly shaped lots, it shall be as determined by the **decision-maker**.

Garage

Any roofed structure, other than a **carport**, designed to accommodate one or more motor vehicles and attached to the **dwelling**.

Green title

A **lot** owned in fee simple issued with a certificate of title under the *Transfer of Land Act 1893*, as amended, other than a **strata lot** or a **survey strata lot**.

Grouped dwelling

A **dwelling** that is one of a group of two or more dwellings on the same **lot** such that no dwelling is placed wholly or partly vertically above another, except where special conditions of **landscape** or topography dictate otherwise, and includes a dwelling on a **survey strata** with **common property**.



Appendix 1 – Definitions

[Return to contents page](#)

[Appendix 1 – Definitions](#)

Habitable room

A room used for normal domestic activities that includes:

- a bedroom, living room, lounge room, music room, sitting room, television room, kitchen, dining room, sewing room, study, playroom, sunroom, gymnasium, fully **enclosed** swimming pool or **patio**; but excludes
- a bathroom, laundry, water closet, food storage pantry, walk-in wardrobe, corridor, hallway, lobby, photographic darkroom, clothes drying room, **verandah** and **unenclosed** swimming pool or patio and other spaces of a specialised nature occupied neither frequently nor for extended periods.

Height, building

This is the distance between the point where the base of the **wall** meets the **natural ground level** and measured to the highest point of a wall or roof of a **building** vertically above that point (for measurement guidance refer to **Figure Series 7**) excluding minor projections.

Height, wall

The vertical distance from the **natural ground level** at the boundary immediately adjacent to the **wall** to the roof or parapet at any point in accordance with **Figure Series 3** and **5**.

Heritage place

A place listed on the Commonwealth or State heritage register or the municipal heritage inventory of the **scheme**.

High frequency bus route

A public transport route with timed stops that runs a service at least every 15 minutes during week day peak periods (7 to 9am and 5 to 7pm).

High frequency rail route

A public transport route with timed stops that runs a service at least every 15 minutes during week day peak periods (7 to 9am and 5 to 7pm).

Incidental development

Development which is associated with or attached to a **dwelling** and incidental to its main residential functions.

Internal walls

Those **walls** which are wholly included within the **dwelling** including walls that abut covered **outdoor living areas** but does not include walls which are common to two dwellings in **grouped** or **multiple dwelling developments**.

Landscape, landscaping or landscaped

Land developed with garden beds, shrubs and trees, or by the planting of lawns, and includes such features as rockeries, ornamental ponds, swimming pools, barbecue areas or playgrounds and any other such area approved of by the **decision-maker** as landscaped area.

Local development plan

Also referred to as detailed area plans or similar, adopted by a **decision-maker** under a **scheme** and/or a local structure plan, to provide specific and detailed planning to guide and coordinate **development**, which may include variation(s) to the R-Codes.

Local planning framework

Comprises all strategic, statutory and policy planning documents which collectively outline the planning for an area and **development** requirements for **sites**, of the **decision-maker** and generally include a **scheme**, local planning strategy (including any housing component), local structure plans, **activity centre plans**, local development plans and local planning policies.

Local planning policy

Any policy prepared by a local government in accordance with the procedures set out in the **scheme**.

Local planning strategy

A document which supports the preparation and review of a **scheme** in accordance with section 12, 12A and 12B of the Town Planning Regulations 1967.

Local structure plan

A statutory planning document prepared and approved under the provisions of the **scheme** which provides a framework for the planning and coordination of land use, **development** and subdivision.

Lot

For **single houses**, a lot as defined under the *Planning and Development Act 2005*, as amended. For **multiple** or **grouped dwellings**, the **parent lot**.

Lot boundary

The boundary between a lot and any other parcel of land, excluding a **street boundary**.



Appendix 1 – Definitions

[Return to contents page](#)

[Appendix 1 – Definitions](#)

Major opening

A window, door or other opening in the exterior **wall** of a **habitable room** that provides external means of light or view for that room or space, but does not include an opening or openings that:

- in aggregate do not exceed 1m² in any such wall, (provided that adjoining or contiguous windows at the junction of two walls forming an internal angle of 90 degrees or less shall be aggregated); or
- are glazed in an obscure material and are not able to be opened; or have a sill height not less than 1.6m above floor level.

Minor projection

- In relation to the height of a **building**: a chimney, vent pipe, aerial or other appurtenance of like scale;
- In relation to a **wall**: a rainwater pipe, vent pipe, eaves overhang, cornice or other moulding or decorative feature, provided that the projection does not exceed 0.75m measured horizontally.

Mixed use development

Buildings that contain commercial and other non-residential uses in conjunction with residential **dwelling**s in a multiple dwelling configuration.

Multiple dwelling

A **dwelling** in a group of more than one dwelling on a **lot** where any part of the **plot ratio area** of a dwelling is vertically above any part of the plot ratio area of any other but:

- does not include a **grouped dwelling**; and
- includes any dwellings above the ground floor in a mixed use development.

Natural ground level

The levels on a **site** which precede the proposed **development**, excluding any site works unless approved by the **decision-maker** or established as part of subdivision of the land preceding development.

Open space

Generally that area of a **lot** not occupied by any **building** and includes:

- open areas of accessible and useable flat roofs and outdoor living areas above natural ground level;
- areas beneath eaves;
- **verandahs**, patios or other such roofed structures not more than 0.5m above natural ground level, **unenclosed** on at least two sides, *and* covering no more than 10 per cent of the **site area** or 50m² whichever is the lesser;
- unroofed open structures such as pergolas;
- uncovered **driveways** (including access aisles in car parking areas) and uncovered car parking spaces;

but excludes:

- non-accessible roofs, verandahs, balconies and outdoor living areas over 0.5m above natural ground level; and/or
- covered car parking spaces and covered walkways, areas for rubbish disposal, stores, **outbuildings** or plant rooms.

Outdoor living area

The area external to a **single house, grouped or multiple dwelling** to be used in conjunction with that **dwelling** such that it is capable of active or passive use and is readily accessible from the dwelling.

Outbuilding

An **enclosed** non-habitable structure that is detached from any **dwelling**.

Parent lot

Relating to **multiple or grouped dwellings**, the **lot** inclusive of common areas to which the **strata scheme**, as defined under the *Strata Titles Act 1985, as amended*, relates.

Patio

An **unenclosed** structure covered in a water impermeable material which may or may not be attached to a **dwelling**.

Pergola

An open-framed structure covered in a water permeable material or unroofed, which may or may not be attached to a **dwelling**.

Plot ratio

The ratio of the gross **plot ratio area of buildings** on a **development site** to the area of land in the **site** boundaries.



Appendix 1 – Definitions

[Return to contents page](#)

Appendix 1 – Definitions

Plot ratio area

The gross total area of all floors of **buildings** on a **development site**, including the area of any **internal** and external **walls** but not including:

- the areas of any lift shafts;
- stairs or stair landings common to two or more **dwellings**;
- machinery, air conditioning and equipment rooms;
- space that is wholly below **natural ground level**;
- areas used exclusively for the parking of wheeled vehicles at or below **natural ground level**;
- storerooms;
- lobbies, bin storage areas, passageways to bin storage areas or amenities areas common to more than one **dwelling**; or
- **balconies**, eaves, **verandahs**, courtyards and roof terraces.

Primary street

Unless otherwise designated by the local government, the sole or principal public road that provides access to the major entry (front door) to the **dwelling**.

Private open space

Open space set aside on a **lot** for the exclusive use of the occupants of the **dwelling** to which it abuts and excludes car parking spaces and access ways.

Porch

A roofed open platform attached to the front of a dwelling.

Residential building

A **building** or portion of a building, together with rooms and **outbuildings** separate from such building but incidental thereto; such building being used or intended, adapted or designed to be used for the purpose of human habitation:

- temporarily by two or more persons; or
- permanently by seven or more persons, who do not comprise a single family, but does not include a hospital or sanatorium, a prison, a hotel, a motel or a residential school.

Residential development

Development of permanent accommodation for people, and may include all **dwellings**, the residential component of mixed-use development, and residential buildings proposing permanent accommodation.

Right-of-way

A laneway, private **street**, or other use of land (not being a public street or road) that provides vehicular access to a **development site**.

Scheme

The local planning scheme that specifies zoning and **development** standards gazetted pursuant to the *Planning and Development Act 2005*, as amended.

Screening

Permanently fixed external perforated panels or trellises composed of solid or obscured translucent panels.

Secondary street

In the case of a **site** that has access from more than one public road, a road that is not the **primary street** but which intersects with or adjoins that road.

Setback

The horizontal distance between a **wall** at any point and an adjacent **lot boundary**, measured at right angles (90 degrees) to the boundary.

Single bedroom dwelling

A **dwelling** that contains a living room and no more than one other **habitable room** that is capable of use as a bedroom.

Single house

A **dwelling** standing wholly on its own **green title** or **survey strata lot**, together with any easement over adjoining land for support of a **wall** or for access or services and excludes dwellings on titles with areas held in **common property**.

Site

- In the case of a single house, the **green title** or **survey strata lot** on which it stands.
- In the case of a **grouped dwelling**, the area occupied by the **dwelling** together with any area allocated (whether by way of strata title or otherwise) for the exclusive use or benefit of that dwelling.
- In the case of a **multiple dwelling development**, the **lot** (or **parent lot** where the lot is subdivided under strata title) on which the dwellings stand.



Appendix 1 – Definitions

[Return to contents page](#)

[Appendix 1 – Definitions](#)

Site area

The area of land required for the construction of a **dwelling** to satisfy the requirements of the R-Codes.

Solar collectors

Solar collecting components of the following: thermal heating systems, photovoltaic systems and skylights.

Special purpose dwelling

Includes **ancillary dwelling, aged or dependent persons' dwelling** or a **single bedroom dwelling**.

Strata lot

One or more cubic spaces forming part of a **lot** in a strata scheme.

Strata plan

Has the meaning given by section 4 (1a) of the *Strata Titles Act 1985*, as amended.

Strata scheme

Has the meaning given under the *Strata Titles Act 1985*, as amended.

Street

Any public road, **communal street**, private street, **right-of-way** or other shared access way that provides the principal **frontage** to a **dwelling** but does not include an access leg to a single **battleaxe lot**.

Street setback

The horizontal distance between the street alignment and a **building**, measured at right angles (90 degrees) to the street alignment.

Street setback area

The area between the street alignment and the street setback line as set out in **Tables 1** and **4** or as established in a particular case in accordance with the provisions of design element 5.2 or 6.2.

Street boundary

The boundary between the land comprising a street and the land that abuts thereon.

Survey strata

A **lot** and associated **common property** as shown on a registered survey strata plan prepared in accordance with section 4(1b) of the *Strata Titles Act 1985*, as amended.

Survey strata lot

Land that is shown as an ordinary **lot** consisting of two or more lots on a survey strata plan and does not include a lot shown as **common property** prepared in accordance with section 3 of the *Strata Titles Act 1985*, as amended.

Survey strata plan

A registered survey strata plan prepared in accordance with section 4 (1b) of the *Strata Titles Act 1985*, as amended and which shows the whole or any part of the land comprised in the plan as divided into two or more **lots**.

Survey strata scheme

The manner of division of the land comprised in a survey strata scheme into **lots** and **common property** and the manner of the allocation of unit entitlements, rights and obligations among the lots.

Unenclosed

An area bounded on no more than two sides by a permanent **wall** and covered in a water impermeable material.

Verandah

A roofed open platform attached to a **dwelling**.

Visually permeable

In reference to a **wall**, gate, door or fence that the vertical surface has:

- continuous vertical or horizontal gaps of 50mm or greater width occupying not less than one third of the total surface area;
- continuous vertical or horizontal gaps less than 50mm in width, occupying at least one half of the total surface area in aggregate; or
- a surface offering equal or lesser obstruction to view; as viewed directly from the street.

Wall

The vertical external face of a constructed **building** comprising solid building material and including enclosures to **verandahs** and **balconies**.

WAPC

The Western Australian Planning Commission.



Tables

[Return to contents page](#)

Table 1

– General site requirements for all single house(s) and grouped dwellings and multiple dwellings in areas coded less than R40

Tables 2a and 2b

– Boundary setbacks

Table 3

– Maximum building heights

Table 4

– General site requirements for multiple dwellings in areas coded R40 or greater, within mixed use development and/or activity centres

Table 5

– Lot boundary setbacks for sites with an R-Code of R80 and greater than or R-AC

Table 1: General site requirements for all single house(s) and grouped dwellings; and multiple dwellings in areas coded less than R40

1 R-Code	2 Dwelling type	3 Minimum site area per dwelling (m ²) ◆	4 Minimum lot area/rear battleaxe (m ²) ▼	5 Minimum frontage (m) ▼	6 Open space		7 Minimum setbacks (m)		
					min total (% of site)	min outdoor living (m ²)	primary street	secondary street ●	other/rear
R2	Single house or grouped dwelling	Min 5000	-	50	80	-	20	10	10
R2.5	Single house or grouped dwelling	Min 4000	-	40	80	-	15	7.5	7.5
R5	Single house or grouped dwelling	Min 2000	-	30	70	-	12	6	*/6
R10	Single house or grouped dwelling	Min 875 Av 1000	925	20	60	-	7.5	3	*/6
	Multiple dwelling	1000	-	-	60	-	7.5	3	*/6
R12.5	Single house or grouped dwelling	Min 700 Av 800	762.5	17	55	-	7.5	2	*/6
	Multiple dwelling	800	-	-	55	-	7.5	2	*/6
R15	Single house or grouped dwelling	Min 580 Av 666	655	12	50	-	6	1.5	*/6
	Multiple dwelling	666	-	-	50	-	6	1.5	*
R17.5	Single house or grouped dwelling	Min 500 Av 571	587.5	12	50	36	6	1.5	*
	Multiple dwelling	571	-	-	-	-	6	1.5	*
R20	Single house or grouped dwelling	Min 350 Av 450	450	10	50	30	6	1.5	*
	Multiple dwelling	450	-	-	50	-	6	1.5	*
R25	Single house or grouped dwelling	Min 300 Av 350	425	8	50	30	6	1.5	*
	Multiple dwelling	350	-	-	50	-	6	1.5	*
R30	Single house or grouped dwelling	Min 260 Av 300	410	-	45	24	4	1.5	*
	Multiple dwelling	300	-	-	45	-	4	1.5	*
R35	Single house or grouped dwelling	Min 220 Av 260	395	-	45	24	4	1.5	*
	Multiple dwelling	260	-	-	45	-	4	1.5	*
R40	Single house or grouped dwelling	Min 180 Av 220	380	-	45	20	4	1	*
R50	Single house or grouped dwelling	Min 160 Av 180	380	-	40	16	2	1	*
R60	Single house or grouped dwelling	Min 120 Av 150	380	-	40	16	2	1	*
R80	Single house or grouped dwelling	Min 100 Av 120	380	-	30	16	1	1	*

All standards for single house or grouped dwellings within R100, R160 and R-AC areas are as for the R80 Code

Legend

- ◆ subject to variations permitted under clause 5.1.1 C1.4
- ▼ only applies to **single houses**
- **secondary street:** includes **communal street**, private street, **right-of-way** as street
- indicated not applicable
- * see **Tables 2a and 2b** and clause 5.1.3
- Av. average **site** area



4.5m

Tables

[Return to contents page](#)

Table 1

– General site requirements for all single house(s) and grouped dwellings and multiple dwellings in areas coded less than R40

Tables 2a and 2b

– Boundary setbacks

Table 3

– Maximum building heights

Table 4

– General site requirements for multiple dwellings in areas coded R40 or greater, within mixed use development and/or activity centres

Table 5

– Lot boundary setbacks for sites with an R-Code of R80 and greater than or R-AC

Table 2a: Boundary setbacks - Walls with no major openings

		Wall length (m)													
		9 or less	10	11	12	13	14	15	16	17	18	19	20	25	Over 25
Wall height (m)															
3.5 or less*		1	1.5	1.5	1.5	1.5	1.5	1.5	1.5	1.5	1.5	1.5	1.5	1.5	1.5
4.0		1.1	1.5	1.5	1.5	1.5	1.5	1.5	1.6	1.6	1.6	1.6	1.7	1.7	1.8
4.5		1.1	1.5	1.5	1.5	1.5	1.5	1.6	1.7	1.7	1.7	1.7	1.7	1.8	2.0
5.0		1.1	1.5	1.5	1.5	1.5	1.6	1.7	1.8	1.8	1.8	1.8	1.9	2.0	2.3
5.5		1.2	1.5	1.5	1.5	1.6	1.7	1.8	1.9	1.9	2.0	2.0	2.1	2.3	2.5
6.0		1.2	1.5	1.5	1.5	1.6	1.8	1.9	2.0	2.0	2.1	2.1	2.2	2.4	2.8
6.5		1.2	1.5	1.5	1.6	1.7	1.9	2.0	2.1	2.1	2.2	2.2	2.3	2.7	3.0
7.0		1.2	1.5	1.5	1.6	1.8	2.0	2.1	2.2	2.2	2.3	2.4	2.5	2.8	3.3
7.5		1.3	1.5	1.6	1.7	1.9	2.1	2.2	2.3	2.3	2.4	2.5	2.6	3.0	3.5
8.0		1.3	1.5	1.6	1.7	1.9	2.1	2.2	2.4	2.4	2.5	2.6	2.7	3.1	3.8
8.5		1.4	1.6	1.7	1.8	2.0	2.2	2.3	2.5	2.6	2.7	2.8	2.9	3.3	4.1
9.0		1.4	1.7	1.7	1.8	2.0	2.3	2.4	2.6	2.7	2.8	2.9	3.0	3.6	4.3
9.5		1.4	1.7	1.8	1.9	2.1	2.4	2.5	2.7	2.8	2.9	3.0	3.2	3.8	4.6
10.0		1.5	1.8	1.9	2.0	2.2	2.4	2.6	2.8	2.9	3.0	3.1	3.3	4.0	4.8

Take the nearest higher value for all intermediate **height** and length values.

* Possible nil **setback** in accordance with clause 5.1.3.

Table 2b: Boundary setbacks - Walls with major openings

		Wall length (m)													
		9 or less	10	11	12	13	14	15	16	17	18	19	20	25	Over 25
Wall height (m)															
3.5 or less*		1.5	1.5	1.5	1.5	1.5	1.5	1.5	1.5	1.5	1.5	1.5	1.5	1.5	1.5
4.0		1.8	2.0	2.2	2.4	2.5	2.7	2.8	3.0	3.1	3.3	3.4	3.6	4.5	5.0
4.5		2.0	2.2	2.4	2.6	2.8	3.0	3.1	3.2	3.4	3.7	3.8	4.0	4.8	5.4
5.0		2.3	2.5	2.6	2.8	3.0	3.2	3.3	3.5	3.7	3.9	4.0	4.2	5.1	5.7
5.5		2.5	2.7	2.9	3.1	3.3	3.5	3.6	3.7	3.9	4.2	4.4	4.6	5.5	6.0
6.0		2.8	3.0	3.1	3.3	3.5	3.8	3.9	4.0	4.2	4.5	4.7	4.9	5.7	6.3
6.5		3.0	3.2	3.4	3.6	3.8	4.0	4.1	4.2	4.4	4.7	4.9	5.2	6.1	6.6
7.0		3.3	3.5	3.7	3.8	4.1	4.3	4.4	4.6	4.8	5.0	5.2	5.5	6.4	7.0
7.5		3.5	3.7	3.9	4.2	4.4	4.6	4.7	4.9	5.1	5.3	5.5	5.7	6.6	7.3
8.0		3.8	4.0	4.2	4.4	4.6	4.8	5.0	5.2	5.4	5.6	5.8	6.0	7.0	7.7
8.5		4.0	4.3	4.5	4.7	4.9	5.2	5.3	5.5	5.7	5.9	6.1	6.3	7.3	8.0
9.0		4.3	4.5	4.7	5.0	5.2	5.4	5.6	5.8	6.0	6.2	6.4	6.6	7.6	8.3
9.5		4.6	4.8	5.0	5.2	5.4	5.7	5.8	5.0	6.2	6.4	6.6	6.9	8.0	8.7
10.0		4.8	5.0	5.2	5.4	5.7	6.0	6.1	6.3	6.5	6.7	6.9	7.2	8.2	9.0

Take the nearest higher value for all intermediate **height** and length values.



Tables

[Return to contents page](#)

Table 1

– General site requirements for all single house(s) and grouped dwellings and multiple dwellings in areas coded less than R40

Tables 2a and 2b

– Boundary setbacks

Table 3

– Maximum building heights

Table 4

– General site requirements for multiple dwellings in areas coded R40 or greater, within mixed use development and/or activity centres

Table 5

– Lot boundary setbacks for sites with an R-Code of R80 and greater than or R-AC

Table 3: Maximum building heights

Maximum building heights (i)	Category		
	A	B	C
	Tops of external wall (roof above) (ii)	3m	6m
Top of external wall (concealed roof)	4m	7m	10m
Top of pitched roof (iii) (iv)	6m	9m	12m

- i. Category B will apply unless a **scheme**, the relevant **local planning policy, local structure plan** or **local development plan** requires the application of category A (generally single level **development**) or category C (development on three levels) or an alternative standard.
- ii. Gable **walls** above eaves height:
 - less than 9m long: exempted
 - greater than 9m long: add one third of the height of the gable, between the eaves and the apex of the gable wall, to the eaves height.
- iii. Applies to ridges greater than 6m long. Short ridges: add 0.5m height for each 2m reduction in length.
- iv. Applies to roof pitches up to 25 degrees. In some localities steeper pitches may be required and greater height permitted in accordance with the provisions of the **scheme**, the relevant **local planning policy, local structure plan** or **local development plan**.

Table 4: General site requirements for multiple dwellings in areas coded R40 or greater, within mixed use development and/or activity centres

1 R-Code	2 Maximum plot ratio	3 Minimum open space (% of site)	4 Minimum primary street boundary setback (m)	5 Secondary street setback (m)	6 Maximum height ^a (m)			7 Maximum height of walls built up to boundary (m)		
					Top of external wall	Top of external wall (concealed roof)	Top of pitched roof	Maximum height	Average	
										R40
R50	0.6	45	2	2	9	10	12	3.5	3	
R60	0.7	45	2	2	9	10	12	3.5	3	
R80	1.0	(b)	2	2	12	13	15	7	6	
R100	1.25	(b)	2	2	12	13	15	7	6	
R160	2.0	(b)	2	2	15	16	18	7	6	
Multiple dwellings within mixed use development and activity centres										
R-AC0(b)	(b)	(b)	(b)	(b)	(b)	(b)	(b)	(b)	(b)	(b)
R-AC1	3.0(c)	(c)	2	2(c)	27(c)	28(c)	30(c)	14(c)	12(c)	
R-AC2	2.5(c)	(c)	2	2(c)	20(c)	21(c)	23(c)	10.5(c)	9(c)	
R-AC3(d)	2.0(c)	(c)	2	2(c)	18(c)	19(c)	21(c)	7(c)	6(c)	

Notes:

- (a) Maximum height as defined in Table 4 does not supersede any height controls which are defined in **scheme**, the relevant **local planning policy, local structure plan** or **local development plan**.
- (b) Refer to local structure plan or local development plan which sets out **development** requirements.
- (c) Controls can be varied when R-AC is introduced into a scheme.
- (d) Residential elements of **mixed use development** within non R-Coded land is to be assessed against R-AC3 provisions.
- (e) **Residential development** in land zoned "R-IC" is to be assessed under the provisions of R-AC3.
- (f) **Plot ratio** defined within R-AC R-Codes are for the residential component within mixed use development and **activity centres**.



4.5m

Tables

[Return to contents page](#)

Table 1

– General site requirements for all single house(s) and grouped dwellings and multiple dwellings in areas coded less than R40

Tables 2a and 2b

– Boundary setbacks

Table 3

– Maximum building heights

Table 4

– General site requirements for multiple dwellings in areas coded R40 or greater, within mixed use development and/or activity centres

Table 5

– Lot boundary setbacks for sites with an R-Code of R80 and greater than or R-AC

Table 5: Lot boundary setbacks for sites with an R-Code of R80 and greater or R-AC

	Width of the lot in metres (m)		
	≤14	15	≥16
Side setback in metres (m)	3	3.5	4

Notes:

- (a) **Setbacks** do not apply to eaves and sun shading devices.
- (b) Setback requirements in Table 5 do not supersede any controls which are defined in a **scheme, local structure plan, activity centre plan, local development plan, local planning strategy or local planning policy.**



Figure Series 1 – Site area measurement

[Return to contents page](#)

Figure Series 1
– Site area measurement

Figure Series 2
– Street setbacks

Figure Series 3
– Wall height for lot boundary setbacks

Figure Series 4
– Wall length for lot boundary setbacks

Figure Series 5
– Lot boundary walls

Figure Series 6
– Open space

Figure Series 7
– Building height

Figure Series 8
– Garages and carports

Figure Series 9
– Sight lines

Figure Series 10
– Privacy

Figure Series 11
– Overshadowing

Intent

The purpose of Figure Series 1 is to illustrate additional areas that may be included in **site area** for the purposes of clause 5.1.1 C1.3.

Figure 1a – Truncation area may be included (clause 5.1.1 C1.3i)

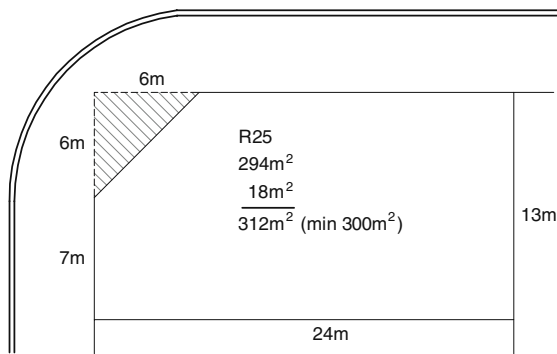

Figure 1b – Areas of rear laneways or reserves (to a maximum of 2m) are included in minimum site area for single house on battleaxe lot (clause 5.1.1 C1.3ii)

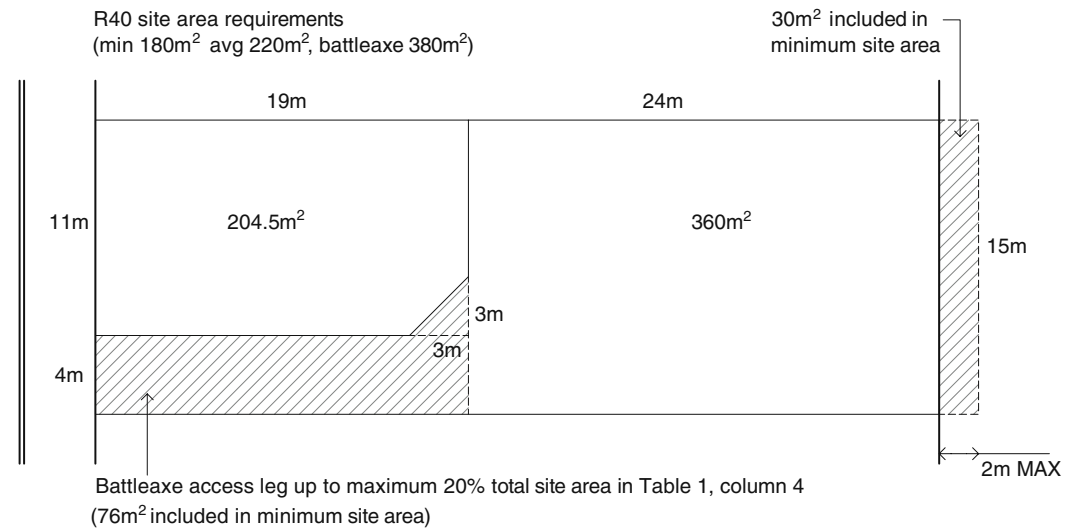

Figure Series 2 – Street setbacks

[Return to contents page](#)

Figure Series 1
– Site area measurement

Figure Series 2
– Street setbacks

Figure Series 3
– Wall height for lot boundary setbacks

Figure Series 4
– Wall length for lot boundary setbacks

Figure Series 5
– Lot boundary walls

Figure Series 6
– Open space

Figure Series 7
– Building height

Figure Series 8
– Garages and carports

Figure Series 9
– Sight lines

Figure Series 10
– Privacy

Figure Series 11
– Overshadowing

Intent

The purpose of Figure Series 2 is to illustrate how to determine **street setbacks** for the purposes of clause 5.1.2.

Development within the **street setback** is to be designed to limit the visual intrusion into views from neighbouring dwellings into the **street** and from along the street.

Figures

- S1 **Primary street setback** distance (Table 1)
- S2 Distance behind the **primary street setback**, equal to S1
- S3 Side boundary **setback** (Table 2a and 2b)
- S4 Maximum reduced **primary street setback** (half of S1)
- S5 Maximum 1m projection as per clause 5.1.2 C2.4
- A1 Area of building forward of **primary street setback**
- A2 Compensating open area behind **primary street setback**
- L1 Maximum 20 per cent of building façade

Figure 2a – Measuring primary street setbacks (clause 5.1.2 C2.1 iii)

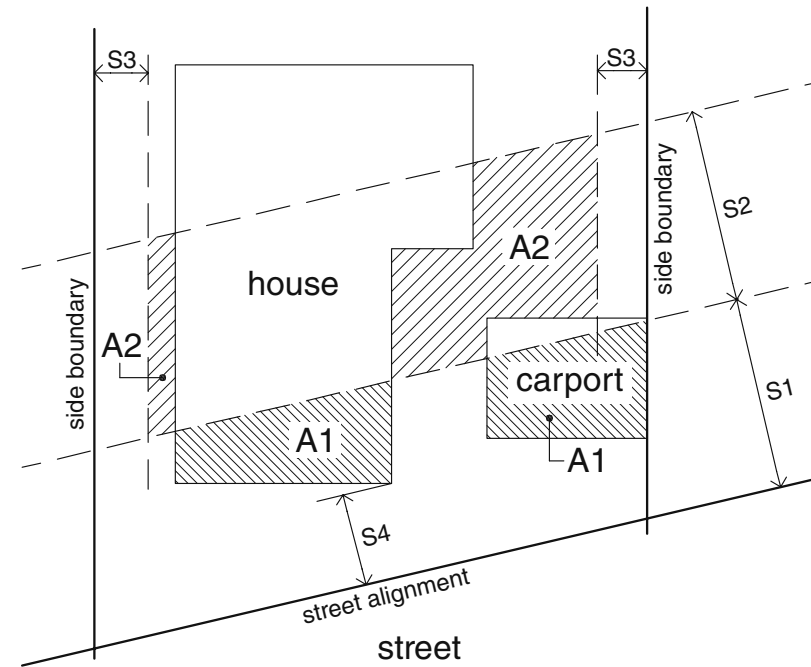

Figure Series 2 – Street setbacks

[Return to contents page](#)

Figure Series 1
– Site area measurement

Figure Series 2
– Street setbacks

Figure Series 3
– Wall height for lot boundary setbacks

Figure Series 4
– Wall length for lot boundary setbacks

Figure Series 5
– Lot boundary walls

Figure Series 6
– Open space

Figure Series 7
– Building height

Figure Series 8
– Garages and carports

Figure Series 9
– Sight lines

Figure Series 10
– Privacy

Figure Series 11
– Overshadowing

Figure 2b – Measuring minor projections into primary street setback (clause 5.1.2 C2.4)

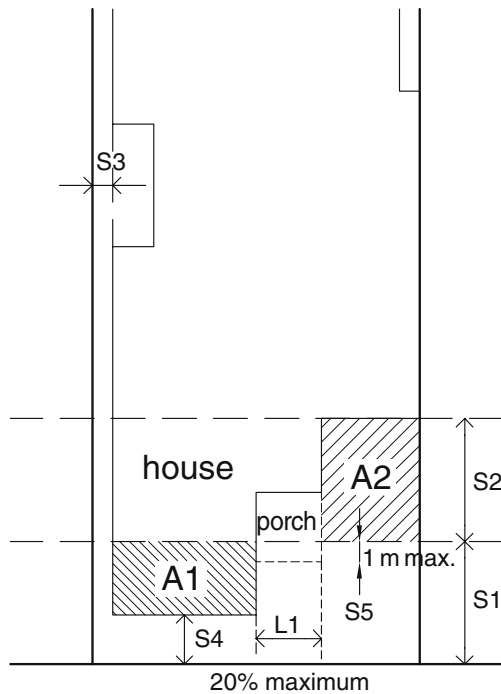

Figure 2c – Measuring street setback for garages and carports (clause 5.2.1)

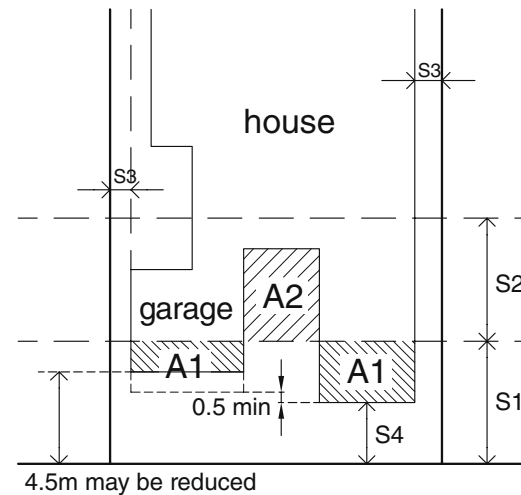
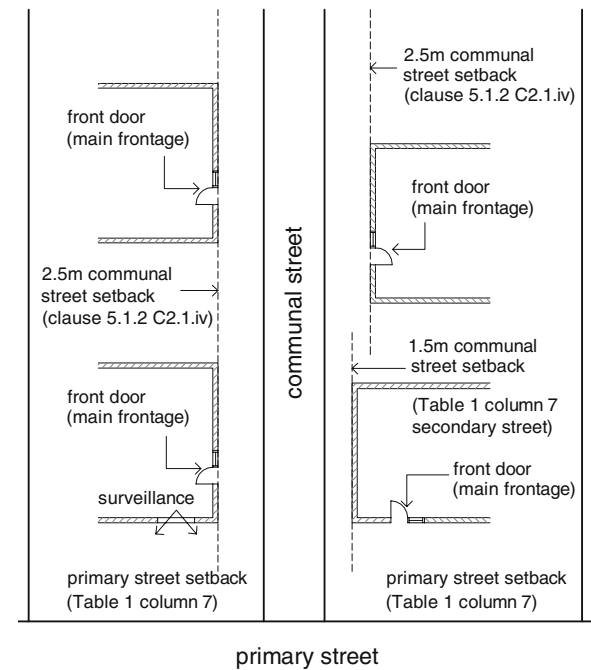

Figure 2d – Measuring communal street setbacks (clause 5.1.2 C2.1 iv)



- S1 **Primary street setback** distance (Table 1)
- S2 Distance behind the **primary street setback**, equal to S1
- S3 Side boundary **setback** (Table 2a and 2b)
- S4 Maximum reduced **primary street setback** (half of S1)

- S5 Maximum 1m projection as per clause 5.1.2 C2.4
- A1 Area of building forward of **primary street setback**
- A2 Compensating open area behind **primary street setback**
- L1 Maximum 20 per cent of building façade



Figure Series 3 – Wall height for lot boundary setbacks

[Return to contents page](#)

Figure Series 1
– Site area measurement

Figure Series 2
– Street setbacks

Figure Series 3
– Wall height for lot boundary setbacks

Figure Series 4
– Wall length for lot boundary setbacks

Figure Series 5
– Lot boundary walls

Figure Series 6
– Open space

Figure Series 7
– Building height

Figure Series 8
– Garages and carports

Figure Series 9
– Sight lines

Figure Series 10
– Privacy

Figure Series 11
– Overshadowing

Intent

The purpose of Figure Series 3 is to illustrate the correct method for measuring the height of various **walls** and **buildings** for the purposes of clauses 5.1.3 C3.1i and 6.1.4 C4.1.

Figure 3a – Cross section, flat site

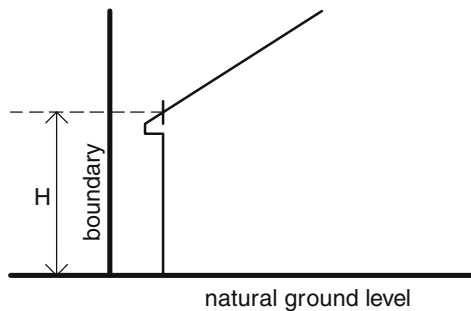

Figure 3b – Cross section, sloping site

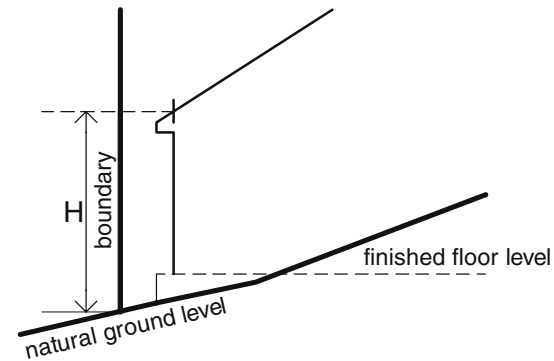
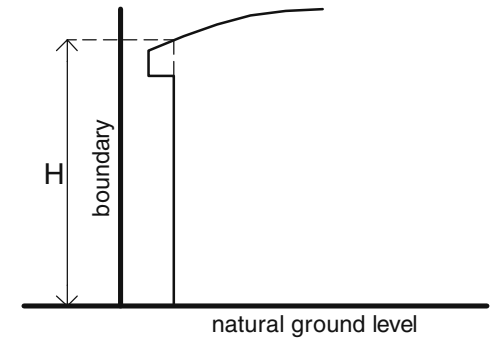

Figure 3c – Cross section, flat site



Notes

H = The height of the **wall** for the measurement of **setbacks** is measured from the **natural ground level** at the **lot boundary** adjacent to the wall to the highest point of the **building** vertically above that point where the wall touches the roof (Figure 3a-3h, 3b and 3c).

Where the **lot boundary** adjacent to the **wall** is lower than the **natural ground level** at the base of the wall, the greater height is used (Figure 3b, 3d, 3f and 3h).

Where the **lot boundary** adjacent to the **wall** is higher than the **natural ground level** at the base of the wall, the lesser height is used (Figure 3e and 3g).



Figure Series 3 – Wall height for lot boundary setbacks

[Return to contents page](#)

- Figure Series 1**
– Site area measurement
- Figure Series 2**
– Street setbacks
- Figure Series 3**
– Wall height for lot boundary setbacks
- Figure Series 4**
– Wall length for lot boundary setbacks
- Figure Series 5**
– Lot boundary walls
- Figure Series 6**
– Open space
- Figure Series 7**
– Building height
- Figure Series 8**
– Garages and carports
- Figure Series 9**
– Sight lines
- Figure Series 10**
– Privacy
- Figure Series 11**
– Overshadowing

Figure 3d – Cross section, sloped site

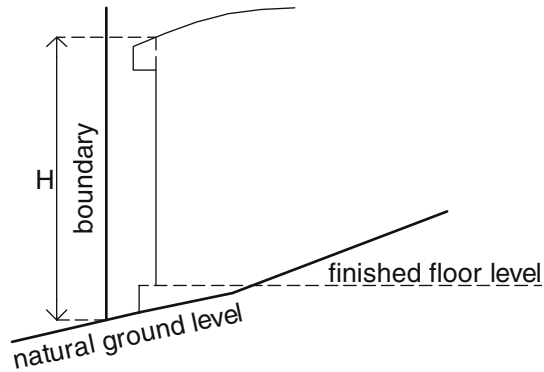

Figure 3e – Cross section, sloped site

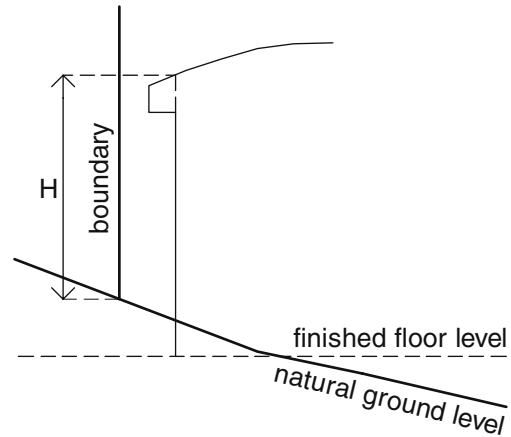

Figure 3f – Cross section, alternate levels with existing retaining

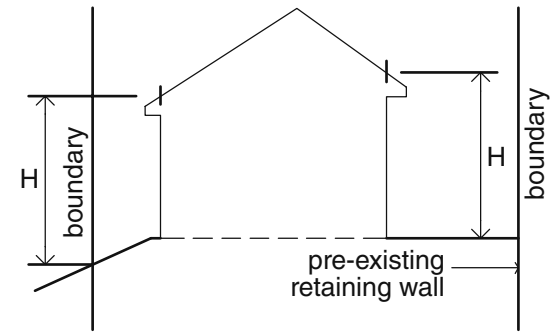

Figure 3g – Cross section, alternate levels with fill

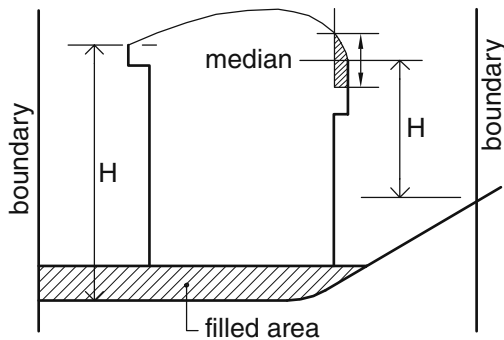
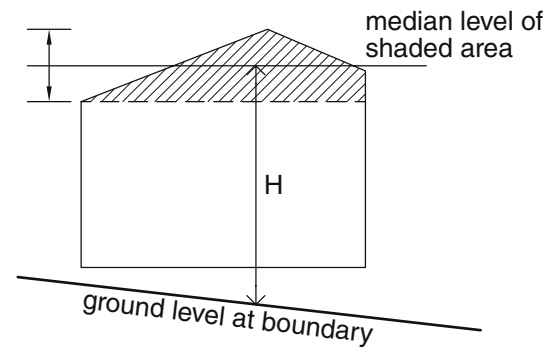

Figure 3h – Cross section, skillion roof



Notes

H = The height of the **wall** for the measurement of **setbacks** is measured from the **natural ground level** at the **lot boundary** adjacent to the wall to the highest point of the **building** vertically above that point where the wall touches the roof (Figure 3a-3h, 3b and 3c).

Where the **lot boundary** adjacent to the **wall** is lower than the **natural ground level** at the base of the wall, the greater height is used (Figure 3b, 3d, 3f and 3h).

Where the **lot boundary** adjacent to the **wall** is higher than the **natural ground level** at the base of the wall, the lesser height is used (Figure 3e and 3g).



Figure Series 4 – Wall length for lot boundary setbacks

[Return to contents page](#)

Figure Series 1
– Site area measurement

Figure Series 2
– Street setbacks

Figure Series 3
– Wall height for lot boundary setbacks

Figure Series 4
– Wall length for lot boundary setbacks

Figure Series 5
– Lot boundary walls

Figure Series 6
– Open space

Figure Series 7
– Building height

Figure Series 8
– Garages and carports

Figure Series 9
– Sight lines

Figure Series 10
– Privacy

Figure Series 11
– Overshadowing

Intent

The purpose of Figure Series 4 is to illustrate the method for measuring the appropriate **setback** for a length of **wall** adjacent to a **lot boundary** for the purposes of clauses 5.1.3 C3.1 and 6.1.4 C4.1.

Figure 4a – Articulated walls with major openings (where wall height exceeds 3.5m)

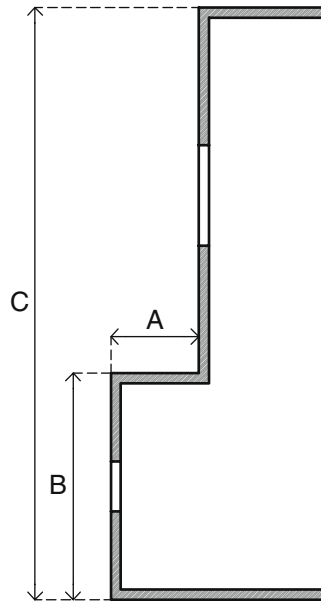

Figure 4b – Portions of wall without major openings

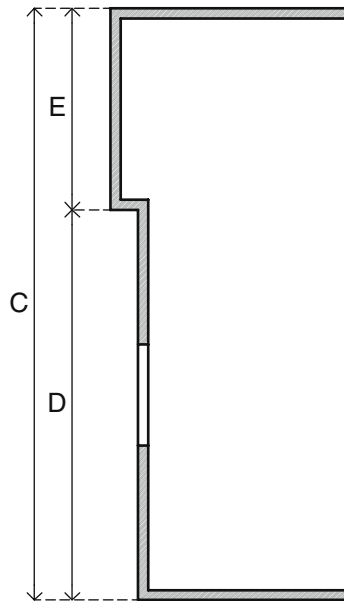
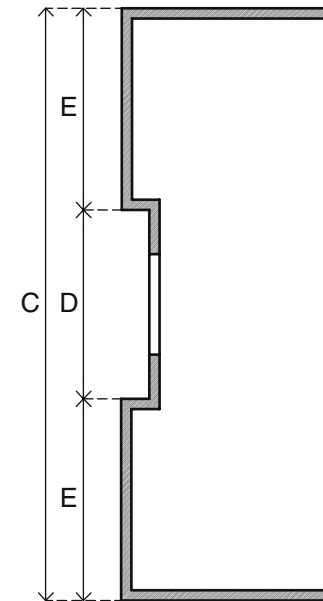

Figure 4c – Walls with multiple articulations



Notes

For the purposes of calculating **setback**, the length of **wall** means the total horizontal dimension of the side of the **building** nearest the **lot boundary**. **Setbacks** shall be determined in accordance with the following and with reference to **Tables 2a** and **2b**, subject to the privacy requirements of clauses 5.4.1 and 6.4.1:

- 4a Where A is more than 3m, B shall be treated as a separate **wall**, providing that the length C shall be the basis for determining the **setback** of the rest of the side of the **building**.
- 4b Where the side of a **building** includes one portion of a wall without a **major opening** (such as E), the setback shall be determined independently providing the setback of the rest of that side of the **building** (D) is determined on the basis of the total length C.
- 4c Where the side of the **building** includes two or more portions of a wall without a major opening (such as E) their setbacks shall be determined independently of each other provided they are separated from one another by a distance (D) of more than 4m (in the case of **wall heights** of 6m or less) and an additional 1m for every 3m increase in height.

The **setback** of D shall be determined on the basis of the total length (C).

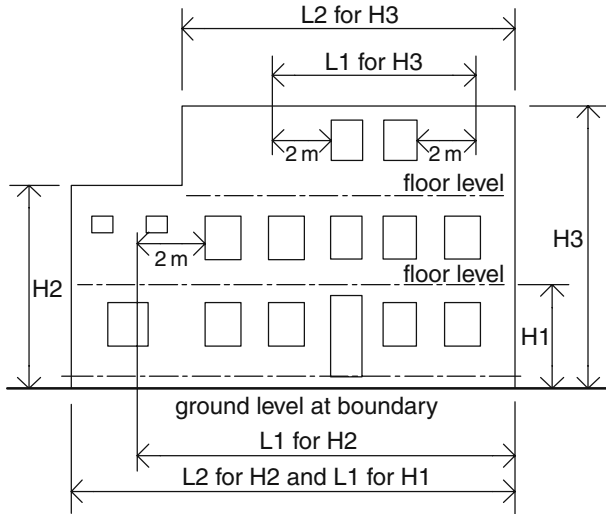

Figure Series 4 – Wall length for lot boundary setbacks

[Return to contents page](#)

- Figure Series 1**
– Site area measurement
- Figure Series 2**
– Street setbacks
- Figure Series 3**
– Wall height for lot boundary setbacks
- Figure Series 4**
– Wall length for lot boundary setbacks
- Figure Series 5**
– Lot boundary walls
- Figure Series 6**
– Open space
- Figure Series 7**
– Building height
- Figure Series 8**
– Garages and carports
- Figure Series 9**
– Sight lines
- Figure Series 10**
– Privacy
- Figure Series 11**
– Overshadowing

Figure 4d – Measurement of length of upper floor walls for calculating setbacks



Notes

L1 Length of **walls** on the ground floor is determined as per Figures 4a-c.

Length of **walls** with **major openings** on upper floors is determined as the lesser of the actual length of wall or from a point 2m beyond each major opening.

Length for **walls** without **major openings** on upper floors is determined as per Figures 4a-c.

Figure 4e – Boundary setbacks for walls greater than Table 2a and 2b

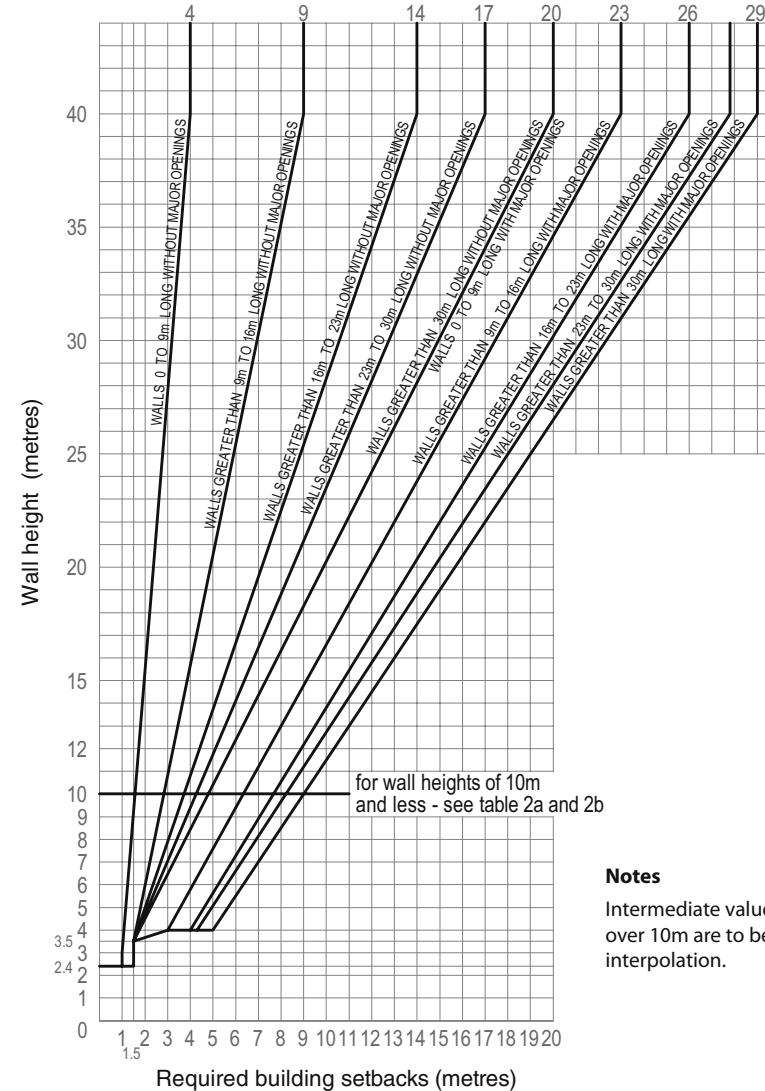

Notes

Intermediate values for **wall heights** over 10m are to be determined by interpolation.

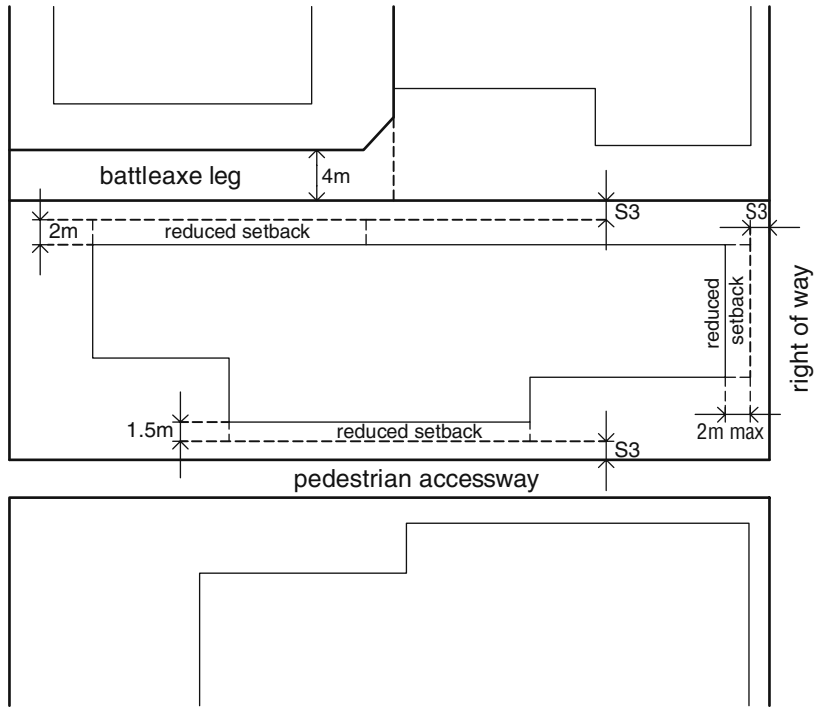

Figure Series 4 – Wall length for lot boundary setbacks

[Return to contents page](#)

- Figure Series 1**
– Site area measurement
- Figure Series 2**
– Street setbacks
- Figure Series 3**
– Wall height for lot boundary setbacks
- Figure Series 4**
– Wall length for lot boundary setbacks
- Figure Series 5**
– Lot boundary walls
- Figure Series 6**
– Open space
- Figure Series 7**
– Building height
- Figure Series 8**
– Garages and carports
- Figure Series 9**
– Sight lines
- Figure Series 10**
– Privacy
- Figure Series 11**
– Overshadowing

Figure 4f – Reduced boundary setbacks (clause 5.1.3 C3.1)



Notes

S3 Side boundary setback (Table 2a and 2b).

Setbacks can be reduced by half the width of adjoining **battleaxe lot** legs, pedestrian access ways or **rights-of-way** to a maximum of 2m.



Figure Series 5 – Lot Boundary walls

[Return to contents page](#)

Figure Series 1
– Site area measurement

Figure Series 2
– Street setbacks

Figure Series 3
– Wall height for lot boundary setbacks

Figure Series 4
– Wall length for lot boundary setbacks

Figure Series 5
– Lot boundary walls

Figure Series 6
– Open space

Figure Series 7
– Building height

Figure Series 8
– Garages and carports

Figure Series 9
– Sight lines

Figure Series 10
– Privacy

Figure Series 11
– Overshadowing

Intent

The purpose of Figure Series 5 is to illustrate the correct method for measuring the height of various **walls** for the purposes of clause 5.1.3.

Figure 5a – Elevation – flat site

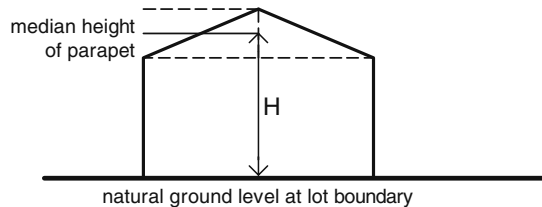

Figure 5b – Elevation – sloped site

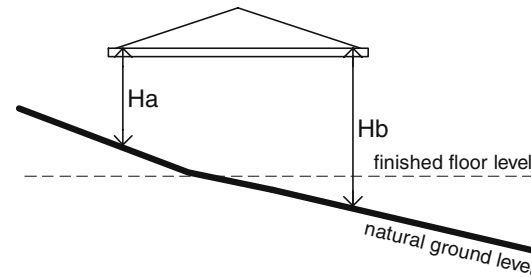
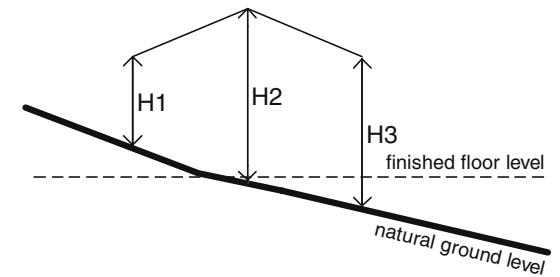

Figure 5c – Elevation – sloped site



Notes

The height of a **lot boundary wall** shall be measured to the point immediately above the **natural ground level** below.

5a Where the boundary **wall** is not consistent in height for its length, or comprises a pitch, the height shall be measured as the midpoint between the lowest point immediately above the **natural ground level** below and the highest point immediately above the natural ground level below.

5b Where the boundary is sloped the height shall be the average of the heights of the **wall** at its highest and lowest point above **natural ground level** (Ha and Hb).

5c Where the boundary is sloped and the boundary wall is not consistent in height for its length, or comprises a pitch, the height shall be the average of H1, H2, and H3, where H2 is the maximum height above **natural ground level**, and H1 and H3 are the height above natural ground level at each end of the **wall**.



Figure Series 6 – Open space

[Return to contents page](#)

Figure Series 1
– Site area measurement

Figure Series 2
– Street setbacks

Figure Series 3
– Wall height for lot boundary setbacks

Figure Series 4
– Wall length for lot boundary setbacks

Figure Series 5
– Lot boundary walls

Figure Series 6
– Open space

Figure Series 7
– Building height

Figure Series 8
– Garages and carports

Figure Series 9
– Sight lines

Figure Series 10
– Privacy

Figure Series 11
– Overshadowing

Intent

The purpose of Figure Series 6 is to illustrate the appropriate design and functionality of portions of the site which may be used for **open space**.

Figure 6a – Measuring open space (clauses 5.1.4 C5 and 6.1.5 C5)

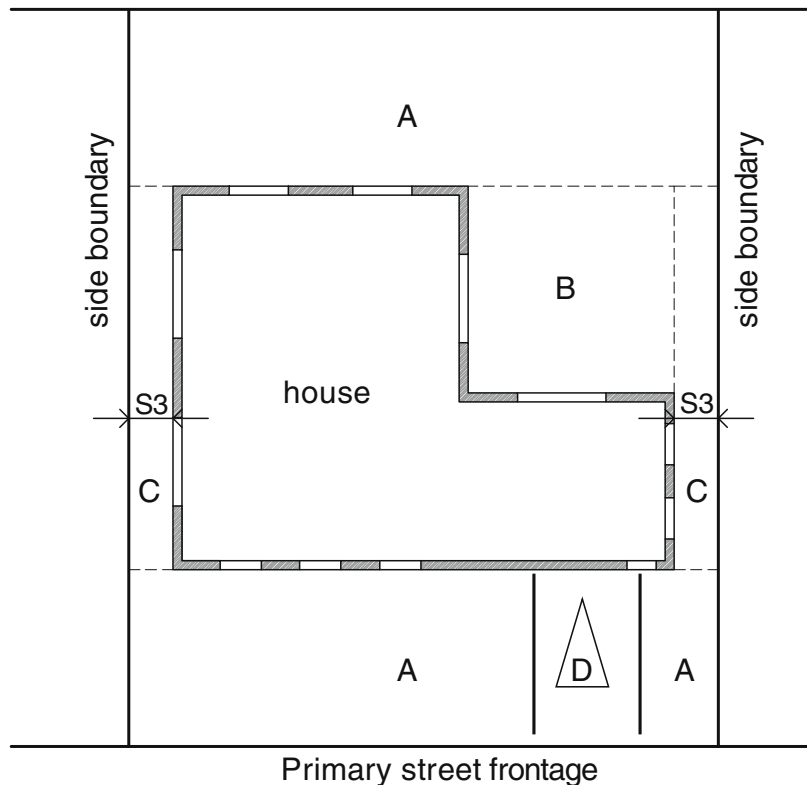

Notes

S3 Side boundary **setback** (Table 2a and 2b)

A Uncovered **open space**

B **Unenclosed**, covered **outdoor living area** (to a maximum 10 per cent **site area** or 50m², whichever is lesser)

C Side **setback** area

D Uncovered **driveway** or uncovered car parking spaces

Open space = A + B + C + D



Figure Series 7 – Building height

[Return to contents page](#)

Figure Series 1
– Site area measurement

Figure Series 2
– Street setbacks

Figure Series 3
– Wall height for lot boundary setbacks

Figure Series 4
– Wall length for lot boundary setbacks

Figure Series 5
– Lot boundary walls

Figure Series 6
– Open space

Figure Series 7
– Building height

Figure Series 8
– Garages and carports

Figure Series 9
– Sight lines

Figure Series 10
– Privacy

Figure Series 11
– Overshadowing

Intent

The purpose of Figure Series 7 is to show how to measure building height for the purposes of clauses 5.1.6 and 6.1.2.

Figure 7a – Measuring building height

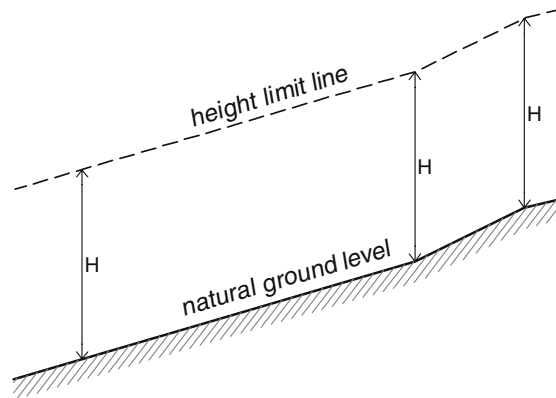
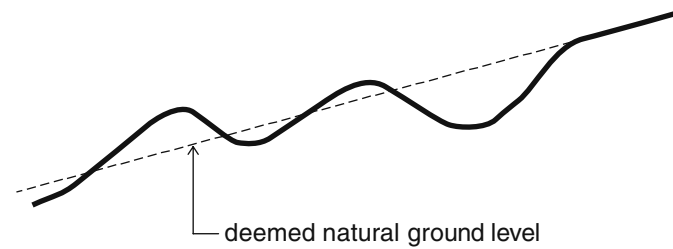

Figure 7b – Deemed natural ground level



Notes

- The height of a **building** is taken as the highest point at any part of the **development** immediately above **natural ground level**.
- Where **natural ground level** varies across the **site**, deemed natural ground level is to be used.



Figure Series 8 – Garages and carports

[Return to contents page](#)

Figure Series 1
– Site area measurement

Figure Series 2
– Street setbacks

Figure Series 3
– Wall height for lot boundary setbacks

Figure Series 4
– Wall length for lot boundary setbacks

Figure Series 5
– Lot boundary walls

Figure Series 6
– Open space

Figure Series 7
– Building height

Figure Series 8
– Garages and carports

Figure Series 9
– Sight lines

Figure Series 10
– Privacy

Figure Series 11
– Overshadowing

Intent

The purpose of Figure Series 8 is to illustrate the determination of **primary street setbacks** and the measurement of width for **garages** and **carports** for the purposes of clauses 5.2.1 and 5.2.2.

Figure 8a – Carport setbacks (clause 5.2.1 C1.5)

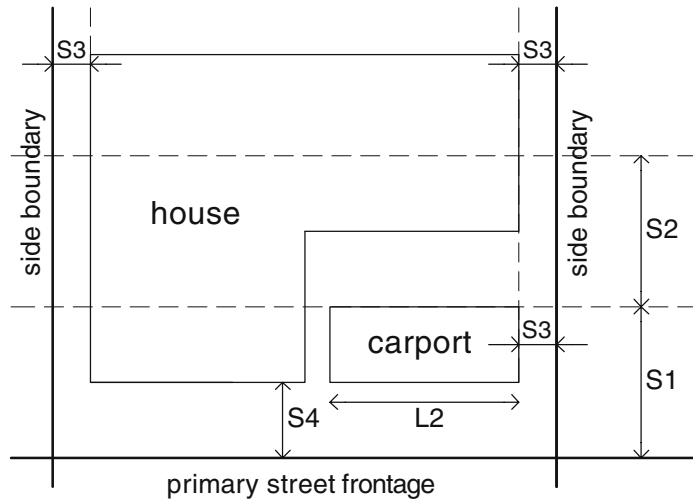

Figure 8b – Garage setbacks (clause 5.2.1 C1.1)



Notes

- S1 **Primary street setback** distance (**Table 1**)
- S2 Distance behind the **primary street setback**, equal to S1
- S3 Side boundary **setback** (**Table 2a** and **2b**)
- S4 Maximum reduced setback (half S1)
- S6 Minimum 4.5m as per clause 5.2.1 C1.1
- L2 Maximum 50 per cent of **frontage**

The area of the **carport** or **garage** forward of the primary street setback is to be compensated by open space behind the setback in accordance with clause 5.1.2 C2.1iii and **Figure 2a**.

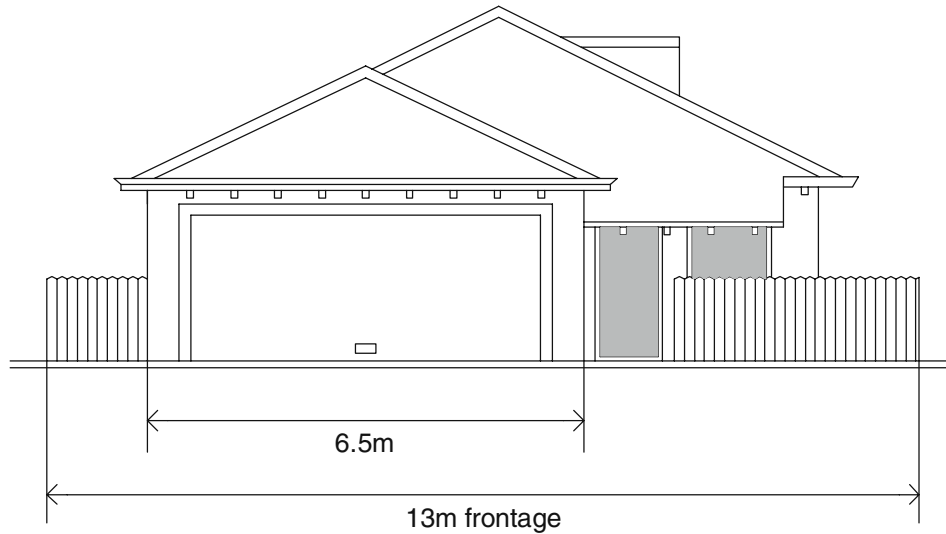

Figure Series 8 – Garages and carports

[Return to contents page](#)

- Figure Series 1**
– Site area measurement
- Figure Series 2**
– Street setbacks
- Figure Series 3**
– Wall height for lot boundary setbacks
- Figure Series 4**
– Wall length for lot boundary setbacks
- Figure Series 5**
– Lot boundary walls
- Figure Series 6**
– Open space
- Figure Series 7**
– Building height
- Figure Series 8**
– Garages and carports
- Figure Series 9**
– Sight lines
- Figure Series 10**
– Privacy
- Figure Series 11**
– Overshadowing

Figure 8c – Garage doors (clause 5.2.2 C2)



garage doors and its supporting structures not more than 50% of frontage



Figure Series 9 – Sight lines

[Return to contents page](#)

Figure Series 1
– Site area measurement

Figure Series 2
– Street setbacks

Figure Series 3
– Wall height for lot boundary setbacks

Figure Series 4
– Wall length for lot boundary setbacks

Figure Series 5
– Lot boundary walls

Figure Series 6
– Open space

Figure Series 7
– Building height

Figure Series 8
– Garages and carports

Figure Series 9
– Sight lines

Figure Series 10
– Privacy

Figure Series 11
– Overshadowing

Intent

The purpose of Figure Series 9 is to illustrate areas to be kept clear for the purposes of clause 5.2.5 C5.

Figure 9a – Locations of truncations or reduced fence height

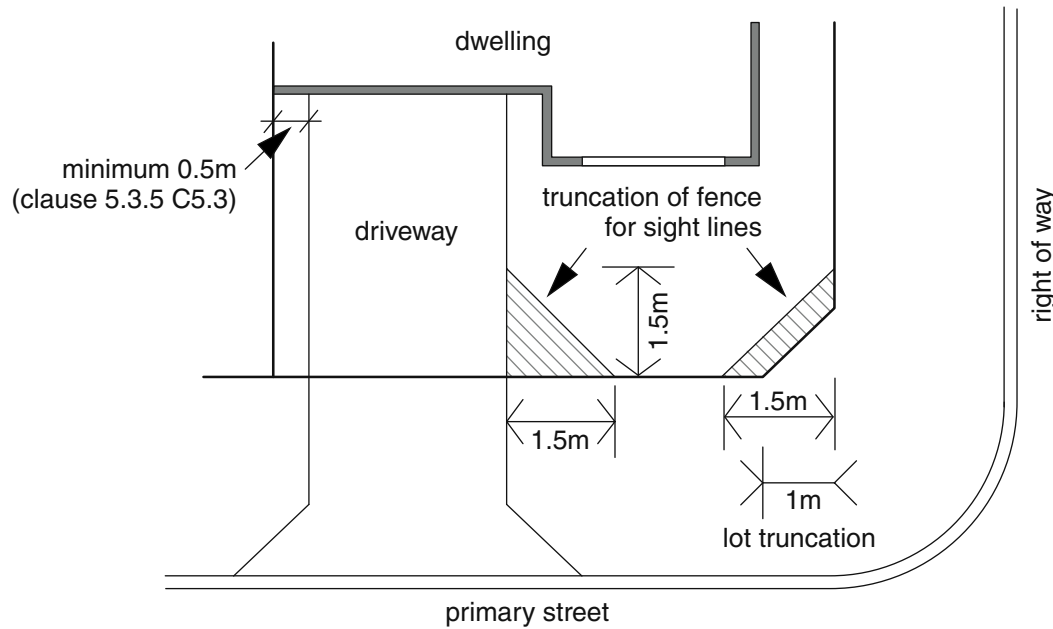

Figure Series 10 – Privacy

[Return to contents page](#)

- Figure Series 1**
– Site area measurement
- Figure Series 2**
– Street setbacks
- Figure Series 3**
– Wall height for lot boundary setbacks
- Figure Series 4**
– Wall length for lot boundary setbacks
- Figure Series 5**
– Lot boundary walls
- Figure Series 6**
– Open space
- Figure Series 7**
– Building height
- Figure Series 8**
– Garages and carports
- Figure Series 9**
– Sight lines
- Figure Series 10**
– Privacy
- Figure Series 11**
– Overshadowing

Intent

The purpose of figure series 10 is to illustrate how to establish the **cone of vision** to determine overlooking, and how to measure privacy **setbacks** for the purposes of clauses 5.4.1 C1.1 and 6.4.1 C1.1.

Figure 10a – Establishing the horizontal component of cone of vision

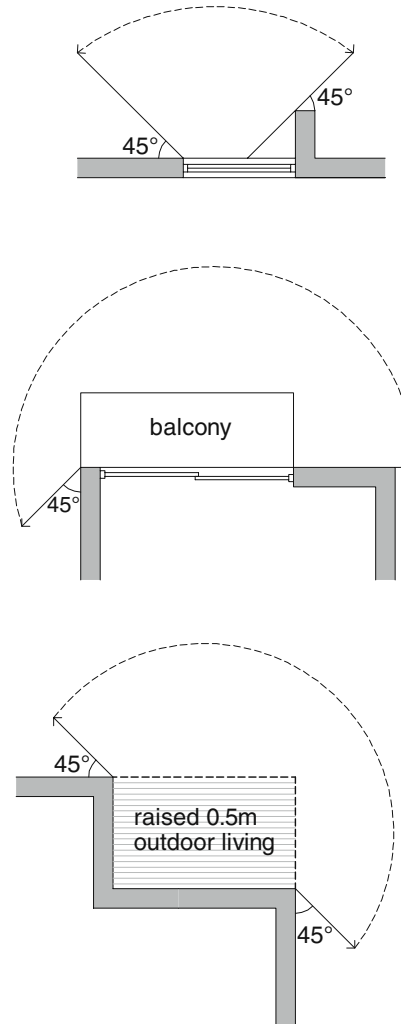

Figure 10b – Measurement of minimum privacy separation distances

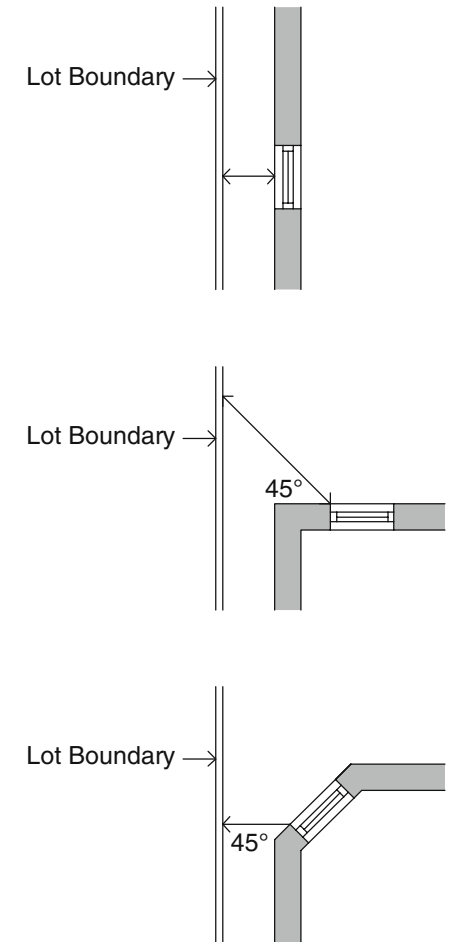
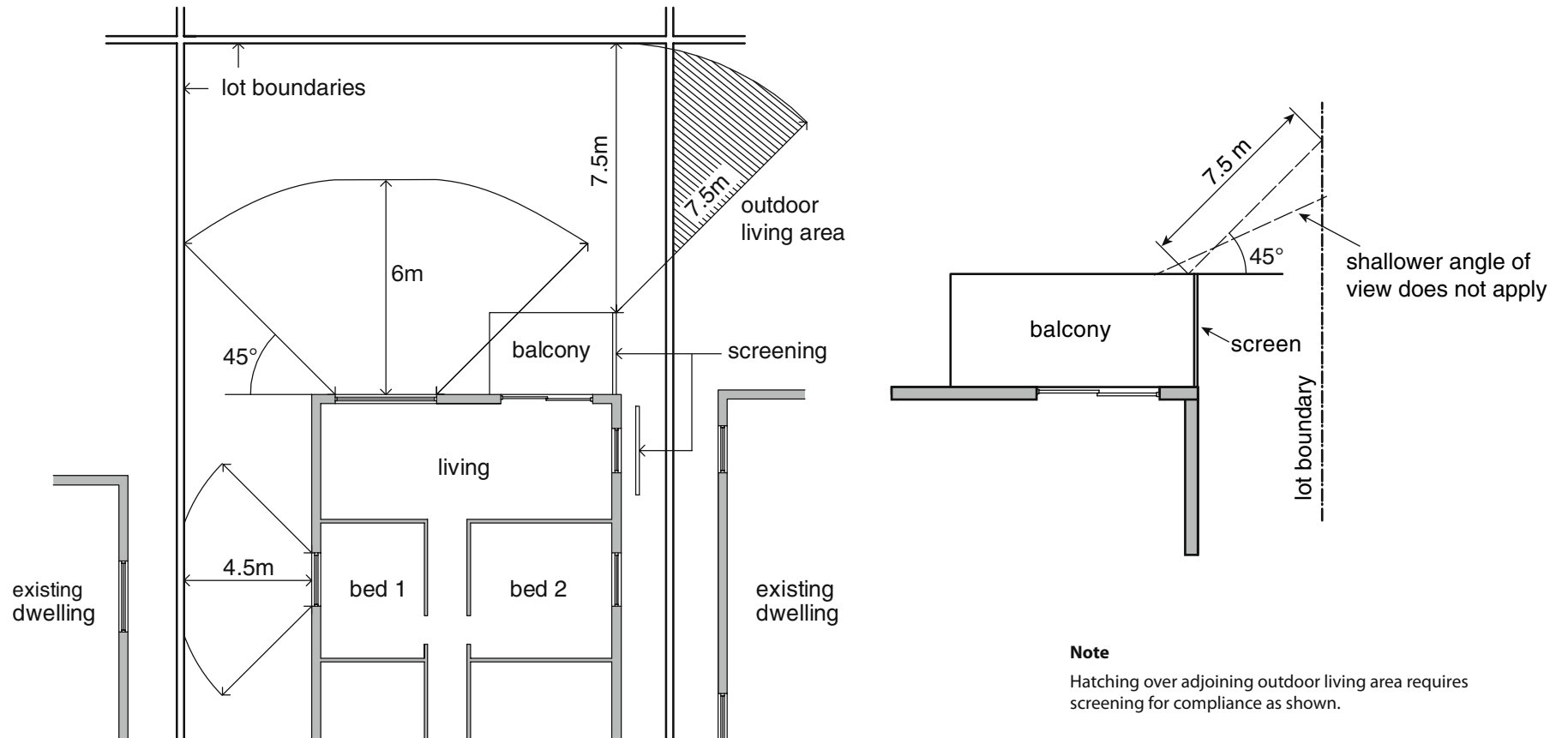

Figure Series 10 – Privacy

Figure 10c – Measuring privacy setbacks using the cone of vision



[Return to contents page](#)

- Figure Series 1**
– Site area measurement
- Figure Series 2**
– Street setbacks
- Figure Series 3**
– Wall height for lot boundary setbacks
- Figure Series 4**
– Wall length for lot boundary setbacks
- Figure Series 5**
– Lot boundary walls
- Figure Series 6**
– Open space
- Figure Series 7**
– Building height
- Figure Series 8**
– Garages and carports
- Figure Series 9**
– Sight lines
- Figure Series 10**
– Privacy
- Figure Series 11**
– Overshadowing



Figure Series 11 – Overshadowing

[Return to contents page](#)

- Figure Series 1**
– Site area measurement
- Figure Series 2**
– Street setbacks
- Figure Series 3**
– Wall height for lot boundary setbacks
- Figure Series 4**
– Wall length for lot boundary setbacks
- Figure Series 5**
– Lot boundary walls
- Figure Series 6**
– Open space
- Figure Series 7**
– Building height
- Figure Series 8**
– Garages and carports
- Figure Series 9**
– Sight lines
- Figure Series 10**
– Privacy
- Figure Series 11**
– Overshadowing

Intent

The purpose of Figure Series 11 is to illustrate the correct way of measuring overshadowing for the purposes of clauses 5.4.2 and 6.4.2.

Figure 11a – Calculation of overshadowing (clauses 5.4.2 C2.1 and 6.4.2 C2.1)

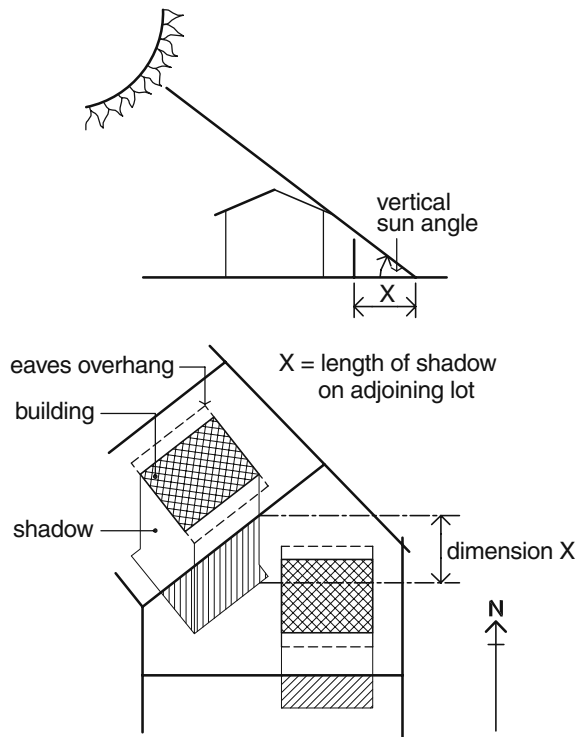
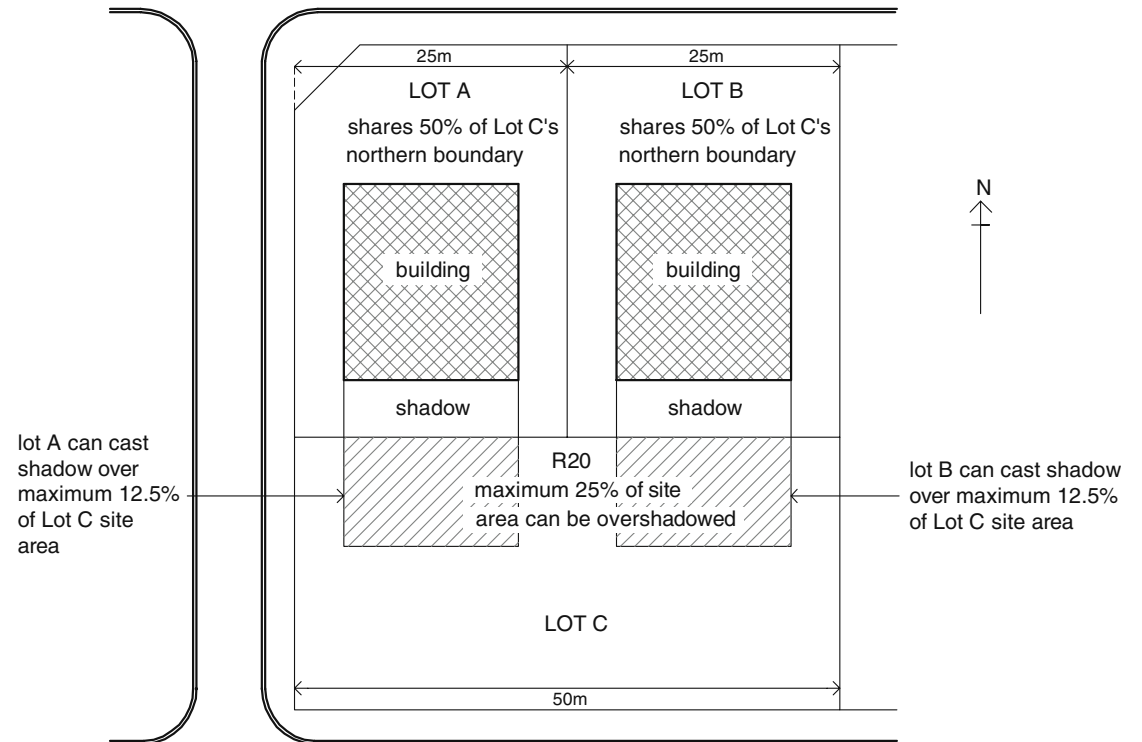

Figure 11b – Proportionate limits from shared northern boundaries (clauses 5.4.2 C2.2 and 6.4.2 C2.2)



Notes

For methodology on the calculation of overshadowing in Figure 11a, see the explanatory guidelines.

