

edition

3



MINIMUM CONSTRUCTION REQUIREMENTS FOR WATER BORES IN AUSTRALIA

February 2012

**MINIMUM CONSTRUCTION
REQUIREMENTS
FOR WATER BORES
IN AUSTRALIA**

Third edition

© National Uniform Drillers Licensing Committee 2011

First published 1997

Second edition 2003

Third edition 2012

ISBN 978-0-646-56917-8

Contacts

Specific enquiries about the material contained in this publication should be directed to the appropriate authorities listed on pages 8 and 9.

Production Assistance

Editing, design, and layout by Robee Bureau Services Pty Ltd, West Lakes, South Australia

Printed by Doran Printing Pty Ltd, Braeside, Victoria



Australian Government

National Water Commission

This project was funded by the Australian Government through the National Water Commission's Raising National Water Standards Program.

Foreword

The third edition of *Minimum Construction Requirements for Water Bores in Australia* has been developed by the National Uniform Drillers Licensing Committee.

This book outlines the minimum requirements for constructing, maintaining, rehabilitating, and decommissioning water bores in Australia. It is used extensively by regulators and the drilling industry, and provides a consistent standard reference across Australia for the licensing of bores and drillers. The requirements focus on protecting groundwater resources from contamination, deterioration, and uncontrolled flow associated with poorly constructed bores, and on the construction of bores to provide a good water supply.

The first edition was published in 1997 and it has been reviewed periodically to keep it current. This third edition is the outcome of an extensive review process. It draws on the combined experience and knowledge of the drilling industry and regulators, and incorporates submissions from both groups. The authorities listed in Section 2 can direct you to further copies and/or respond to your enquiries.

The major features of this edition are:

- the separation of the requirements into *mandatory requirements* and *good industry practice*
- the development of *principles*, which are the critical elements in constructing, maintaining, rehabilitating, and decommissioning bores, and protecting the groundwater resource of Australia
- significant updates of some technical aspects, including casing, sealing, and bore head completion
- that it is written in plain English.

Mandatory requirements are enforceable by regulators for the protection of the groundwater resource.

Good industry practice draws on the industry's experience and describes methods and techniques which, while not mandatory, are recommended to:

- help satisfy mandatory requirements
- provide efficient and cost-effective water bores
- ensure the long-term efficiency and operation of the water bore.

Earlier editions have been well received and well supported by the drilling community and regulators. On behalf of the National Uniform Drillers Licensing Committee, I recommend the third edition of *Minimum Construction Requirements for Water Bores in Australia* to you.

Virginia Hilliard

Chair

National Uniform Drillers Licensing Committee

National Uniform Drillers Licensing Committee (NUDLC)

The members of the NUDLC are listed below:

- Australian Drilling Industry Association
- Australian Drilling Industry Training Committee
- New South Wales Department of Primary Industries, Office of Water
- Department of Natural Resources, Environment, The Arts and Sport, Northern Territory
- Department of Environment and Resource Management, Queensland
- Department for Water, South Australia
- Department of Primary Industries, Parks, Water & Environment, Tasmania
- Department of Sustainability and Environment, Victoria
- Department of Water, Western Australia
- Water Corporation, Western Australia
- Drilling industry representatives and drilling contractors.

Project Team

- Mark Ballard
- Kevin Dennis
- Hemantha Desilva
- Simon Fitzgerald
- Stan Gricks
- Virginia Hilliard
- Bruce Keogh
- John McAvan
- Randal Nott
- Don Rockliff

In addition to these contributors, the NUDLC wish to acknowledge the generous financial assistance provided by the National Water Commission, and thank the many people who made detailed submissions, provided valuable feedback, and participated in review sessions across Australia as this third edition was being developed.

Contents

1. Introduction	1
Need for Minimum Bore Construction Requirements	1
Principles	3
2. Administrative Requirements and Responsibilities	7
Mandatory Requirements	7
Responsibilities	9
3. Bore Design and Common Types	13
4. Drillers' Classification System and Drilling Methods Used	23
Drillers' Classification System	23
Drilling Methods	25
Mandatory Requirement	32
Good Industry Practice	32
5. Siting a Water Supply Bore	33
Mandatory Requirement	34
Good Industry Practice	34
6. Formation Sampling and Water Sampling	37
Formation Sampling	37
Mandatory Requirement	37
Good Industry Practice	38
Water Sampling and Analysis	39
Good Industry Practice	40
7. Drilling Fluids	41
Mandatory Requirement	42
Good Industry Practice	42
8. Bore Plumbness and Straightness	45
Good Industry Practice	45
9. Casing	47
General Considerations	47
Types of Casing	48
Collapse Resistance of Pipes or Casings	51
Mandatory Requirements	52
Good Industry Practice	54

10. Maximising Bore Efficiency and Water Entry	55
Open Hole	55
Slotted and Perforated Bore Casing	56
Screens	57
Sieve Analysis	59
Gravel Packing	61
Good Industry Practice	61
11. Bore Sealing	65
Supervision of Cementing	65
Effective Sealing	65
Mandatory Requirements	70
Good Industry Practice	72
12. Bore Development	73
Use of Chemicals	74
Use of Mechanical Methods	74
Sand Content	75
Good Industry Practice	75
13. Bore Yield Testing	77
Bore Testing by Drillers	78
Good Industry Practice	80
14. Disinfecting Water Bores	81
Good Industry Practice	82
15. Recording and Reporting Data	83
Mandatory Requirement	84
Good Industry Practice	84
Rock Types	87
16. Bore Completion, Headworks, and Site Restoration	91
Headworks	91
Restoring the Drilling Site and Waste Disposal	91
Mandatory Requirements	92
Good Industry Practice	94

17. Bore Maintenance and Rehabilitation	95
Monitoring	95
Bore Maintenance	96
Rehabilitation	97
Mandatory Requirements	98
Good Industry Practice	98
18. Bore Decommissioning	101
Mandatory Requirements	105
Good Industry Practice	107
Appendixes	
A. Acronyms and Definitions	109
B. Resources	116
C. Typical Bore Types	118
Common Bore Designs	118
Decommissioned Bore	121
D. Sample Contract Documentation	122

List of Figures

Figure 3.1	Single aquifer bore	14
Figure 3.2	Multiple aquifer bore	14
Figure 3.3	Flowing aquifer bore	15
Figure 3.4	Stock and domestic (low-yielding, non-flowing) bore (incl. electric submersible pump)	16
Figure 3.5	Commercial (higher yielding, non-flowing, screened, and gravel packed) bore	18
Figure 3.6	Water monitoring bore (non-flowing)	19
Figure 10.1	Example of an open-hole bore construction	56
Figure 10.2	Examples of perforated and slotted casing	57
Figure 10.3	Stacked set of sieves used to provide a grain distribution curve	59
Figure 10.4	Example of a sieve analysis report	60
Figure 12.1	Improving bore permeability through development	73
Figure 12.2	The bore development process	74
Figure 15.1	Example of a bore completion report/drill log	86
Figure 16.1	An example of headworks design for a flowing bore	92
Figure 18.1	Decommissioning a non-flowing bore by fully grouting (preferred method for all bores)	102
Figure 18.2	Decommissioning a single aquifer non-flowing bore	103
Figure 18.3	Decommissioning a multiple aquifer non-flowing bore using cement grout bridges	104
Figure 18.4	Decommissioning a flowing bore using cement grout bridges	105
Figure C1	Monitoring bore with bentonite seal and backfill to surface	118
Figure C2	Permanent headworks for non-flowing bore with concrete pad and steel protecting pipe	118
Figure C3	Temporary headworks for non-flowing bore	118
Figure C4	Permanent headworks completion of a non-flowing monitoring bore	118

Figure C5	Gravel-packed bore with casing cemented in place and gravel pack terminated above top of the screen with gravel feed pipe	119
Figure C6	Naturally developed bore with telescopic screen, pump housing casing driven or jacked into place, and the conductor sealed	119
Figure C7	Gravel-packed bore with telescopic screen, casing cemented in place	119
Figure C8	Naturally developed bore with inline screens	119
Figure C9	Naturally developed bore with telescopic screen, temporary casing driven or jacked into place, and the pump housing casing sealed to prevent contamination	120
Figure C10	Bore with open hole completed in consolidated formation	120
Figure C11	Bore with telescopic slotted casing liner completed in consolidated formation	120
Figure C12	Gravel-packed bore completed in consolidated formation, with casing cemented in place	120
Figure C13	Slotted casing or screened bore completion in an artesian aquifer, where the piezometric level is above the ground elevation	121
Figure C14	Permanent headworks for non-flowing bore with concrete pad and steel protecting pipe	121
Figure C15	Naturally developed non-flowing bore in unconsolidated formation, where the hydraulic properties of the formations are different and need permanent separation	121
Figure C16	Decommissioned non-flowing bore	121

List of Tables

Table 4.1	Drilling methods and their applications	26
Table 4.2	Recommended (optimum) up-hole velocities (UHV) (bailing velocities)	29
Table 7.1	Suggested Marsh funnel viscosities for unconsolidated materials	42
Table 9.1	Reactivity of steel casing to corrosive waters	49
Table 9.2	Comparison of strengths of bore casing materials	51
Table 9.3	PVC-U temperature derating	51
Table 11.1a	Recommended cement–water mixes Basic mix using Portland (GP) cement	67
Table 11.1b	Recommended cement–water mixes Basic mix using Builders cement (25% Fly Ash)	67
Table 11.2a	Recommended cement–bentonite–water mixes using Portland (GP) cement	67
Table 11.2b	Recommended cement–bentonite–water mixes using Builders cement (25% Fly Ash)	68
Table 11.3	Recommended light cement mixes using microcells	69
Table 13.1	Type and duration of pumping test	77
Table 15.1	Guidelines for rock classification and description	89
Table 15.2	Guidelines for soil classification and description	89
Table 17.1	Chemicals used in the treatment of bores	97

1. Introduction

Need for Minimum Bore Construction Requirements

A high percentage of Australia's total water use is from groundwater, and this percentage is increasing as surface water resources become more heavily used.

Water bores are the most common means of tapping groundwater. The siting, design, materials, and construction method used all influence the quantity and quality of water obtained.

Purpose of this Book

The purpose of this book is to provide a technical basis for, and a description of, the minimum requirements for constructing water bores in Australia. It both complements and underpins the national drillers' licensing system by providing a bore construction standard that is consistent across Australia.

Although it is mainly for the use of the water drilling industry, this book should also be of interest to anyone intending to construct a water bore.

In prescribing the minimum acceptable construction requirements, it is not intended to be viewed as a substitute for formal training.

Drillers play a vital role in the development, use, and protection of the groundwater resource. They provide a service to clients, and thus have a responsibility to ensure that this role is fulfilled through high standards of work and the use of materials appropriate to the particular work involved.

These minimum requirements provide the technical base for licensed drillers, for bore permits, and as a reference for bore construction. This edition separates these requirements into mandatory requirements and recommendations for good industry practice.

Mandatory Requirements

Mandatory requirements are enforceable by regulators for the protection of the groundwater resource. All drilling activities shall be conducted in accordance with applicable state and/or territory regulatory requirements.

Good Industry Practice

Good industry practice describes methods and techniques recommended to:

- help satisfy mandatory requirements
- provide efficient and cost-effective water bores
- ensure the long-term efficiency and operation of the water bore.

These requirements are not designed to meet the specific needs of landholders or purchasers, or to replace the specifications that various state and territory water authorities currently use.

In the context of this book, the term 'drilling operations' encompasses:

- drilling
- bore construction
- development
- maintenance and rehabilitation
- decommissioning.

This book considers the design, materials, reporting, and recording requirements for all aspects of drilling operations. In doing so, these requirements aim to ensure the:

- protection of the groundwater resource from contamination, intermixing, and uncontrolled flow
- long-term economic production of groundwater of the best possible quality.

The finished bore is a result of a number of considerations and decisions. These include:

- the intended purpose of the bore
- geological and hydrogeological conditions, including groundwater quality
- drilling methods
- construction methods
- bore performance improvements (e.g. bore development and disinfection)
- bore performance indicators (e.g. pumping test and water quality test).

The finished bore is further affected by the inherent nature of drilling, which disrupts the native environment. Bores drilled to intersect aquifers will disturb the aquifers by providing a vertical connection between aquifers if not sealed correctly, and a connection can mix different heads or groundwater qualities.

Where drilling intersects groundwater held under pressure, uncontrolled flowing (artesian) bores can result, causing wastage of the groundwater resource and the loss of hydrostatic pressure. All non-flowing bores can potentially provide a means of contaminating groundwater by acting as a conduit for surface run-off.

Deteriorated or abandoned bores that threaten the groundwater resource should be decommissioned in such a way that the hydrogeological environment is maintained or is returned as near as possible to the condition that existed before drilling.

This book was originally prepared in 1997 and reviewed in 2003 by a steering committee comprising representatives from all state and territory governments, the Australian Drilling Industry Association, and the Australian Drilling Industry Training Committee.

It has recently been revised and reprinted following another review, which sought submissions from the drilling industry and other stakeholders.

All three editions of this book have included information from Australia and other parts of the world, drilling industry reference materials, and relevant Australian and overseas standards.

Definitions of terms used in this book are in Appendix A, and useful resources are listed in Appendix B.

Principles

Although every hole is usually slightly different, there are some critical elements that go towards constructing a water bore that will provide a good supply of water to the end-user for many years to come, without affecting the capacity or quality of nearby aquifers for other users and the community in general.

In order to ensure that such a precious resource is adequately protected, adherence to the following principles is crucial.

These principles are not exhaustive, but are included because they are known to be effective.

The principles are:

- Chapter 2*
 - The driller and owner of the bore shall adhere to all relevant state or territory legislative requirements.
- Chapter 3*
 - Bore design shall:
 - suit the hydrogeological conditions
 - be appropriate to protect the aquifer
 - be suitable for the intended purpose of the bore
 - meet the client's requirements.
- Chapter 4*
 - The bore shall be constructed by a suitably qualified driller who possesses the appropriate experience and the relevant class of licence that the state or territory deem necessary.
- Chapter 5*
 - A bore is sited to provide a reliable and useful water supply.
 - Information should be sought about the hydrogeological conditions in the area before drilling.
 - Water supply bores shall be positioned a suitable distance from known possible sources of contamination, or designed and constructed to eliminate all sources of contamination.
 - The driller shall ensure the location complies with any conditions specified in the bore permit.
- Chapter 6*
 - Formation samples shall be taken to determine the nature and type of strata, and to confirm any changes in the formation.
 - Water samples should be taken to provide a guide to water quality encountered during drilling operations.

- Any water samples taken during or immediately following construction and development should be representative of the groundwater.
- Chapter 7*
 - Drilling fluids should be selected and managed to:
 - facilitate the drilling process
 - ensure the removal of cuttings from the borehole
 - minimise damage to the formations.
 - Chemicals and other drilling fluid additives that could leave a residual toxicity should not be added to any drilling fluids or cement slurries (i.e. grouts) used to drill and complete any water bore.
- Chapter 8*
 - Bores should be sufficiently plumb and straight to ensure that there will be no interference with the installation, alignment, long-term operation, or future removal of the pump.
- Chapter 9*
 - Water bore casings and joints shall:
 - prevent the collapse of the strata penetrated
 - assist in construction and sealing, and prevent intermixing
 - be strong enough to withstand installation, construction, and operational pressures
 - provide access to the water-producing zone
 - be of sufficient size to act as a safe housing for the pump selected for the hole
 - provide an adequate operational life.
- Chapter 10*
 - The method of completion across the water entry zone of the bore should:
 - allow efficient entry of water into the bore
 - stabilise the formation
 - prevent unacceptable ingress of materials from the formation.
- Chapter 11*
 - Bores are sealed to:
 - protect the groundwater resource from contamination
 - maintain aquifer pressures and quality
 - isolate the targeted production zone from other formations.
- Chapter 12*
 - Bores are developed to:
 - remove introduced products
 - improve near well permeability
 - reduce entry losses
 - reduce entry of suspended solids
 - increase well efficiency.
- Chapter 13*
 - All water supply bores should be tested to establish their indicative yield.
- Chapter 14*
 - Drilling equipment that has been used should be disinfected to prevent the transfer of microbiological organisms (bacteria) between sites.
 - After completing drilling, the bore should be free of any introduced microbiological organisms (bacteria).
- Chapter 15*
 - Accurate information on the drilling, construction, reconditioning, and decommissioning is recorded to be available for the use of drillers, landholders, and regulators.

Chapter 16

- Headworks shall control the flow of water.
- The protruding casing should be completed so that it:
 - is protected from damage
 - prevents surface run-off or potentially contaminated fluids from entering the bore.
- After completion of the job the site should be restored as close as possible to its original condition.

Chapter 17

- Bore maintenance is intended to preserve the performance of the bore and its component parts in good repair.
- Rehabilitation is intended to repair a bore that has failed.

Chapter 18

- Failed or unwanted bores should be decommissioned to restore, as far as possible, the aquifer isolation that existed before the bore was drilled and constructed.

This page is intentionally blank.

2. Administrative Requirements and Responsibilities

Principle:

The driller and owner of the bore shall adhere to all relevant state or territory legislative requirements.

At every stage during construction, all parties should take action to minimise the risks to the environment. Considerations include:

- materials used for construction and discharged from the bore
- responsible disposal of all waste.

General legislative provisions and policies are administered by water agencies in each of the states and territories.

It is essential that the drillers, consultants, and clients become fully conversant with the requirements of the state or territory in which they intend the work to be undertaken, because the relevant legislation varies between authorities.

It should be noted that it is the individual driller who is licensed, not the drilling company.

Mandatory Requirements

- 2.1 *Only drillers licensed for the class of work proposed and endorsed for the drilling method to be used shall carry out work on a water bore unless state or territory legislation provides an exemption.*
- 2.2 *An appropriately licensed driller shall be on site at all times during bore construction activities.*
- 2.3 *The owner or legal occupier of the land on which a bore is to be constructed shall obtain the appropriate bore permit from the licensing authority in the relevant state or territory. Work shall not commence on a bore until such approval has been obtained.*
- 2.4 *The driller shall sight the bore permit before commencing any work and comply with the conditions relating to the particular bore. The bore permit will stipulate the nature of the work and the reporting requirements.*

2.5 *Where an applicant wishes to use materials or technologies not referred to in this document, the applicant must submit a proposal in writing to the relevant state or territory regulator and obtain approval before using the material or technology. In the absence of any prior written approval from the regulator, the conditions of this document or the bore permit shall be adhered to.*

Australian government agencies and drilling associations from whom further information may be obtained regarding this book or drilling requirements generally are listed below.

This list was correct at the time of publication. An up-to-date list is on the ADITC website (www.aditc.com.au).

New South Wales

NSW Department of Primary Industries, Office of Water
GPO Box 3889
Sydney NSW 2001 www.water.nsw.gov.au

Northern Territory

Department of Natural Resources, Environment, The Arts and Sport
PO Box 496
Palmerston NT 0831 www.nt.gov.au/nreta

Queensland

Department of Environment and Resource Management
PO Box 156
Mareeba Qld 4880 www.derm.qld.gov.au

South Australia

State Drilling Inspector
Department for Water
GPO Box 2834
Adelaide SA 5001 www.waterforgood.sa.gov.au

Tasmania

Manager, Water Management Branch
Department of Primary Industries, Parks, Water & Environment
GPO Box 44
Hobart Tas. 7001 www.dpipwe.tas.gov.au

Victoria

Goulburn Murray Water Corporation
PO Box 165
Tatura Vic. 3616 www.g-mwater.com.au

Grampians Wimmera Mallee Water Corporation
PO Box 481
Horsham Vic. 3402 www.gwmwater.org.au

Southern Rural Water Corporation
Box 153
Maffra Vic. 3860 www.srw.com.au

Western Australia

Department of Water
PO Box K822
Perth WA 6842 www.water.wa.gov.au

Water Corporation
PO Box 100
Leederville WA 6007 www.watercorporation.com.au

Industry

Australian Drilling Industry Association Ltd
PO Box 3020
Frankston East Vic. 3199 www.adia.com.au

Australian Drilling Industry Training Committee
PO Box 742
Lane Cove NSW 2066 www.aditc.com.au

Responsibilities

When a bore is to be constructed, both the driller and the client are responsible for various aspects of the work. It is in the interests of both parties that a written agreement or contract be entered into detailing all aspects of the work to be performed.

The following is a general guide to the responsibilities of the driller and the client. It must be emphasised that some responsibilities relate to legislative requirements, which can vary between state and territory water licensing authorities.

When in doubt the respective authority should be contacted at the address shown above.

Driller responsibilities

The driller generally has responsibility for:

- giving the client accurate and competent technical advice on the work
- providing references
- giving the client a written quotation for work to be performed and materials to be supplied
- deciding the construction method to be used
- offering a warranty on completed and tested works, including materials and the quality of work undertaken
- the standard of work, including ensuring that the quantity and quality of materials used are suitable for the job
- providing the client with regular and timely reports of progress and any other information that may be relevant to the work and its cost
- where legislation exists, ensuring that the client holds a current bore permit for the type of bore being constructed. The driller shall comply with the conditions of the bore permit
- providing the client and the state or territory water licensing authority with a written log of the details of each bore
- providing advice on the flow and quality of water on completion of a bore
- leaving the site in a clean and tidy manner and free from contamination.

See Appendix D for a sample contract.

At all times during the progress of the work the driller shall use reasonable precautions to prevent:

- tampering with the bore
- the entry of foreign material
- the entry of surface water into the bore.

NOTE: It is unwise for a driller to warrant or guarantee the quantity or quality of water before drilling is carried out.

Client responsibilities

In general, the client has the following responsibilities:

- seeking advice on the likely availability of a water supply and its quality
- obtaining the necessary bore permit to construct the bore and complying with the bore permit conditions
- arriving at a written agreement/contract with the driller on the work to be carried out and the materials to be supplied
- where legislation requires, ensuring that the driller holds a current driller's licence for the class of work and drilling method to be employed
- being readily contactable during the drilling operations

- selecting and, if necessary, preparing or clearing the site, often in consultation with the driller
- providing suitable access to the bore site(s)
- submitting reports and water samples to the relevant authority where required.

NOTE: It is unwise for a driller to warrant or guarantee the quantity or quality of water before drilling is carried out.

High concentrations of individual ions may render the water unsuitable, even if the conductivity value is within limits suggested in the relevant Australian standard. The suitability of water for continued irrigation will depend on plant species, soil type, climate, and soil leaching conditions.

Therefore it is important that the client or bore owner should be aware of any water quality restrictions imposed by the intended crop types or proposed water use.

Shared responsibilities

The type and nature of bore construction should be discussed fully between the driller and the bore owner before the work commences. The following matters should be taken into account:

- state or territory legislative requirements
- protection of the aquifer
- materials required
- the desired yield or purpose of the bore
- known geological conditions
- the desired life and future maintenance of the bore
- the cost
- the duration of the contract
- checking for the existence and location of underground services
- provision of detailed strata logs, strata samples, and water samples as specified by the relevant state or territory water licensing authority
- preferred pumping equipment and power source options.

NOTE: It is unwise for a driller to warrant or guarantee the quantity or quality of water before drilling is carried out.

Differing geological formations encountered may present difficulties that even the most experienced driller could not anticipate. In such situations the driller may need to consult the client again.

The client (or a representative) should be on site for a substantial amount of the construction period, or at least be readily contactable when absence is necessary.

Minimum Construction Requirements for Water Bores in Australia

The driller should ensure that the client is fully aware of the more critical phases of construction of the bore, including responsibility for the storage of material and removal of waste.



Flowing artesian bore (prior to site cleanup)

3. Bore Design and Common Types

Principle:

Bore design shall:

- *suit the hydrogeological conditions*
 - *be appropriate to protect the aquifer*
 - *be suitable for the intended purpose of the bore*
 - *meet the client's requirements.*
-

The siting, design, materials, and construction method used in a bore all influence the quantity and quality of water obtained and the protection of the groundwater resource. The chosen bore design is the result of a number of considerations and decisions. These include the:

- intended purpose of the bore
- geological and hydrogeological conditions, including the groundwater quality
- drilling methods and construction methods.

Bore design for aquifer protection

The bore design should take into account the protection of the groundwater resource. Bores drilled to intersect an aquifer will disturb that aquifer by providing a vertical connection between aquifers of different head or groundwater qualities.

Where drilling intersects groundwater held under pressure, uncontrolled flowing (artesian) bores can result, causing wastage of the groundwater resource and the loss of hydrostatic pressure.

The design of the typical types of water bores are discussed below, according to the protection of aquifer conditions.

All non-flowing bores can potentially provide a means of contaminating groundwater by acting as a conduit for surface run-off. Importantly, the bore design should aim to ensure the protection of the groundwater resource from surface contamination. This means that the headworks and casing are sealed so that there is no potential for flow outside the casing.

Multiple aquifer

Where multiple aquifers are encountered the key element of the bore design for aquifer protection is to ensure that waters of different aquifers do not mix, either in the bore casing or in the annulus between the casing and the borehole. Sometimes two or more aquifers may be penetrated before the selected aquifer. In these instances it is often easier to ensure there is no possible mixing of waters by grouting the annulus from the production aquifer to the surface.

Often the upper aquifer contains poor-quality water, or it may be fully committed to other users. In these cases bores are drilled through the upper aquifers to allow tapping of the better quality or underallocated lower aquifers. Any unsuitable waters are excluded from the bore during casing by slotting or screening only the selected aquifer. To protect any steel casing from possible corrosive waters, annular seals are then set above the slots, or grouting of the casing to the surface is carried out, if necessary.

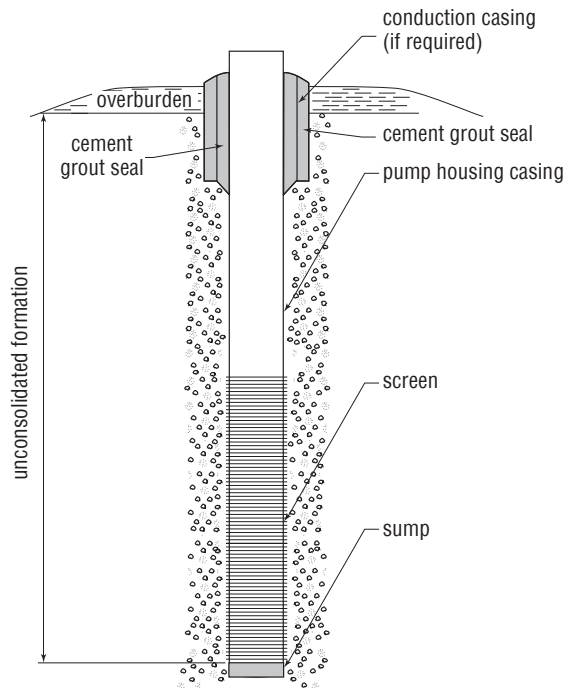

Figure 3.1 Single aquifer bore

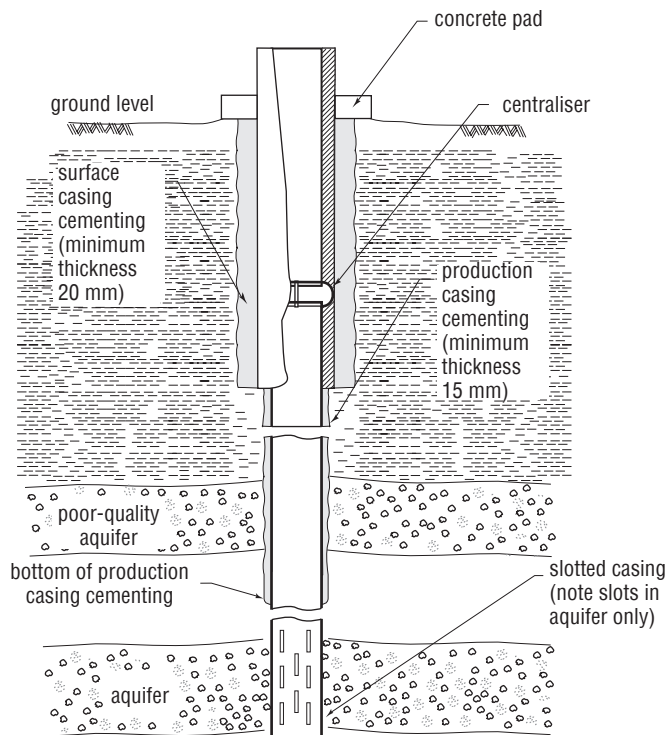

Figure 3.2 Multiple aquifer bore

Other examples of common bore designs are in Appendix C.

NOTE: Multiple aquifer bores can be completed either as flowing or non-flowing bores.

Flowing aquifer (artesian) bores

The drilling priority for artesian bore construction is the control of artesian pressure and flow. The requirements for an artesian bore include:

- protecting the production casing from corrosive soils
- preventing any discharge up the outside of the casing by the setting and cementing of surface control casing
- preventing any intermixing of waters of different quality or pressure from one aquifer to another
- tapping only one primary aquifer
- controlling formation pressures by selective cementing of the production casing.

One example of a flowing bore construction appears below. Other examples are in Appendix C.

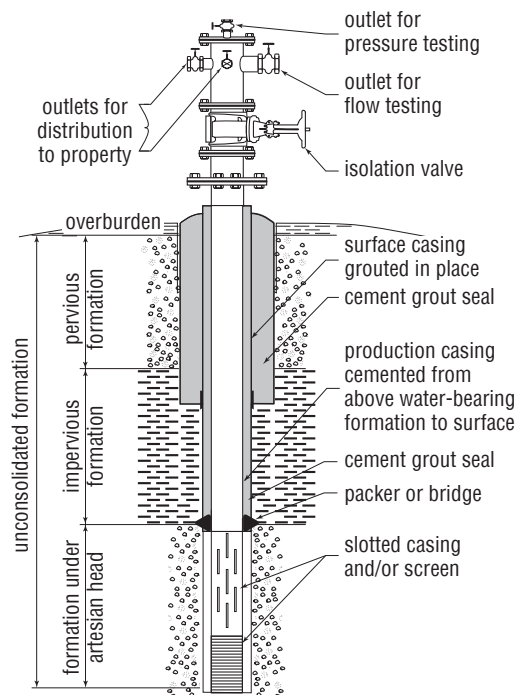

Figure 3.3 Flowing aquifer bore

During the selection process for production casing and headworks materials, consideration must be given to the depth of installation, grouting pressures, well head static pressure, and water temperature, together with the corrosive nature of the water and strata.

Bores must also be fitted with headworks of approved design to permit the control of flow, and for periodic maintenance and measurement.

These approved headworks must make provision for flow and pressure to be measured without having to disconnect or interfere with reticulation or surface pumping systems.

The construction requirements for artesian bores tapping the Great Artesian Basin (GAB) vary from state to state, and can be different from the minimum requirements described in this book. Local water licensing authorities should be consulted concerning artesian bore construction requirements before drilling in an artesian aquifer of the GAB.

In artesian aquifers outside the GAB, alternative construction requirements may be approved by the relevant state or territory water licensing authority to meet local requirements.

Common bore types

The chosen bore design is also the result of considerations and decisions relating to the intended purpose of the bore. Common bore types include:

Stock and domestic (low-yielding) water supply bores

An example of a stock and domestic (low-yielding, non-flowing) bore in a single (consolidated) aquifer formation is shown below in Figure 3.4.

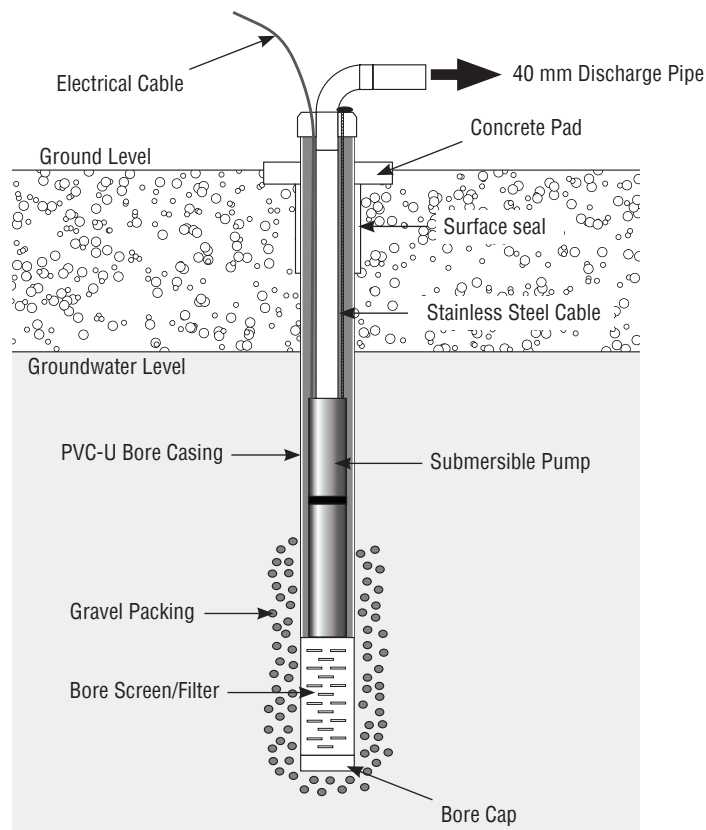

Figure 3.4 Stock and domestic (low-yielding, non-flowing) bore (incl. electric submersible pump)

Source: www.borewell.com.au/water-boring-information/diagram-of-a-bore.
Republished with permission from Borewell Pty Ltd.

Low-yielding bores are the most common type of bore.

The drilling priority is usually to obtain a usable supply of water for livestock and/or domestic use. Such bores normally use 100–150 mm diameter casing.

The basic requirements for these bores are:

- the construction technique and water entry selected to allow for the long-term production of clear silt-free water
- adequate bore straightness to allow for the installation and reliable operation of the client's preferred pump
- a usable supply of water of acceptable quality with immunity from contamination, particularly from the surface.

Commercial (higher yielding) water supply bores

Commercial bores typically include industrial, irrigation, and major water supply bores. The major objective when drilling a commercial bore is to ensure that the formation remains stable and capable of being pumped at the maximum efficient water yield. To achieve this result a test hole drilling program is usually carried out to locate the optimum production bore site.

Other important factors that must be considered include:

- selecting a casing size based on the desired or potential yield and the required pump size
- selecting a screen length appropriate to the aquifer thickness being screened
- choosing the screen slots size and gravel pack size based on analysis of the gradation of the aquifer materials
- selecting a screen diameter and length that will transmit the bore yield at low entrance velocities
- selecting a large hole diameter
- selecting gravel pack material that is well rounded and clean.

It is important in constructing a commercial bore that the long-term stability and efficiency of the operation are not compromised by imprudent cost savings.

An example of a commercial bore construction is shown in Figure 3.5.

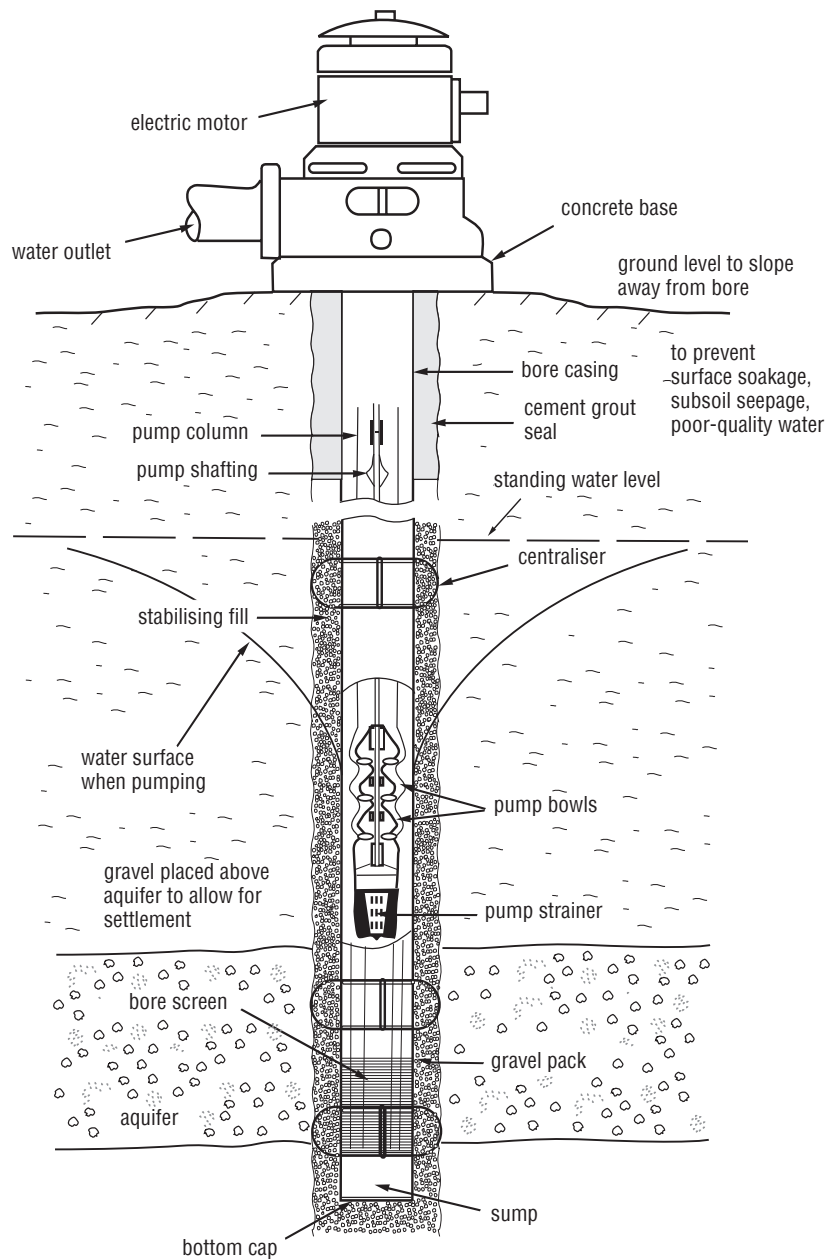

Figure 3.5 Commercial (higher yielding, non-flowing, screened, and gravel packed) bore

Groundwater monitoring bores

'Monitoring bore' has been adopted as the standard term because it is most commonly used in hydrogeological investigations throughout Australia. Other terms often substituted are 'observation well' and 'piezometer'.

Monitoring bores include bores to:

- observe water levels
- observe water quality
- intersect and monitor contaminants such as hydrocarbons, coliforms, pesticides, herbicides, and heavy metals.

Monitoring bores are drilled specifically to obtain data on groundwater. They are equipped and used for taking water samples and/or monitoring water levels. Their basic characteristic is that they are normally of low-yield construction but provide for accurate water quality sampling and water level measurements from a particular zone of interest in an aquifer.

Annulus seals and gravel packs are used where necessary to isolate the zone being monitored. Care must be taken during drilling operations and in selecting the drilling method and materials used in bore construction.

It is essential to ensure that no contaminants are introduced that may affect the monitoring or sampling results. An example of monitoring bore construction is shown below in Figure 3.6.

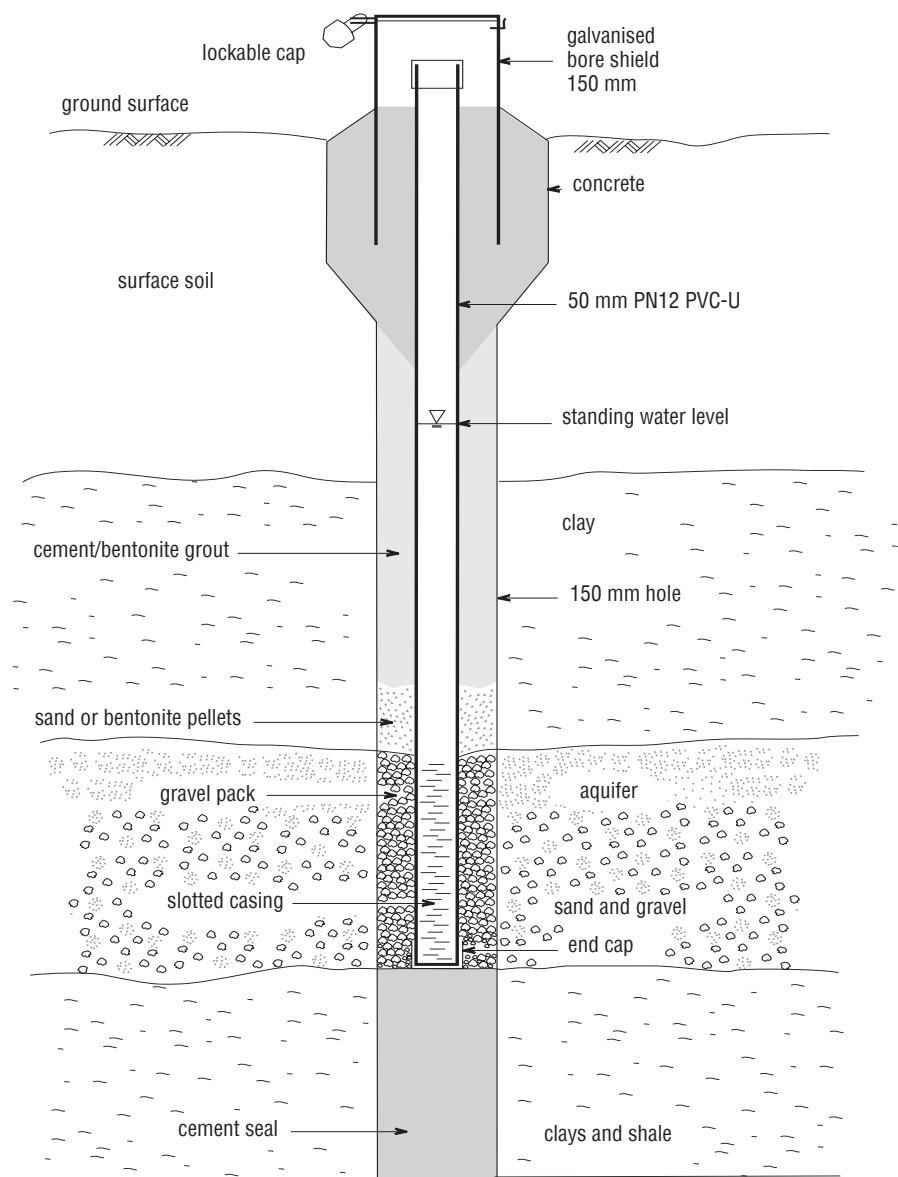

Figure 3.6 Water monitoring bore (non-flowing)

Similar requirements for sealing between aquifers are required outside the casing to prevent inter-aquifer flow.

Experience has shown that it is sometimes quicker and more secure to drill multiple holes if room permits, as any drilling time saved with a single hole can be taken up with the setting of multiple casing strings and annular cement grout seals.

Multi-port monitoring bores

Multi-port monitoring bores are specifically designed bores to obtain data from one or more aquifers or zones in a single drill hole.

Multi-port monitoring allows testing of hydraulic conductivity, monitoring of fluid pressure, and collection of fluid samples from multiple zones within a single borehole.

Construction method

A single drill hole is cased and grouted over the total depth. The bore is then perforated at the testing zones through the casing and the grout sealing. Testing ports are installed with inflatable packers insulating the perforated zone so no intermixing or contamination can occur between aquifers or zones.

Groundwater injection bores

Groundwater injection bores are used to inject water (by gravity or pressure) into an aquifer. They are commonly used in managed aquifer recharge schemes or groundwater remediation. The guidance here specifically covers injection bores for managed aquifer recharge (both storage and recovery), and aquifer storage transfer and recovery, with stormwater, recycled water, and groundwater. It does not address injection or infiltration of waters into aquifers for waste disposal.

The key issues in designing injection bores are:

- ensuring the injected water reaches only the target aquifer
- protecting the aquifer and aquitards from being damaged from over-pressurisation
- minimising problems such as clogging and excessive recovery of aquifer material.

Adequate development for the take of water

Injecting sediment-laden water into injection bores may result in the accumulation of particles outside the screen or within the gravel pack. The mixing of the injected water with the groundwater may cause mineral scaling if their water chemistries are not compatible.

Potential problems can be avoided at the design stage by:

- full cement sealing of surface and production casing to prevent upward migration of injection water via the annulus (This applies to both single and multiple aquifer systems.)
- using wire wound screens to improve yields and efficiencies

- applying appropriate screen apertures to minimise screen velocities and reduce encrustation potential
- ensuring gravel pack material is compatible with formation material and injected water.



Two views of headworks on an injection/extraction bore

Managed aquifer recharge or aquifer storage and recovery schemes can consist of either single, multi-use bores (for both injection and extraction), or multiple specific purpose bore systems where different wells are used to inject and extract water.

Construction requirements are identical to those for a multi aquifer bore (see Figure 3.2).



Submersible pump being lowered into a bore

4. Drillers' Classification System and Drilling Methods Used

Principle:

The bore shall be constructed by a suitably qualified driller who possesses the appropriate experience and the relevant class of licence that the state or territory deem necessary.

Under the national system of licensing drillers, there are three licence classes and five endorsements for drilling construction methods.

The class of licence relates to the skill level required to construct bores in different types of aquifer systems, while the endorsements relate to the drilling and construction methods that a driller is licensed to use.

Drillers' Classification System

Licence classes

Class 1 — This licence is restricted to drilling operations in non-flowing (sub-artesian) single aquifer systems.

Class 2 — This licence, in addition to operating in Class 1 conditions, permits operations in non-flowing (sub-artesian) multiple aquifer systems.

Class 3 — This licence, in addition to operating in Class 1 and Class 2 conditions, permits drilling operations in flowing (artesian) aquifer systems.

Drilling endorsements

Cable tool — permits drilling operations using cable tool or cable percussion drilling methods.

Auger — permits drilling operations using bucket auger, hollow-stem auger, and solid-stem auger techniques.

Rotary air — permits drilling operations that use rotary drilling methods with air or foam as the drilling fluid. This endorsement also includes the use of down-hole hammers.

Rotary mud — permits drilling operations that use rotary drilling methods with water as the drilling fluid or as the base for the drilling fluid.

Non-drilling rig — covers operations on water bores that do not use a drilling rig. Endorsements for non-drilling methods include:

- washed down spears using water pressure
- jetting
- hand dug holes and wells
- hand dug augers
- excavations.

NOTE: State and territory water authorities may also impose further restrictions on licence classes and endorsements.

Required skills, experience, and abilities

Class 1 Licence: The holder of a Class 1 Driller's Licence must be capable and have the knowledge and skills, as they apply to the drilling method endorsement, in:

- *the provisions of the legislation and regulations* relating to groundwater and groundwater drilling, and an understanding and appreciation of bore construction licence application procedures and licence conditions
- *siting a bore* — recognising potential contamination sources for water supply bores, and appropriately siting a bore to prevent contamination
- *straightness and plumbness of the hole* — setting up a rig, the causes of bent bores, and the methods of hole straightening
- *drilling* — correctly choosing and using equipment, having regard to such factors as rotational speed and proper annular velocities
- *fishing* — tool string inventories, fishing tools, and procedures
- *formation sampling and description* — obtaining representative formation samples, and labelling and describing them
- *bore design* — designing and constructing bores for domestic use, stock watering, groundwater monitoring, and irrigation purposes in single aquifer systems
- *construction* — seating and sealing of casing, casing types, their limitations and uses, methods of grouting casing, headworks design, and completion of the bore site
- *grouting* — grouting surface casing and decommissioning (abandoning) bores or test holes
- *setting screens and gravel packs* — selecting the appropriate slot size, screen length, and diameter, and procedures for screen installation. Selecting and installing a gravel pack
- *bore development* — basic knowledge of development techniques
- *disinfection procedures* — basic knowledge of disinfection procedures and safe chemical disposal
- *aquifer testing and water sampling* — carrying out a single stage pumping test, then determining and recording static water level, drawdown and yield, taking and labelling a water sample
- *decommissioning* — designing and selecting appropriate materials for the decommissioning of bores in single aquifer systems
- *bore completion reports* — correctly (and legibly) filling in a bore completion report.

Class 2 Licence: The holder of a Class 2 Driller's Licence must have the knowledge and skills required of a Class 1 Driller, together with the knowledge and skills, as they apply to the drilling method endorsement, in:

- *bore design* — designing and constructing bores in multiple aquifers, with emphasis on designs and methods used to exclude unsuitable waters
- *screen setting and gravel pack selection* — skill in the design of high-yielding bores is required. This entails overcoming entrance velocity problems and carrying out sand sieve analysis in order to select appropriate gravel pack material and screens (i.e. screen length, diameter, and aperture)
- *grouting* — grouting casing; placing cement plugs over selected zones; effect of cement additives; ability to calculate hole volumes, slurry volumes, and specific gravities; hole preparation; casing installation; and circulation requirements
- *aquifer testing* — the procedures involved and data required from a multi-stage pumping test
- *decommissioning* – designing and selecting appropriate materials for the decommissioning of bores in multiple aquifers.

Class 3 Licence: The holder of a Class 3 Driller's Licence must have the knowledge and skills required of a Class 1 and Class 2 Driller, together with the knowledge and skills, as they apply to the drilling method endorsement, in:

- *drilling fluids* — methods, procedures, and calculations required for formation fluid pressure control
- *grouting* — methods, procedures, and calculations required in carrying out pressure cement jobs
- *bore design* — in aquifer systems that have high pressure conditions, design of efficient bores (i.e. be able to carry out screen surface areas and diameter calculations)
- *aquifer testing* — the procedures for a flow recession test, static and staged pumping test on flowing bores
- *decommissioning* — designing and selecting appropriate materials for the decommissioning of bores having high pressure conditions.

Drilling Methods

Drilling methods range from simple digging with hand tools to high-speed drilling with sophisticated equipment. The most commonly used methods are briefly described below for the general information of readers who do not have a drilling background.

See Table 4.1 for information about drilling methods and their applications.

Table 4.1 Drilling methods and their applications

Type of formation	Cable tool drill	Auger *	Rotary air	Rotary mud	High-pressure rotary air with down-hole hammer
Sand	Suitable	Fair	Not suitable	Suitable	Not suitable
Loose sand and gravel	Difficult – fair (if casing driven)	Not suitable	Difficult – not suitable	Suitable (with fluid control)	Not suitable (see ** below)
Loose coarse gravels and boulders	Suitable (if casing driven)	Not suitable	Not suitable	Difficult – slow sometimes impossible	Not suitable (see ** below)
Loam and silt	Suitable	Fair	Fair	Suitable	Not suitable
Clays	Suitable	Fair	Suitable	Suitable	Fair
Puggy shale and mudstone	Fair	Slow	Fair	Suitable	Slow
Shale	Fair	Slow	Suitable	Suitable	Suitable
Sandstone	Fair	Slow	Suitable	Suitable	Suitable
Conglomerate	Slow	Not suitable	Suitable	Slow	Suitable
Limestone and dolomite	Slow	Not suitable	Suitable	Fair	Suitable
Limestone with small cracks or fissures	Fair – slow	Not suitable	Suitable	Fair	Suitable
Cavernous limestone	Slow	Not suitable	Suitable	Difficult	Suitable
Weathered basalts	Slow	Difficult	Suitable	Suitable	Suitable
Thick layered basalts	Not suitable	Not suitable	Slow	Slow	Suitable
Schists and Gniess	Not suitable	Not suitable	Slow	Slow	Suitable
Granite	Not suitable	Not suitable	Suitable	Suitable	Suitable

LEGEND

- Not suitable: Normally cannot drill formation type.
- Difficult: Generally not suitable but can sometimes be adapted.
- Slow: Can be used but drilling progress is usually slow.
- Fair: Suitable with some care and/or special technique suggested in brackets.
- Suitable: Normally used to drill formation type economically.

NOTES

- * Auger drilling requires high torque for rotation so depth is limited.
- ** Fair if top drive rig using hammer and swing out reamer and casing following bit.

Cable tool drilling

Cable tool drilling, otherwise known as percussion drilling, is probably the oldest drilling method. Basically it involves lifting and dropping a string of solid steel drilling tools suspended from a wire rope to hit the bottom of the hole. This process drives the cutting bit, fracturing or pulverising the formation.

The crushed material forms a slurry on mixing with water that has been added to, or is naturally present in, the hole. The blow rate varies from 40–60 strokes per minute and, because of the characteristic left lay of the wire rope cable, the bit turns and strikes across a different section of the hole bottom at each blow.

When the bit can no longer fall freely through the water–cuttings mix, the drill tools are withdrawn from the hole. A tubular bailer, which is run on a separate smaller wire rope, is then used to pick up the slurry and cuttings and remove them from the hole before drilling is resumed.



Cable tool drilling

In cable tool or percussion drilling there are basically three major operations:

- drilling the hole by chiselling or crushing the rock, clay, or other material by the impact of the drill bit
- removing the cuttings with a bailer as cuttings accumulate in the hole
- driving or forcing the bore casing down into the hole as the drilling proceeds.

Because of the relatively low initial cost and simplicity of equipment used, the cost per unit drilled is relatively low. However, the technique is slow, and when the increased cost of labour is taken into account, there is usually little advantage over faster rotary drilling methods when drilling new bores.

Cable tool drill plants are used extensively for reconditioning because they:

- are usually lighter than a rotary plant with an equivalent depth capacity
- are easier to establish over a borehole
- can also lower and retrieve tools to probe a bore more quickly than with a rotary plant
- are able to work inside casings
- are able to insert casing liners more quickly because of their better access around casing strings for screwing or welding a joint.

Auger drilling

Auger drills are used mainly for soil investigation and for drilling in soils and very soft rock. The mechanical clearing of the hole eliminates any need for pumps or compressors. Types of augers include:

- Continuous-flight augers, which can be driven by any top-drive rotary machine provided it has adequate torque rating and slow rotation. When using continuous-flight augers in deep, small-diameter holes, the cuttings are supported by the hole and carried to the surface by rotation of the helical flights.
- Hollow augers, which consist of a continuous-flight auger that has a hollow centre tube. They are normally used with a bit plug held in place by a secondary internal rod string, with the augers used to drill as with a conventional continuous-flight auger to the required depth. At that point the central bit plug and rod string are withdrawn, which permits the casing to be installed before the auger flights are removed.
- Short-flight and plate augers, which are loaded with cuttings and then pulled out of the hole. At the surface the cuttings are 'spun' off the auger.
- Bucket augers, where the cuttings are picked up in a bucket, hoisted to the surface, and dumped through the hinged bottom of the bucket. Extensions are added as the hole gets deeper.

Short-flight, plate, and bucket augers are used for shallow, large-diameter holes.

Rotary drilling techniques

The principle common to all rotary techniques is that a drill bit is attached to the end of a hollow drill pipe and rotated against the bottom of the hole with either a fracturing, digging, or scraping action, depending on the bit type and the nature of the formation.

Rotary drilling techniques are compared in Table 4.1.

Rotary air drilling

The rotary air method is used to drill holes in consolidated or semi-hard formations such as sandstone or shales that are self-supporting.

The cuttings that this process produces are cleared by circulating air, which is derived from a compressor and fed down the drill pipe to emerge through a bit. The recommended up-hole annular velocity must be maintained to remove cuttings effectively (see Table 4.2 below).

Compressor output, hole diameter, and drill pipe size should be matched to provide the required velocities.

Table 4.2 Recommended (optimum) up-hole velocities (UHV) (bailing velocities)

Fluid type	UHV (m/sec)	UHV (m/min)	UHV (fpm)
Air or mist	15–25	900–1500	3000–5000
Water	0.6	36	120
Mud	0.4	24	80
Thick mud	0.3	18	60
Foam	0.2	12	40

Source: *Guide to the National Driller Licensing Examinations* (p. 35)
© Commonwealth of Australia 2009 under licence to ADITC Ltd



Rotary air drilling

Holes can be drilled using a large volume of air at high pressure. However, the equipment usually used is limited in depth once below water level.

A major advantage of the rotary air drilling method is that water is blown to the surface as soon as the water-bearing stratum is encountered. This allows the driller to obtain a progressive indication of the available supply and to monitor any changes in the quality and quantity of water as the drilling progresses.

Air is used principally in consolidated formations. Foaming additives are occasionally used to increase the up-hole carrying capacity of the return air.

Down-hole hammer method

The down-hole hammer method involves a pneumatically operated drill bit that efficiently combines the percussion action of cable tool drilling with the turning action of rotary drilling.

A pneumatic drill bit can be used on a standard rotary rig with a high-pressure air compressor of sufficient capacity. It is used for fast and economical drilling of medium to extremely hard formations. Fast penetration results from the blows transmitted directly to the bit by the air piston. Continuous hole cleaning exposes new formation to the bit and practically no energy is wasted in re-drilling old cuttings.

Down-hole hammer drilling is generally the fastest method of penetrating hard rock. Foaming additives are occasionally used to increase the up-hole carrying capacity of the return air. Down-hole hammers are used for hard rock drilling and enable water bores to be established from fractured hard rock aquifers.

This method is not effective for drilling loose, unconsolidated materials.

Reverse circulation drilling — air (dual tube rotary air and down-hole hammer)

For this drilling method, air is introduced through a dual swivel head on a top drive rotary rig and pumped down the annulus in the dual drill pipe to the bit or hammer being used. Cuttings are returned to the surface through the inner tube.

This method is commonly used for mineral sampling to obtain an uncontaminated strata sample. It is not a common method for water bores; however, it is sometimes used for water sampling programs.

Large-diameter dual tube rotary air drill strings permit the insertion of up to 50 mm PVC-U casing through the inner tube for the construction of monitoring bores.

Rotary mud drilling

Rotary mud drilling uses drilling mud (mixes of water, bentonite clays, polymers, and additives) as the circulation medium. In the rotary mud system, drilling fluid or mud is pumped down through the drill pipe and out through nozzles in the bit.

As the bit penetrates the formation material, the drilling fluid circulates continuously and removes the cuttings. The fluid also serves to cool and lubricate the bit. The mud fluid then flows upwards in the annular space around the drill pipe to the surface, carrying the cuttings with it in suspension.



Rotary mud drilling

Photo courtesy of Connector Drilling Pty Ltd.

At the surface, the drilling fluid is conditioned before being recirculated down the hole. Properly conditioning the mud helps to prevent down-hole problems.

The basic fluid normally used for rotary drilling is water, to which specific chemicals and other additives can be added to increase the density or viscosity to improve hole support. The fluid can also be weighted to control artesian pressures.

The mud forms a membrane that inhibits flow through the walls of the hole, and the internal pressure of the mud provides structural support to the hole wall. Drilling fluids are also used for drilling deep bores that are beyond the capacity of air compressors.

The technique is useful for drilling operations in soft, unconsolidated formations, deep bores, and pressure bores.

Reverse circulation drilling — mud

In the reverse circulation drilling method, instead of circulating the drilling fluid through and up the outside of the pipe, the process is reversed. Fluid is fed down through the space between the wall of the hole and the drill pipe where it is then pumped up, together with the cuttings, through the hollow part of the pipe and then out through a discharge pipe.

Of particular importance is the possible use of a light (nearly clear) drilling fluid for large diameter holes, rather than a viscous and heavy drilling mud (as used in conventional rotary mud drilling), which sometimes tends to seal-off water-bearing formations. However, a substantial quantity of fluid must be present to maintain an open hole.

This method is used for rapid drilling of large-diameter holes in soft formations where gravels are encountered.

It is possible to bring gravel to the surface through the hollow drill pipe because of the extremely high velocity of the fluid as it is drawn up by the suction pump. The walls of the hole are held in place by the pressure of the fluid against the sides of the hole.

Sonic drilling

Sonic drilling is a relatively new technique, where a high-frequency vibration is combined with rotation to advance the drill stem. The core barrel is retrieved and the sample vibrated into a plastic sleeve or core trays. This technique is relatively continuous and undisturbed geological samples are obtained without the use of drilling fluids or other potential contaminants.

This technique is best suited to drilling unconsolidated formations, but its depth capability is somewhat limited by current technology.

Choice of Drilling Method

Each of the common drilling methods has its advantages and disadvantages (see Table 4.1 for guidance). The choice of drilling method should be based on the expected geological conditions and the type of bore to be constructed.

Mandatory Requirement

- 4.1 *Only drillers licensed for the class of work proposed and endorsed for the drilling method to be used shall carry out work on a water bore unless state or territory legislation provides an exemption.*

Good Industry Practice

- 4.2 *Drillers should use drilling methods and techniques suited to the expected hydrogeological conditions.*
- 4.3 *Drillers should not contract for or attempt works that could be reasonably expected to exceed the capabilities and limitations of the drill plant to be used.*
- 4.4 *Drillers should maintain the optimal up-hole velocity throughout the drilling of the bore (see Table 4.2).*

5. Siting a Water Supply Bore

Principles:

A bore is sited to provide a reliable and useful water supply. Information should be sought about the hydrogeological conditions in the area before drilling.

Water supply bores shall be positioned a suitable distance from known possible sources of contamination, or designed and constructed to eliminate all sources of contamination.

The driller shall ensure the location complies with any conditions specified in the bore permit.

Siting a water supply bore usually involves considering a range of factors in order to provide a cost-effective and reliable supply of water of acceptable quality.

Obtaining Information

Selecting and investigating the initial location are very important in the overall construction and performance of a bore. The depth, cost, and relative importance of a water supply bore will usually dictate the amount of investigation required.

Licensing authorities and hydrogeological consultants can provide information and advice, and, if required, give an assessment of groundwater availability in a specific area of interest. This could include data that is available from previous drilling work in an area (e.g. location, depth to water, amount of water pumped, type of water-bearing formation, and water quality) and other geological and geophysical records. Depending on the extent of the work required to provide the assessment, costs may be incurred. Local information may also be available from other drillers and from neighbouring landholders.

Driller Considerations

Drillers who have worked consistently in an area may have some knowledge of the construction, depth, quality, and yield of bores in that area.

The driller should have an understanding of the known hydrogeological conditions of the area to determine whether the drilling equipment available can do the job.

Provisions relating to licensing can vary between different state and territory water authorities, so drillers must check the requirements of the particular area in which they operate.

See Chapter 2 for contact details (including website addresses) for state and territory water authorities.

Client Considerations

The client should seek information from the relevant state or territory water authority so that the best site for the bore can be determined.

The client should check with the service providers (e.g. ‘Dial before you dig’) to ensure there are no underground or overhead services in the area of the proposed drill site.

The positioning of a water supply bore should be based on the best prospects for obtaining a successful supply and for working convenience.

Other requirements may have to be considered if the pump is to be solar- or wind-powered. A cleared area might be preferable if such pumps are to be used. State and local government requirements might limit or control the ways in which vegetation or timber can be cleared, and these should be checked before undertaking any clearing for a bore site.

The water supply bore site should allow ready access for heavy machinery for drilling and subsequent servicing of the bore and pumping equipment.

Some state and territory water licensing authorities may have a bore permit condition that stipulates a bore should be located not less than a specified distance from the property boundary and/or from a bore on a neighbouring property, channel or stream, or source of pollution. These pollution sources can include dairies, septic tanks and absorption trenches, refuse dumps, landfill, effluent discharges (e.g. from piggeries or feedlots, sewage treatment discharges, drainage ditches, cattle/stock dips, chemical spray use and/or preparation areas). This requirement is to minimise the possibility of contaminating the bore and any surrounding bores.

If the driller has any doubts about the potential problems and requirements for a particular situation, advice should be sought from the relevant state, territory, or local water licensing authority.

The client should provide access to the bore site and advise the driller if there are any particular site access requirements.

Mandatory Requirement

5.1 The driller shall obtain confirmation from the permit holder that the bore location meets the requirements specified in the bore permit.

Good Industry Practice

5.2 All water supply bores should be positioned away from the influence of possible sources of contamination.

- 5.3 *In bores where the target aquifer is deeper than the source of the contamination, the bore may be constructed providing the contaminated formation is adequately cased and cement sealed.*

If the driller has any doubts concerning the potential problems and the requirements for a particular situation, advice should be sought from the client and the relevant state or territory water authority.

See Chapter 16 for more information about headworks design.

- 5.4 *Bores should be positioned so that the headworks can be protected from damage, frequent flooding, and surface water drainage.*

- 5.5 *Site work should be planned and carried out in such a manner to minimise damage to property, infrastructure, crops, land, drainage works, and roads.*

- 5.6 *Before commencing drilling, the client/driller should contact the local service providers (e.g. gas, electricity, power, communications, water) to obtain advice on location of these services and the minimum clearance distances between the drilling rig and services. This information should be sought, as far as practical, in written form.*

The driller should ensure that no underground or overhead services are located in the area of the proposed bore sites.

This page is intentionally blank.

6. Formation Sampling and Water Sampling

Formation Sampling

Principle:

Formation samples shall be taken to determine the nature and type of strata, and to confirm any changes in the formation.

Formation samples are taken to produce a comprehensive and representative picture of the well, and to accurately confirm any changes in the formations. The driller shall record this information in the bore completion report.

To establish the optimum design for various elements of a final production bore, it is necessary to have reliable information on specific geological materials and aquifer conditions at a site.

Geophysical logging equipment can also be used and is recommended to confirm drilling depths and formation intervals. It can also provide information on the porosity of formation, clay content, hole diameter, integrity of the borehole, and best production zones within the aquifer sequence.

Information gained from good formation sampling influences the:

- casing size and length
- selection of casing and screen material
- aperture of the bore screen, and the gradation of the gravel pack
- construction method and cost.

Careful sampling of the water-bearing formation must be carried out during drilling in order to determine the appropriate construction procedure, screen aperture, or gravel pack size. It should be noted that any loss of fines to hole fluids can affect the accuracy of the sample test results.

Mandatory Requirement

- 6.1 *Representative formation samples shall be taken to determine the nature and type of strata encountered.*

See Chapter 15 for more information.

Good Industry Practice

6.2 So that both the driller and the client can see the formation changes, a reliable drilling log shall be completed.

6.3 Samples should be:

- collected as soon as possible after being withdrawn from the hole
- drained of excess moisture
- laid out in a regular pattern
- kept in plastic bags, or other containers of at least 500 g capacity.

Containers should be plainly marked with the bore number and depth interval relating to that particular sample.

6.4 It is recommended that samples, whether required for collection or not, should be taken at 1-metre intervals and at each change in the formation. The depth shall be recorded in each instance.



Laying out samples of drill cuttings

Guidelines for rock and soil classifications and descriptions are shown in Tables 15.1 and 15.2.

Water Sampling and Analysis

Principle:

Water samples should be taken to provide a guide to water quality encountered during drilling operations.

Any water samples taken during or immediately following construction and development should be representative of the groundwater.

It is highly desirable to know and record the quality of water encountered during construction and development. Although it may not always be possible to collect samples during the construction phase, water quality sampling should at least be undertaken during development.

Determining formation water quality will assist the client to make decisions regarding water suitability, which may impact on the:

- construction requirements
- continued construction
- selection of materials (e.g. in corrosive waters)
- modifications in construction (e.g. screen setting)
- aquifer separation requirements
- suitability of the bore for the desired purpose or in the planned operation of the completed bore.

Representative water samples will provide a clear indication of the formation water quality. Generally the costs associated with obtaining a representative sample are insignificant in the overall cost of the bore construction.

To determine the suitability of a sample to be 'representative' of the formation in question, and to provide early 'in the field' advice to the client or bore owner on the likely quality of the formation water, an approximate indication of water quality may be obtained using portable water quality monitoring equipment.

The most suitable field method for determining the total salts of the formation water in question is to use a portable conductivity meter. Conductivity can be used as a guide to total salinity, but it does not indicate the concentration of individual ions, which is ultimately required to assess the suitability of water for a particular use, nor does it indicate the presence of possible contaminants. A driller's basic portable water quality monitoring equipment should therefore include at least a conductivity meter. Other indicative field testing including pH and temperature can be carried out to provide the client with additional information on which to base decisions.

State and territory water authorities can supply a range of informative publications on water quality and suitability.

Good Industry Practice

- 6.5 *It is the driller's responsibility:*
- *to take care to ensure that the water sample is representative of the water body and is not contaminated by bore construction materials or the sampling procedure.*
 - *if possible during the drilling process to regularly report on the water quality of the formation(s) intersected.*
 - *to ensure that portable water quality monitoring equipment if provided and used is regularly calibrated, in good working order, and operated according to the manufacturer's procedures and instructions.*
- 6.6 *It is the client's responsibility to:*
- *determine types of analysis required.*
 - *understand the sampling and analytical requirements and advise if specialist sampling procedures are required.*
 - *arrange for the collection of water samples to carry out the appropriate chemical and biological analysis required to ensure that the water is suitable for the proposed purpose. (This type of testing should be carried out by a certified laboratory.)*
- 6.7 *General responsibilities*
- *A clean container, rinsed with the water to be sampled, should be used unless there are specific requirements.*
 - *Sample containers should be clearly labelled with the name and address of the licensee, bore permit number, depth to water-bearing formation, and the date the sample was taken.*
 - *A sample of water separate from the client's sampling requirements may be required by the relevant state or territory water licensing authority for analysis.*

7. Drilling Fluids

Principles:

Drilling fluids should be selected and managed to:

- facilitate the drilling process*
- ensure the removal of cuttings from the borehole*
- minimise damage to the formations.*

Chemicals and other drilling fluid additives that could leave a residual toxicity should not be added to any drilling fluids or cement slurries (i.e. grouts) used to drill and complete any water bore.

See Chapter 10 for more information about water entry.

See Chapter 11 for more information about bore sealing.

Drilling fluids are used to facilitate the removal of formation cuttings, to act as a lubricant, and to stabilise the hole during drilling operations. Inappropriate fluid control may cause washouts in the borehole and clogging of the water production zone. It can also affect the sealing process, leading to a poor grout seal between the bore wall and the casing, creating problems during borehole development.

In water-based drilling fluids the density (or weight) of a drilling fluid should be kept as low as possible to prevent loss of drilling fluid and overpressurising the formation. Dense mixes should be used only to control formation overpressure, collapse, or artesian flow.

Drilling mud viscosity should be regularly monitored and kept as thin as practicable while ensuring that the mud retains the ability to stabilise the formation and adequately clean the hole.

The equipment for testing drilling fluid includes:

- mud balance for weight fluid density
- Marsh funnel for viscosity
- filter press for filtration and wall cake
- sand content set for sand content.

The following types of drilling fluids should be considered acceptable for water bore drilling:

- water-based drilling fluids
- air-based drilling fluids.

Many products are available to enhance the performance of the drilling fluid, and they should be used in accordance with the manufacturer's recommendations.

Additives are used to assist the:

- lubrication and cooling of the drill bit
- suspension capability and removal of cuttings
- hole stability and filtration control
- control of subsurface pressures.

Mandatory Requirement

- 7.1 *Chemicals or other substances that could leave a residual toxicity shall not be added to the drilling fluid.*

Good Industry Practice

- 7.2 *Fresh non-polluted water (or if this is not possible the best quality water that is reasonably available) should be used as the base fluid (i.e. make-up water) for all water bore drilling fluid preparations.*
The conductivity and pH values of all make-up waters should be measured and recorded.
- 7.3 *The use of drilling fluid additives should be in accordance with the manufacturer’s recommendations.*
- 7.4 *Material Safety Data Sheets (MSDS) and manufacturer’s recommendations should be available on the drill site for all drilling fluid products used.*
- 7.5 *Drilling fluid properties should be tested regularly as a normal part of the drilling program, or as determined by the drilling conditions.*
- 7.6 *To maintain the cleanliness of the hole, drilling fluid circulation viscosity should be as shown in Table 7.1.*

Table 7.1 Suggested Marsh funnel viscosities for unconsolidated materials

Material drilled	Marsh funnel viscosity (seconds)
Fine sand	30–45
Medium sand	40–55
Coarse sand	50–65
Gravel	60–75
Coarse gravel	75–85
Lost circulation	85–120

Because viscosity can often be confused with density, the specific gravity or density should be determined by means of a mud balance and not just estimated.



Measuring viscosity using a Marsh funnel

Photo courtesy of ADITC Ltd.

The use of chlorides as a hydration (clay) inhibitor and weighting agent is not recommended where steel casing is used.

- 7.7 *The drilling fluid should be removed from the hole to allow the subsequent development of the bore.*

This page is intentionally blank.

8. Bore Plumbness and Straightness

Principle:

Bores should be sufficiently plumb and straight to ensure that there will be no interference with the installation, alignment, long-term operation, or future removal of the pump.

Boreholes should be drilled and casings set to retain roundness and also be constructed straight and as close to vertical as possible.

Plumbness and straightness are never perfect. However, the driller should be expected to keep straight and plumb within practical limits under most conditions by exercising reasonable care and using equipment that is adequate and appropriate for the job.

Plumbness and straightness become more critical with deeper holes and where a shaft-driven turbine pump, helical screw type or rod-driven pump (such as a windmill or pumpjack) is to be installed in the bore.

A bore that is not straight can cause wear on the pump rods or pump shaft, shaft bearings, and discharge column. Under extreme conditions it may be difficult to insert a pump into, or withdraw it from, a bore.

Good Industry Practice

8.1 *A stabiliser with the same diameter as, or larger than, the casing should be included in the drill string directly above the bit to keep the hole as straight as possible.*

This should allow sufficient clearance to enable the insertion of the casing string.

8.2 *A basic plumbness and alignment standard is that the completed bore is sufficiently plumb and straight when there is no interference with the installation, alignment, operation, or future removal of the pump.*

The standard for acceptance could be that the pump is successfully installed with sufficient clearance, and does not touch the casing at any time during installation.

Good quality control by the driller should include a periodic check of the plumbness of the cable or drill string suspended in the borehole.

Before running casing in deep holes a drift-direction survey (i.e. using a deviation tool) can be run to see the direction that the hole is heading and to allow an estimate of how the casing will run.



Centering the casing

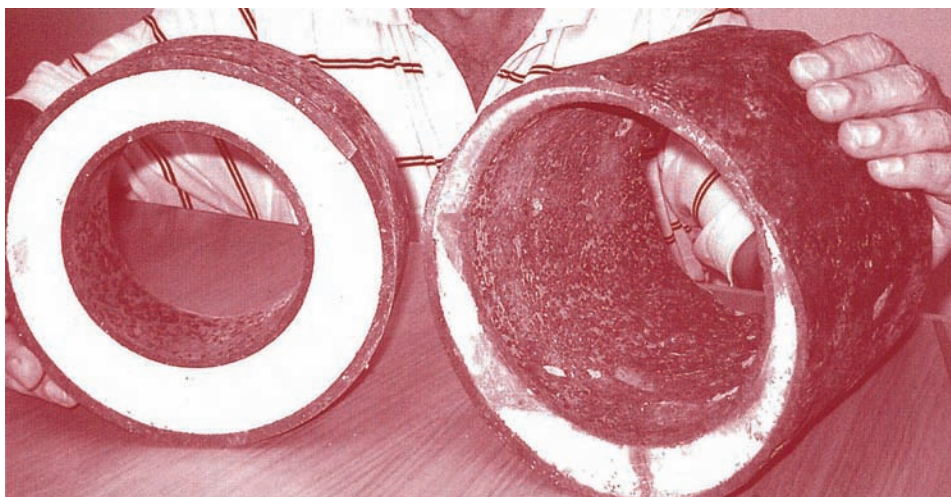

Casing centred in the bore hole — correctly and incorrectly

9. Casing

Principle:

Water bore casings and joints shall:

- *prevent the collapse of the strata penetrated*
 - *assist in construction and sealing, and prevent intermixing*
 - *be strong enough to withstand installation, construction, and operational pressures*
 - *provide access to the water-producing zone*
 - *be of sufficient size to act as a safe housing for the pump selected for the hole*
 - *provide an adequate operational life.*
-

General Considerations

The casing provides the conduit from the water-producing zone to the surface. It is also important in assisting in the construction of the bore, and must be of sufficient strength and composition to withstand the pressure exerted by the surrounding strata and other forces imposed during installation, bore development, and any cementing operations.

It should provide a secure and leakproof conduit from the water source to the surface through unstable formations and through zones of actual or potential contamination.

Casing joints should be watertight and have the same structural integrity as the casing itself.

The selected casing material and overall diameter of the bore casing should be adequate to accommodate the size of pump that has been selected. It should take into account:

- the efficiency of the pumping unit
- the expected pump life
- the extra clearance required in the event that the casing is not perfectly straight
- the possibility of welds and other fasteners projecting inside the joints of the casing
- the possibility of weld intrusions on steel casing
- any potential corrosion issues.

A range of casing materials are available, and casing selection depends on several major factors. These include:

- strength requirements
- corrosion resistance
- ease of handling
- cost considerations
- type of formation
- the particular bore design

- the method of drilling
- construction techniques
- bore permit requirements.

Where resistance to collapse is the most critical strength requirement for boreholes with unstable formations, steel or FRP casing is usually selected to meet the strength characteristics required.

For corrosive water, PVC-U, ABS, FRP, or stainless steel casing provides the longest life possible. Because of the many and sometimes conflicting factors involved in selecting the most suitable casing material, the driller should consult with the manufacturer/supplier and bore owner before selecting the casing.

Types of Casing

The main types of casing used in bores are:

- steel
- PVC-U
- ABS
- FRP and FRE
- stainless steel.

Each of these has different properties in relation to column, collapse and tensile strengths, resistance to corrosion, reaction to ground and water chemistry, and temperature.

Steel

Steel is a commonly used casing material because of its greater strength. When used as a casing it can be butt welded or screwed. Steel has the following advantages over other types of materials.

- It is stronger than other materials.
- It can be pressure-cemented to greater depths because of its higher collapse strength.
- It can withstand high temperatures.
- It is available in large diameters.
- It can withstand rougher treatment.

A disadvantage of steel is that its life can be reduced in a corrosive environment. This can be through corrosive soils, water, or by galvanic action arising from the use of dissimilar materials in the bore.

Some potable waters can be very corrosive to steel because of the dissolved gases they contain. Carbon dioxide (CO₂) is the most common of these gases. Groundwater with high levels of dissolved CO₂ and oxygen (O₂) can accelerate the corrosion of steel (see Table 9.1).

The reactivity shown in the table can vary, depending on the chemistry of the particular water.

Table 9.1 Reactivity of steel casing to corrosive waters

Reactive agent	Water quality	Reaction
pH	less than 5.5	corrosive
O ₂	more than 4 mg/L	corrosive
CO ₂	more than 100 mg/L	corrosive
CO ₂	50–100 mg/L	marginal/corrosive
CO ₂	less than 50 mg/L	acceptable

Non-ferrous or plastic materials are commonly used as casing materials where corrosive waters preclude the use of steel.

PVC-U (Unplasticised polyvinyl chloride)

PVC-U piping is made for a wide range of uses including drainage and general water distribution. It is made in a variety of wall thicknesses and internal diameters.

The only PVC-U piping suitable for use as bore casing is pressure-rated pipe manufactured to conform to AS 1477. This Australian standard is for pipe that is rated for potable water supply.

Because of recent changes in AS 1477, PVC-U pipe now uses a pressure nominal (PN) rating instead of a class. PN indicates the pressure rating of the PVC-U, which provides a guide to the external collapse pressure.

The collapse pressure of PN 6 pressure pipe has been found to have insufficient strength and shall not be used as bore casing. PN 9 piping can be used with care for shallow bores. PN 12 piping is the recommended casing for most bore construction applications.

PVC-U has the following advantages over other types of materials. It is:

- non-corrosive.
- readily available in some sizes, particularly small diameters.
- light and easy to handle and join.
- inert.

PVC-U casing is low in compressive strength relative to steel casing. The actual strength for any situation will depend on the uniformity of the wall thickness, the roundness of the casing, the rate of loading, and the temperature of the casing when the loading is applied.

PVC-U material is much more flexible than steel, and temperatures greater than 20°C reduce the pressure rating of the casing. It should be de-rated in accordance with the manufacturer's specifications when used with elevated water temperatures and when cementing.

The following factors should also be considered.

- PVC-U casing requires care in handling, storage, and installation to prevent breakage and/or distorting its shape.
- Plastic parts installed above the ground must be protected from damage (e.g. from moving vehicles, contact with drilling tools, fire).
- The impact strength of PVC-U casing may be reduced significantly over time from extended exposure to UV rays.
- Occasionally PVC-U casing will float in a bore during installation, thus creating special handling problems.
- The short-term strength of PVC-U casing is much higher than its strength over time. Therefore the driller should consider the long-term forces of the formation on the casing.
- Changes to differential pressure and temperature ratings may result from cementing.
- If volatile organic chemicals make contact with PVC-U casing, they may permeate the casing and enter the bore.
- It should be centred in the borehole during backfilling or gravel packing. Any voids in the backfill or gravel pack may lead to a sudden collapse of formation materials against the casing, causing the casing to collapse.

ABS (Acrylonitrile butadiene styrene)

ABS is a low-density material with a higher tensile strength and lower temperature rating than PVC-U.

Any ABS piping to be used shall comply with AS 3518.1. ABS can be supplied with a flush internal and external screw joint, as well as a tapered solvent-weld flush internal and external joint.

FRP (Fibreglass-reinforced polyester) and FRE (Fibreglass-reinforced epoxy)

FRP casing is usually referred to as fibreglass casing as the reinforcing fibre is normally glass strands. Fibreglass casing has a higher collapse strength to weight ratio than steel. FRP does not require de-rating for temperatures below 80°C. It can also be custom-made for particular application requirements (e.g. with specific collapse and tensile strengths). FRP is used for deep water supply bores in some areas.

FRE is stronger and has higher chemical resistance than FRP.

Stainless steel

A range of grades of stainless steel can be matched to soil water chemistry and temperature to provide a higher corrosive resistance than steel.

Collapse Resistance of Pipes or Casings

A comparison of typical strengths of casing materials is shown in Table 9.2.

Casing that is subjected to a high enough pressure externally (or differential pressure) will collapse. For any given diameter-to-wall thickness ratio, there is a critical collapse pressure at which the pipe wall will fail.

See Mandatory Requirement 9.4 for details of maximum potential pressure differentials for PVC-U bore casing.

Differential pressures can arise during formation pressures, cementing, development, and pumping. The expected differential pressure in plastic casing will determine the wall thickness.

For PVC-U, the maximum differential pressures that should be allowed range from 12 kPa per metre head (for an evenly compacted non-clayey-filled bore annulus) to 23 kPa per metre head (for bores in swelling clays).

Plastic casing should not be set to a depth in unconsolidated formations where the maximum potential pressure differential could exceed the collapse rating of the casing. The collapse strength of casing will be affected by slotting the casing.

Table 9.2 Comparison of strengths of bore casing materials

Material	Specific gravity	Tensile strength 103 kPa	Impact strength (relative to PVC-U)	Upper temp. limits (°C)
ABS	1.04	31	x6	50
PVC-U	1.40	55	x1	60
FRP	1.89	115	x20	80 ⁽ⁱ⁾
Steel	7.85	350 (yield)	very high ⁽ⁱⁱ⁾	800–1000
Stainless steel	8.00	517 (yield)	very high ⁽ⁱⁱ⁾	800–1000

NOTES

- (i) FRP higher temperature with special resins.
- (ii) The impact strength of steel and stainless steel is so high relative to PVC-U and to the demands of water well work, that it is generally not a design consideration.

Table 9.3 PVC-U temperature derating

Degrees C	Maximum strength (%)
23	100
27	88
32	75
38	62
43	50
49	40
54	30
60	22

Source: *Groundwater & Wells*, 3rd edn, Johnson Screens, 2008.

Mandatory Requirements

9.1 The minimum casing size shall be 100 mm, excluding for monitoring wells.

The casing and casing joints shall withstand the pressures imposed during the installation and operation of a water bore.

All casing joints shall be aligned, secure, and leakproof.

The appropriate PVC cleaner and Type P solvent cement (AS/NZ 3879) should be used to solvent weld PVC-U pipe.

9.2 The casing material used shall comply with manufacturer's standards as follows:

Casing Material	Minimum Standard
Steel	AS 1396 steel water bore casing, or AS 1579 arc welded steel pipes and fittings for water and wastewater, or API-5L-350 MPa linepipe
ABS	AS 3518 Acrylonitrile Butadiene Styrene (ABS) pipes and fittings for pressure applications – pipes
PVC-U	AS/NZS 1477 PVC pipes and fittings for pressure applications
FRP	API 15 HR
SS	ASTM A312M Standard Specification for Seamless, Welded, and Heavily Cold Worked Austenitic Stainless Steel Pipes

9.3 The minimum acceptable casing wall thickness shall be:
Stainless steel casing (Grade 304/316 stainless steel)

Nominal diameter (mm)	Minimum wall thickness (mm)	
	Schedule 10	Schedule 40
80	3.05	5.49
90	3.05	5.74
100	3.05	6.02
125	3.40	6.55
150	3.40	7.11
200	3.76	8.18
250	4.19	9.27
300	4.57	9.53
350–450	4.78	9.52
500–550	5.54	9.52
600	6.35	9.52

NOTES:

- Two schedules of stainless steel are generally available in Australia: Schedule 10 and Schedule 40.
- Schedule 10 is the minimum acceptable schedule and is generally used for shallow wells; Schedule 40 is used for deeper applications and for larger diameter bores because of its greater wall strength.

Steel casing or steel tubes (Grade B)

Nominal diameter (mm)	Minimum wall thickness (mm)
101–105	3.6
106–114	4.5
115–219	4.8
220–323	6.4
324–457	9.5

FRP casing

Nominal outside diameter (mm)	Minimum wall thickness (mm)
101–105	5.8
106	6.5
114	6.7
115	7.0
127	7.3
141	7.7
168	8.2
219	8.7
220	10.7
273–323	11.4
324	15.6
355	16.1
406–457	16.7

9.4 PVC casing

PN 9 PVC-U pressure pipe is the minimum class allowed for use as bore casing.

PN 6 PVC-U pipe, PVC-U sewer, PVC-O, PVC-M, and drainage pipe shall not be used.

Maximum potential pressure differential ⁽ⁱ⁾ for PVC-U bore casing (head difference)

PN	Unconsolidated formation/clays (metres head)	Consolidated formation ⁽ⁱⁱ⁾ (metres head)
9	26	60
12	56	110
15	100	200
18	200	300

NOTE:

- (i) PVC-U should be de-rated in pressure rating when temperature exceeds 20°C.
- (ii) The maximum difference in metres between external and internal water level. Includes fully grouted and gravel pack.
- (iii) The tables for minimum wall thickness for Stainless steel and FRP are based on having similar collapse pressure to steel casing of the same diameter (see Table 9.2).

Good Industry Practice

- 9.5 *As a general guide the diameter of the bore casing for high-yield bores shall be approximately 50 mm larger than the pump size specified for the bore.*
- 9.6 *Drillers should always case a bore to such a depth that no part of the pump or column is exposed to open-hole conditions.*
- 9.7 *A casing of inert material should be used in all areas where a corrosive problem from bore water or strata is known to exist.*
- 9.8 *When securing the joint the internal diameter of the casing should not be compromised, for example, by screws, rivets, or welding.*
- 9.9 *Multi-port monitoring bores must be cased and grout sealed over the total depth of the hole.
Access to the monitoring zone is through the perforation of the casing and grout seal.*

10. Maximising Bore Efficiency and Water Entry

Principle:

The method of completion across the water entry zone of the bore should:

- *allow efficient entry of water into the bore*
 - *stabilise the formation*
 - *prevent unacceptable ingress of materials from the formation.*
-
-

Water can enter the bore from the water production zone via the following methods:

- open hole
- slotted or perforated casing
- screens
- gravel pack.

Selecting the correct screen and gravel pack will influence the efficiency of the bore.

Open Hole

The open-hole method can be used if the underlying rock and water-bearing formation are consistently firm and stable.

Casing is required across the unconsolidated section of the bore and into stable formations. The remainder of the hole is then left uncased.

When this method is used, care must be taken to ensure that the surface casing is firmly seated and secured into the rock with grout to protect from possible surface run-off and any undesirable subsurface seepage.

For an open-hole completion to be successful, the formation must be stable. In some cases the formation may be either tiered or layered with dispersed friable or soft materials such as clays or sands. In time, these strata can collapse and bridge the hole. This can result in pump damage.

Under these conditions it is necessary to provide some form of support for the strata, while at the same time allowing adequate entry of water into the bore. This is achieved by the use of slotted casing or a screen.

An example of an open-hole bore construction is shown in Figure 10.1.

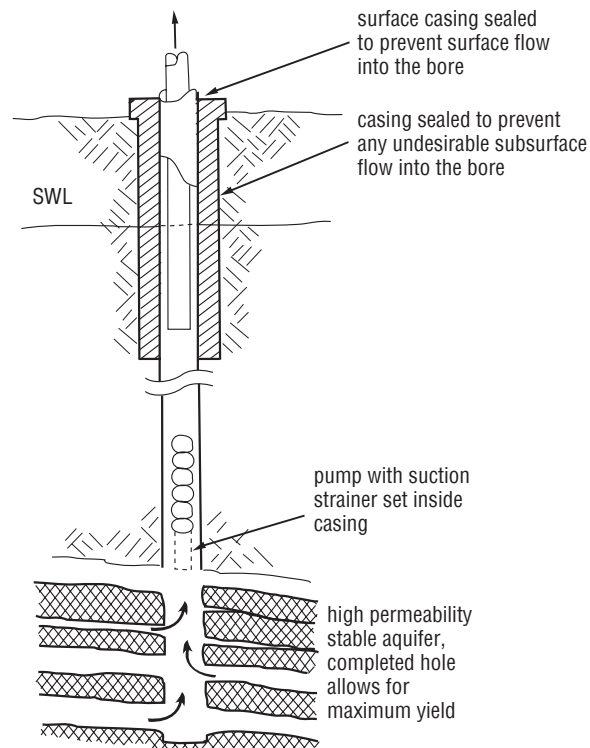

Figure 10.1 Example of an open-hole bore construction

Slotted and Perforated Bore Casing

Another method of construction is to fully case the hole and use slots cut into the casing opposite the water-bearing zone(s) to allow water to enter the bore.

Slots made in the casing can be cut on-site using an oxyacetylene kit (for steel casing) or an electric drill or saw (for plastic casing). However, the preferred method is to use factory machine slotted, drilled, or perforated casing with a regular series of fine or small perforations.

Slotted casing that corresponds to the thickness of the aquifer is normally used. The use of numerous short, narrow slots located to maintain maximum compressive strength in the casing rather than a few large slots is preferable. Suitably placed perforations such as small-diameter round holes may also be used. Examples of slotting are shown in Figure 10.2.

A major problem in using slotted casing is finding the optimum size and shape of slot that will permit adequate flow but continue to retain the water-bearing strata over time.

Slots alone may not be sufficient in relatively fine, loose formations. In these instances, placing a suitable graded well-rounded (not crushed) gravel pack in the annulus between the casing and hole wall will assist in retaining the strata while allowing the water to pass through. This technique is called gravel packing. If gravel packing is used, the bottom open end of the casing must be capped to prevent gravel from entering the casing.

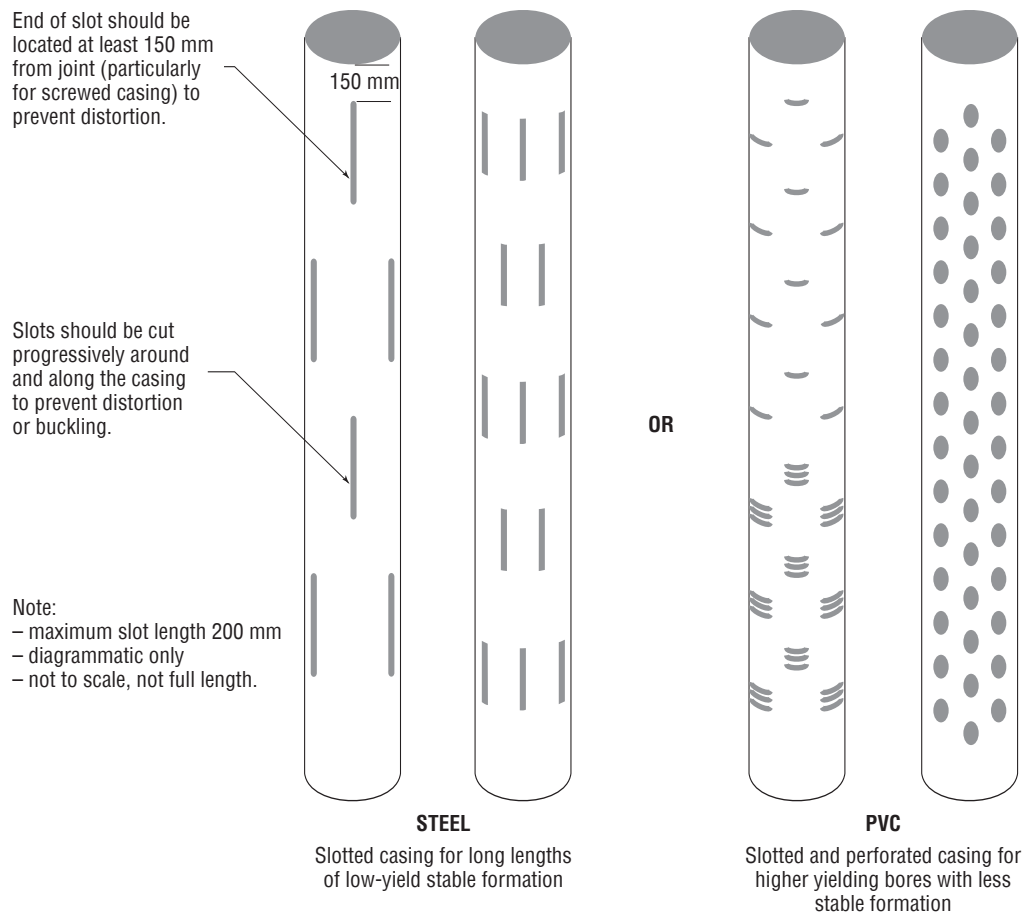

Figure 10.2 Examples of perforated and slotted casing

The slots should be narrow enough to hold out the gravel.

Where gravel fill is to be placed in and above a slotted zone or screen, the annulus must be greater than four times the graded size of the gravel. That is, for 6 mm gravel the hole size must be at least 48 mm larger than the largest outside diameter on the casing used (24 mm larger on each side), usually found to be at the joint, to avoid bridging.

Screens

Many of the larger supplies of bore water are obtained from loose, unconsolidated formations such as sands or gravels, which must be supported if the bore is to remain open. Sands and gravels are not suited to open-hole or slotted casing methods of construction, and in these instances a bore screen is used.

Screens are normally manufactured from stainless steel but are also available in other materials in a number of designs.

Screens usually consist of wedge-shaped wires wound around a frame of axial rods of open cylindrical form. The gap or slot between adjacent turns of the winding is adjusted during manufacture to provide the desired aperture size.

The screen is placed into the borehole within a string of casing and adjacent to the water-bearing formation. It provides support for the formation material and retains an open framework of sand or gravel particles naturally occurring in the formation or deliberately placed around the screen. This arrangement provides for maximum water entry where screens are used.

A hole drilled only slightly larger than the casing and screen diameter is satisfactory if the water-bearing formation is a reasonable mix of sand, coarse sand, and gravels, with no silt or clay layers, and less than 10 per cent fine sand.

For this type of formation and construction it is usual to select a screen aperture size that will retain approximately 40–60 per cent of the sieved water-bearing formation. This allows the fines within the formation, which slow and restrict water entry, to be flushed through the screen into the bore and to be removed during subsequent development of the bore.

A zone of higher material permeability is created around the screen and this increases the yield of water from the bore.

Sometimes a screen is selected with a number of different aperture sizes to match finer or coarser layers in the water-bearing formation. Screens can be either:

- telescopic — where the screen slides inside the casing
- or
- in-line — where the casing and the screen are a continuous string.

The screen diameter either permits a slide fit inside the selected casing for a telescopic setting or the same outside diameter as the bore casing, where the hole can be drilled first and then the casing and the screen run into the hole as a continuous string.

When using telescopic screens, care should be taken with all down-hole measurements as they are critical to the success of the bore.

Screens should always be sealed at the bottom.

The hole bottom should be accurately measured and be clean and proven to be stable enough to support the screen. The sealing tube on the screen should be designed to overlap into the casing by at least 1 metre. Overexposure of the screen seal tube can result in loss of the screen or loss of the bore.

If the water-bearing formation is thick enough, the screen length is calculated by checking the ability of the selected screen (diameter and aperture) to allow the desired water supply into the bore at a reasonable entrance velocity. The recommended design entrance velocity of water through the screen is 30 mm per second.

The screen is usually set in the most permeable section of the formation, and geophysical testing may be required to locate the most productive zones. Salinity may also be a factor in determining where screens are set.

Sieve Analysis

Careful sampling of the water-bearing formation must be carried out during drilling in order to determine the appropriate construction procedure, screen aperture, or gravel pack size. It should be noted that any loss of fines to hole fluids can affect the accuracy of the sample test results.

The samples should be checked and, if necessary, dried and sieved through a nest of sieves so that an accurate analysis of grain size of the formation can be made. This involves the stacked set of brass or stainless steel sieves usually of 200 mm diameter (see Figure 10.3).

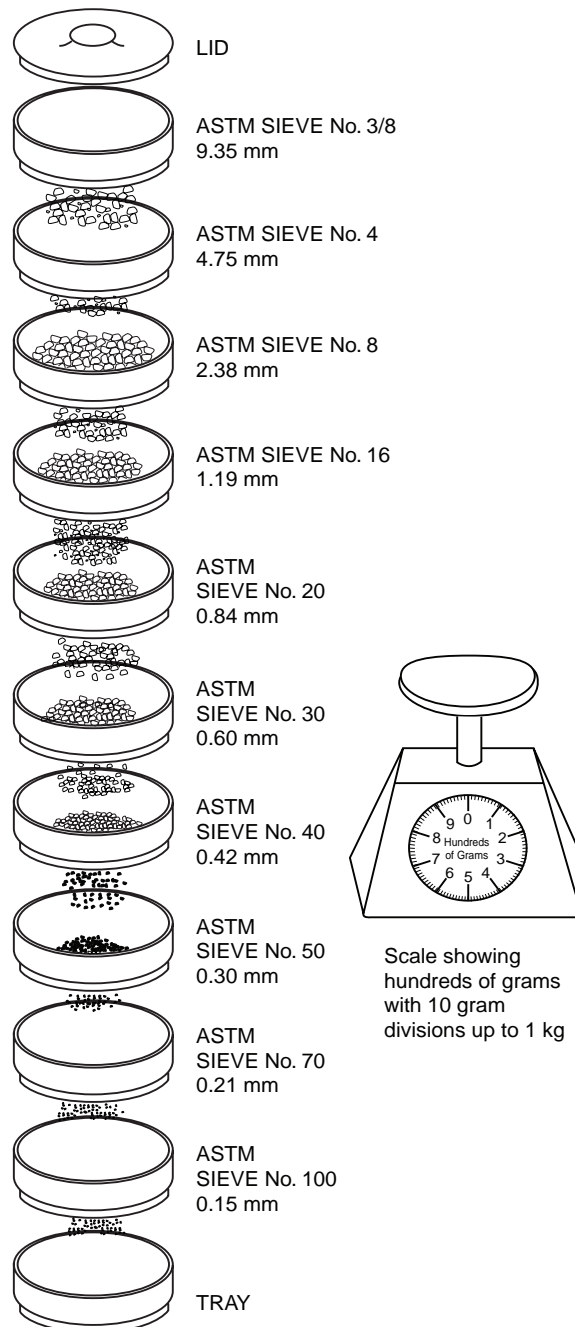

Figure 10.3 Stacked set of sieves used to provide a grain distribution curve

SIEVE ANALYSIS REPORT

EXAMPLE

CLIENT: *Bill Brown*
 BORE NO.: *123456* SAMPLE NO.: *1*
 ADITC REFERENCE NO.: *413*
 REMARKS:

Modal Size = Greatest Mass Retained
 = 0.21 mm on Sieve No. 70
 Then 0.21 X 5 = 1.05 mm Pack Material
 Screen Aperture selected is 20% smaller
 than pack material i.e. 1.05 x 0.8 = 0.84 mm

SIEVE ANALYSIS

Sample Mass: 448.6 g

Method of Bore Construction:
 Natural Pack
 Gravel Pack
 Recommended Screen Slot Size:
0.8 mm
 % Passing: _____
 Gravel Pack Grain Size: 1 mm

ASTM SIEVE NO.	APERTURE		INDIVIDUAL	CUMULATIVE	
	mm	in.	WT. RETAINED	WT. RETAINED	% RETAINED
3/8"	9.53	0.375	0	0	0
4	4.75	0.187	0	0	0
8	2.38	0.094	0	0	0
16	1.19	0.047	8.76	8.76	2
20	0.84	0.033	28.28	37.04	8
30	0.60	0.023	35.04	72.08	16
40	0.42	0.016	26.28	98.36	22
50	0.30	0.012	48.18	146.54	33
70	0.21	0.008	245.28	391.82	87
100	0.15	0.006	48.18	440.00	98
TRAY			8.60	448.60	100

GRAPH OF ANALYSIS

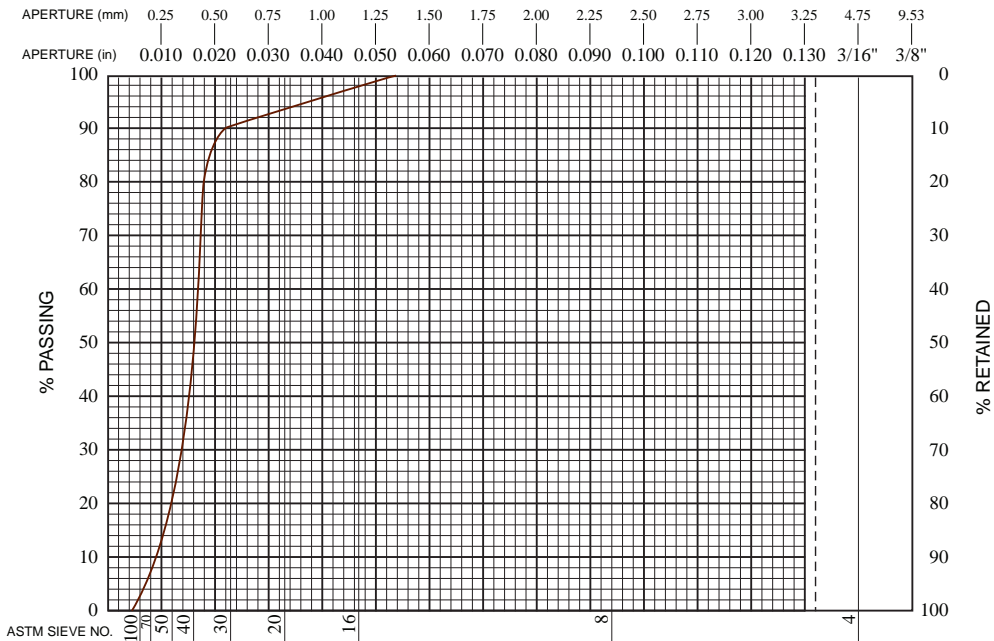

SILT	VERY FINE SAND	FINE SAND	MEDIUM SAND	COARSE SAND	VERY COARSE SAND	FINE GRAVEL	MEDIUM GRAVEL	COARSE GRAVEL
------	----------------	-----------	-------------	-------------	------------------	-------------	---------------	---------------

Name: _____ Signature: _____ Date: _____

Figure 10.4 Example of a sieve analysis report

The apertures in stacked sieve sets typically conform to the American Society for Testing and Materials (ASTM) international standards.

During the sieving process the stack is shaken and each sieve filters out a particular grain size. Each grain size can then be expressed as a percentage of the entire sample, with the finest material collecting in the bottom pan. A plot is then made of the percentage (by weight) of each sample to the whole to provide an indication of the physical make-up of the sample.

An example of a grain distribution plot is shown in Figure 10.4.

Gravel Packing

A gravel pack is recommended where the water-bearing formation is so fine, silty, or layered that the aperture of a screen would be so fine that it would severely affect the flow of water into the bore, or where additional support for the aquifer zone and strata is needed.

See Chapter 12 for more details about bore development.

The grain size and gradation of the filter are selected to stabilise the aquifer material and to permit only the fine fractions to move into the bore during development. After proper development, a correctly filtered bore should be sand-free, and near well permeability improved.

The gravel pack should consist of washed, well-rounded gravel of selected grain size and gradation. It should be uniformly placed in the annular space between the screen and the wall of the borehole.

Based on the sieve analysis results, the gravel pack material should be five times the diameter of the modal size.

Ideally, the aperture of the screen selected should be 20 per cent smaller than the gravel pack size. If this is not possible because of the formation grain size, head loss may result from reduced entrance velocity.

The gravel pack has a considerably higher permeability than the formation, and this increases the efficiency and specific capacity of a bore.

Good Industry Practice

General

10.1 *Maximise bore efficiency by selecting the appropriate completion method. Factors to be considered include:*

- *the aperture and area of the screen or slotted or perforated casing*
- *the size of the gravel pack*
- *characteristics of the formation material*
- *consideration of the desired bore yield.*

Slotted Casing

10.2 The casing should be slotted to minimise the loss of strength in the original casing material. This can be achieved by:

- numerous short narrow slots in a regular pattern rather than long, wide, randomly placed slots
- using short horizontal slots or small round perforations for unreinforced plastic-type casing.

NOTE: Care should be taken to ensure that vertical slots are not deformed by external pressure.

10.3 Slots should be positioned across the full circumference of the bore to suit the likely yield. The total open area of the slots should be at least twice the cross-sectional open area of the casing to limit water entrance velocity through the slots.

10.4 To reduce the risk of silting, slotted casing should not be placed against any non-aquifer material.

Screens

10.5 Screens should be designed to maintain their integrity during installation, development, and use.

Gravel Pack

10.6 The gravel pack should consist of washed, well-rounded gravel of selected grain size and gradation. Crushed stone or rock is not recommended. Furthermore:

- for maximum efficiency of the gravel pack, thin, flat, or elongated pieces should not be used
- no more than 5 per cent of the gravel should be soluble in hydrochloric acid
- the material should be washed and free of shale, mica, clay, dirt, loam, and organic impurities of any kind.

10.7 Gravel packs should be 50–120 mm thick, although 100 mm is the recommended minimum annular thickness to allow for proper placement of the gravel pack material.

It is recommended that:

- the gravel pack material should be five times larger than the modal grain size of the formation material
- the pack shall be much more permeable than the formation material
- at the same time, it shall be fine enough to control the sand

See Chapter 12 for more information about bore development.

- *it shall support the formation without sand movement at the maximum pumping rate.*

The gravel pack shall be developed after installation.

As gravel packs are generally used against uniformly graded fine sands, the grain size of the packing material should also be uniform. There should not be much material either smaller or larger than nominal gravel pack size (i.e. the size should be consistent).

The screen to be run in a gravel-packed bore shall have an aperture designed to retain 80–100 per cent of the pack material.

- 10.9 *The gravel pack material should be placed in the annular space slightly below and adjacent to the bore screens and should extend above the screen to allow for settlement during development.*

A gravel pack top-up pipe may be incorporated into the annulus.

- 10.10 *Centralisers should be used on the screen assembly and be constructed of inert material or the same material as the screen. They should be placed at the top and bottom of the screen and at no greater than 6-metre intervals for long lengths, to reasonably ensure the screened area is covered by a uniform thickness of gravel pack.*

- 10.11 *Methods of sampling should be according to AS 1141.11.1 Methods for Sampling and Testing Aggregates.*

- 10.12 *Gravel should be placed with care to ensure continuity of the gravel pack and to avoid bridging, voids, or segregation.*

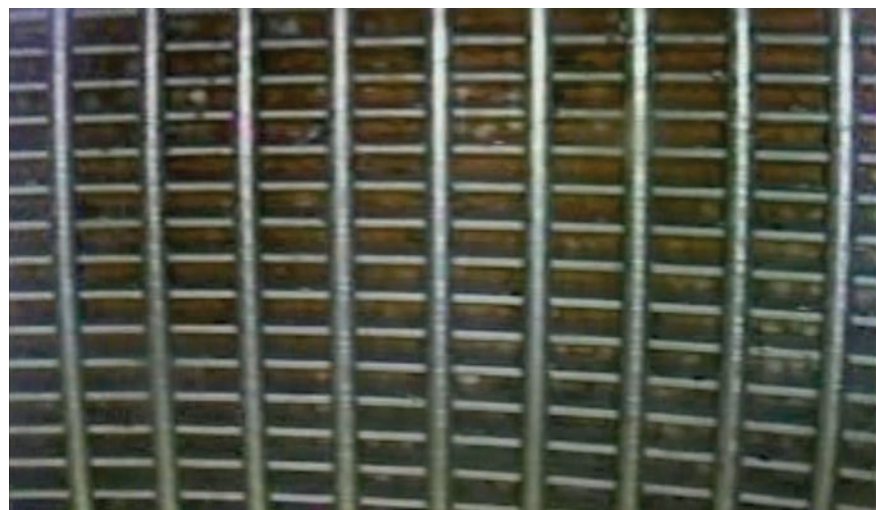

Downhole images of screens and gravel packs
published with permission from Age Developments Pty Ltd

11. Bore Sealing

Principle:

Bores are sealed to:

- *protect the groundwater resource from contamination*
 - *maintain aquifer pressures and quality*
 - *isolate the targeted production zone from other formations.*
-

A range of methods and materials are used to seal bores. These include:

- cement grout — (cement powder, water, and additives)
- concrete — (cement and aggregate mix)
- bentonite — (chips and pellets).

The purpose of sealing is to:

- seal the annular space between the casing and the borehole to maintain aquifer pressures and to prevent the transfer of water between zones
- seal off aquifers containing poor-quality water
- protect the integrity of the casing from corrosive soils and waters
- prevent surface water run-off or shallow subsoil contamination or pollution from reaching the aquifers
- prevent uncontrolled flow at the surface in artesian wells
- isolate the targeted production zone from other formations.

Some water authorities have maps that delineate known areas of strata and water that are corrosive to steel casing. In these areas the authority may request as a construction requirement or bore permit condition the use of plastic type casing or the grouting of steel casing.

Supervision of Cementing

State and territory regulatory authorities may require notification for onsite monitoring or supervision of all cementing operations by an authorised officer. This requirement may be stated in the bore permit.

Effective Sealing

To be effective, a seal must provide a continuous dense lining that completely surrounds the casing. To achieve this:

- The hole must have been drilled large enough to provide adequate clearance between the borehole wall and casing.

See Chapter 7 for more information about using drilling fluids.

- The hole should be conditioned before cementing to ensure:
 - free circulation
 - low circulation pressures
 - full return of circulation
 - hole formation stability.
- The casing should be centred in the hole by means of mechanical centralisers. In corrosive water areas, centralisers should be of inert material, or material of a similar grade to the casing to which they will be attached.
- Unrestricted circulation down the casing and up the annulus must be obtained.
- The hole and casing volume must be calculated, and allowance should be made for washouts and formation losses.
- Direct contact between the cement grout and drill fluid should be avoided. Common drilling practice is to pump a volume of clean water ahead of the grout to provide a spacer between the cement grout and the drilling fluid, or to use a neat-fitting, drillable bottom plug.
- The specific gravity of the cements and drill fluids should be as close as possible to minimise channelling.
- Grout should be pumped into place as quickly as possible.

For all bores where the grout is to be placed under the fluid level, positive placement of grout by a tremie pipe or pressure cementing is to be used. Positive placement of grout from the bottom of the hole upward will usually ensure a complete seal of the annulus space behind the casing.

Potable or good quality water should be used wherever possible. Water should not contain any visible traces of oils, fats, detergents, suspended plant materials, or odour. Poor quality water should be avoided because it may result in grout or sealing failure.

High levels of chlorine in the mix water can retard the setting of the grout.

Adding soda ash or lime can raise a low pH to the desired level.

Adding acid can lower a high pH to the desired level.

Grout should be allowed at least 24 hours curing time before any further downhole drilling activities are carried out.

Some accelerating or retarding admixtures, such as calcium chloride, can cause corrosion of steel and should not be added to the grout. In most cases the use of chlorides is not permitted. Advice should be sought before using accelerators, retarders, or other admixtures.

Recommended cement–water and cement–bentonite–water mixes are listed in Tables 11.1 and 11.2.

Table 11.1a Recommended cement–water mixes
Basic mix using Portland (GP) cement

Number of 20 kg bags of cement	Litres of mixing water ⁽ⁱ⁾	Litres of grout	Specific Gravity (SG)
1	15	21.30	1.64
1	12.5	18.83	1.72 ⁽ⁱⁱ⁾
1	10	16.33	1.83 ⁽ⁱⁱ⁾

NOTES:

- (i) Cement will settle out of the grout if a mix ratio greater than 17.5 litres of water per 20 kg of cement is used in a basic mix of cement and water only (i.e. without other additives).
- (ii) Plasticiser cement additive can be used to improve and extend the workability of the mix and reduce friction while pumping high SG grouts.
- (iii) Portland cement is commonly marked as G.P. or General Purpose cement. Blended cement is marked as G.B. or Builders cement.

Table 11.1b Recommended cement–water mixes
Basic mix using Builders cement (25% Fly Ash)

Number of 20 kg bags of cement	Litres of mixing water	Litres of grout	Specific Gravity (SG)
1	15	21.84	1.60
1	13.75	20.59	1.64
1	12.5	19.34	1.68
1	10	16.84	1.78

Table 11.2a Recommended cement–bentonite–water mixes
using Portland (GP) cement

Cement 20 kg bags	Bentonite in mix ⁽ⁱ⁾ (%)	Mass of bentonite (kg)	Volume of water (litres) ⁽ⁱⁱ⁾	Yield (litres)	Specific Gravity (SG)	Firmness
1	1	0.2	17.5	23.90	1.57	Hard
1	2	0.4	20	26.49	1.52	
1	2.5	0.5	21.25	27.78	1.50	
1	3	0.6	22.5	29.07	1.48	V Firm
1	4	0.8	25	31.65	1.45	
1	5	1.0	27.5	34.23	1.42	

NOTES: Mixing instructions — mix bentonite into water first, and then add cement. Bentonite mixes should have 50 seconds minimum viscosity. Add more bentonite to increase viscosity.

- (i) A 10% or greater bentonite mix is not recommended for normal cementing operations. The percentage recommended is based on bentonite not being hydrated before mixing with cement.
- (ii) Bentonite volumes are only a guide — mixes can be affected by water quality.

Table 11.2b Recommended cement–bentonite–water mixes using Builders cement (25% Fly Ash)

Cement 20 kg bags	Bentonite in mix ⁽ⁱ⁾ (%)	Mass of bentonite (kg)	Volume of water (litres) ⁽ⁱⁱ⁾	Yield (litres)	Specific Gravity (SG)	Firmness
1	1	0.2	17.5	24.34	1.55	Hard
1	2	0.4	20	26.84	1.51	
1	2.5	0.5	21.25	28.09	1.49	
1	3	0.6	22.5	29.34	1.47	V Firm
1	4	0.8	25	31.84	1.44	
1	5	1.0	27.5	34.34	1.41	

NOTES: Mixing instructions — mix bentonite into water first, and then add cement.
Add more bentonite to increase viscosity.

- (i) A 10% or greater bentonite mix is not recommended for normal cementing operations. The percentage recommended is based on bentonite not being hydrated before mixing with cement.
- (ii) Bentonite mixes can be affected by the quality of water used.

Decreasing the Specific Gravity

Bentonite

Bentonite is a naturally occurring clay material that is added to a cement mix to decrease its specific gravity. Bentonite has the ability to absorb many times its own weight of water and to swell to many times its original volume.

As an admixture to cement, common bentonite allows the use of much more mixing water in the slurry before water separation occurs. It provides a lower specific gravity, an increase in slurry yield per bag of cement, a smooth grout, and reduced shrinkage in the cement as it sets in the bore.

Bentonite also gives the grout better sealing properties in porous formations, but it also decreases the strength. However, this should not greatly affect the final result when it is used only as a seal.

Hollow spheres

Microspheres/microcells/hollow spheres are manufactured, free-flowing, hollow ceramic or glass spheres that are used as an additive in cementing to reduce the grout density. They look like uniform fine sands.

Recommended light cement mixes incorporating bentonite and microcells to decrease the specific gravity are shown in Table 11.3.

Reducing Setting Time

Accelerators are used to reduce the time taken for the cement grout to set. These admixtures should be used at the dosage rates recommended by the supplier. (These rates should not be exceeded as excess quantities can sometimes have a retarding effect.)

Table 11.3 Recommended light cement mixes using microcells

Cement 20 kg bags	Water (litres)	Microcells (kg)	Bentonite (kg) ⁽ⁱ⁾	Yield (litres)	Specific Gravity (SG)
1	21.15	6.5	0.55	37.0	1.30
1	21.15	4.5	0.55	34.1	1.35

NOTES: Mixing instructions — mix bentonite into water first, then add microcells, then add cement.

More or less bentonite may be required, as the mix must be viscous enough to keep cement and cells in suspension — minimum recommended viscosity is 50 seconds.

- (i) The quantity of bentonite recommended in the table is based on bentonite not being hydrated before mixing with cement.

Calcium chloride is one such accelerator. It is corrosive to steel and should not be used as an accelerator when steel bore casing is used. Most cement additive supply companies have chloride-free admixtures for accelerating the setting time of cement.

Increasing Setting Time

When cementing deep bores with higher pressures and temperatures there is always a danger that the grout will take an initial set (gelling) before being pumped into its final position. Chemical admixtures are also used to retard or increase the setting time of the grout to allow placement over a longer time or to retard setting in higher temperature formations.

Great Artesian Basin

Bores constructed in the Great Artesian Basin must be constructed in accordance with the requirements of the local state and territory licensing authorities, which may be more stringent in some requirements than these minimum construction requirements. Unless authorised by a bore permit, the supply from artesian bores shall be drawn from one primary formation only.

All aquifers and permeable zones, other than the intended production zone, must be grouted off to prevent interconnection.

The outer surface or control casing shall be placed to a minimum depth to allow control of the bore during drilling, seated 10 metres into competent impermeable strata, and cemented from the shoe to the surface. The inner production casing shall be cemented as stated in the bore permit so that the supply of water can be drawn from one primary formation only. All other aquifers and permeable zones shall be cemented off.

In some states or territories the minimum depth of any inter casing cementing requirements will be specified on the bore permit, as may the requirement for onsite monitoring and/or supervision of cementing operations.

Injection Bores

Injection bores, whether single or multiple aquifer, must be fully grouted from the top of the production zone back to the surface in accordance with the principles outlined in this chapter.

Mandatory Requirements

- 11.1 *All bores shall be sealed to protect the production zone against contamination.*
This also includes the annular space between the casings and the borehole.
In multiple aquifer bores there shall also be a seal between the aquifers and permeable zones to prevent intermixing, flow, and contamination.
- 11.2 *All bores shall be sealed from the surface to not less than 5 metres deep or, where the 'production zone' is less than 5 metres below ground level, the sealing shall be from 1 metre above the production zone to the surface.*
- 11.3 *When sealing the surface control casing in artesian bores, the casing shall be:*
- *seated at least 10 metres into competent impermeable strata, and grouted from the shoe to the surface*
 - *sealed with cement grout having a minimum annular thickness of 20 mm above the maximum diameter of the casing (e.g. a coupling or shoe). This can be obtained using centralisers.*
- 11.4 *The production casing shall be:*
- *grouted so that the supply of water can be drawn from one water-bearing formation only*
 - *for non-flowing multiple aquifer bores: grouted from the top of the production zone for a minimum of 10 metres, to seal off any aquifers above the production zone*
 - *for flowing bores: grouted from no more than 30 metres above the production zone to the surface.*
- 11.5 *Bores drilled to provide access to aquifers for the injection of water shall be sealed with cement grout from the top of the production zone to the surface.*
- 11.6 *Multi-port monitoring bores intersecting more than one aquifer shall be cased and sealed with cement grout from the top of the lowest aquifer system back to the surface.*

11.7 *There shall be a minimum thickness of 15 mm of grout seal around the outside of the production casing.*

11.8 *The sealing material shall be one of the following:*

- *cement grout*
- *cement/bentonite grout*
- *bentonite pellets/chips*
- *concrete.*

Cement used for grouting shall conform to Australian Standard AS 3972 for Portland and Blended Cement.

11.9 *When placing the sealing material below the fluid level in the hole, the seal shall be placed from the bottom upward by methods to avoid segregation or dilution of material.*

11.10 *Bentonite pellets/chips shall only be used below the fluid level when sealing the annulus.*

11.11 *Minimum values of specific gravity for cement grout are:*

- *1.6 for cement grout mix*
- *1.39 for cement/bentonite grout mix*
- *1.3 for cement/bentonite/hollow spheres grout mix.*

11.12 *When cementing:*

- *surface casings of artesian bores*
- *all production casings*

a minimum of 24 hours' curing time shall elapse after placing the cement grout before commencing any downhole drilling activity.

11.13 *Water for:*

- *cementing shall be conditioned to have a pH between 6 and 8*
- *cementing/bentonite mix shall be conditioned to have a pH between 7 and 9*
- *grouting of steel casing shall be less than 3000 EC*
- *grouting of inert casing shall be less than 15000 EC.*

11.14 *Additives that are corrosive to the casing material shall not be included in grout sealing mixtures.*

11.15 *Some states and territories (e.g. New South Wales, Northern Territory, Queensland, and South Australia) have specific requirements regarding the bores constructed in the Great Artesian Basin. These requirements shall be complied with, where applicable.*

Good Industry Practice

- 11.16 *Material Safety Data Sheets (MSDS) and manufacturer's recommendations should be available on the drill site for all drilling products used. These should list instructions for handling, recipes, use, potential hazards, and any disposal requirements for the product or container.*
- 11.17 *All aquifers and permeable zones, other than the intended production zone, should be adequately cemented off to prevent interconnection or wastage between zones of differing pressure or water quality.*
- 11.18 *The salinity of the mix water can affect the strength and set time of grout mixes and may be corrosive to non-inert casing. Higher salinity decreases the strength and increase setting times.*



Cementing the bore

12. Bore Development

Principle:

Bores are developed to:

- *remove introduced products*
- *improve near well permeability*
- *reduce entry losses*
- *reduce entry of suspended solids*
- *increase well efficiency.*

Bore development is performed to bring a bore to its maximum production capacity by optimising the bore efficiency, specific capacity, stabilisation of aquifer material, and control of suspended solids.

The development usually involves the use of various chemical and/or mechanical agitation methods, the selection of which will depend on the type of equipment available, the construction of the bore, and the aquifer type.

A number of techniques are used to remove fines and stabilise aquifer material. These include:

- air lifting and jetting
- surging
- pumping
- bailing
- adding dispersants and detergents.

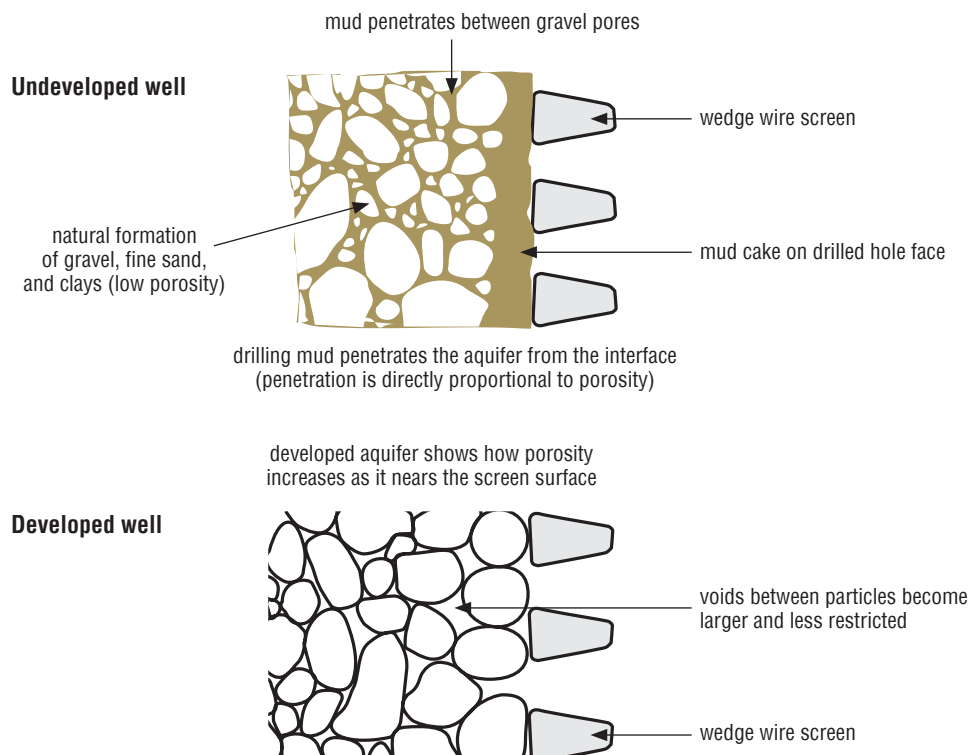

Figure 12.1 Improving bore permeability through development

Use of Chemicals

Chemical methods include the use of dispersants and detergents to wet, break down, and allow clayey materials and fines to be removed from the formation. Final development is usually by mechanical means.

Use of Mechanical Methods

Whatever mechanical method is used, the aim is to remove from the annulus, between the screen and hole wall, clays or compacted material resulting from the drilling operations, as well as the fine material from the water-bearing formation itself.

This results in a rearrangement of the remaining water-bearing formation. The bore development process is illustrated in Figure 12.2.

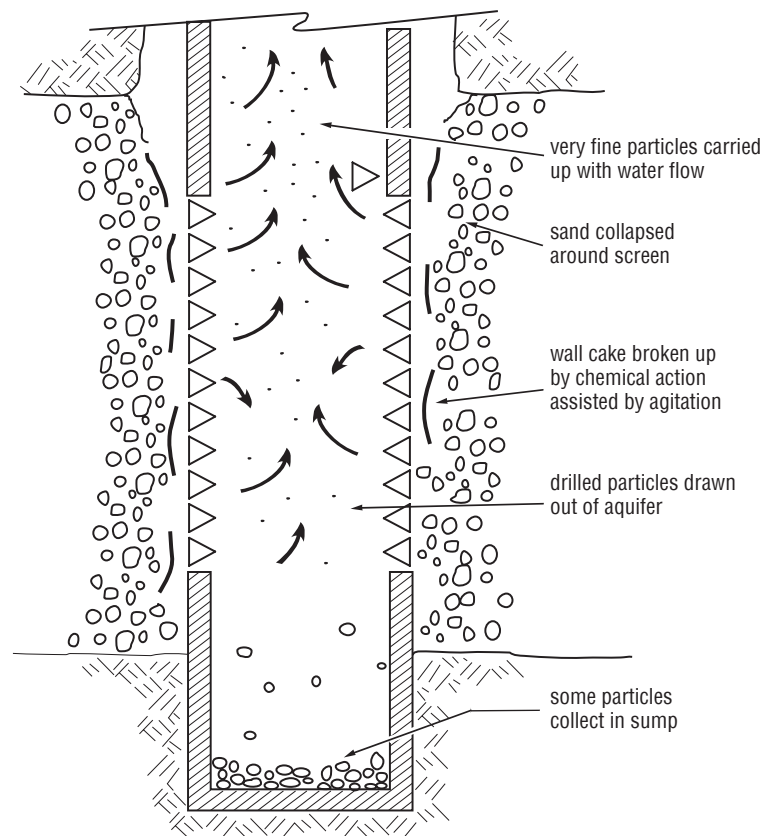

Figure 12.2 The bore development process

During development the fines drawn through the screen are periodically removed from the screen assembly. A small increase in permeability in the vicinity of the screen can result in considerably less drawdown in the bore for the same pumping rate.

The development process should involve techniques that progress from gentle to vigorous agitation.

Rapid de-watering of the bore should be avoided in the early stages of development as it may collapse the screen or casing or, in the case of a telescopic screen, relocate the screen to a higher and undesirable location inside the casing.

As well as increasing the production capacity of a bore, development also stabilises the formation that acts as a filter to prevent the pumping of sand that would otherwise result in serious damage to pumps and fittings.

Sand Content

In most formations the application of appropriate development techniques will result in a virtually sand-free or silt-free bore. Where the aquifer material is very fine, a compromise may have to be reached to achieve an acceptable flow rate and a relatively sand-free supply.

Good Industry Practice

- 12.1 *The bore development process should employ techniques that progress from gentle to vigorous agitation.*
- 12.2 *The development technique should complement the screen design to maximise efficiency.*
- 12.3 *Rapid de-watering of the bore should be avoided in the early stages of development as it may collapse the screen or casing, or move a telescopic screen.*
- 12.4 *Too harsh a technique in the early stages of development can result in reduced yield, or erosion of the screen or slots.*
- 12.5 *During bore development, records should be kept of all observations.*
- 12.6 *The development of a water bore should not be concluded before a continuous clean, silt-free and sand-free supply of water is obtainable at the full flow capability of the bore. A sand-free supply can be regarded as having a sand content of no more than 5mg/1000 litres. After development, the bore shall be left clean and free of any other obstructions for the full depth.*
- 12.7 *A pump can be used for final development of the bore.*

See Chapter 15 for more information about recording and reporting data.

See Chapter 13 for more information about bore yield testing.

12.8 *Development can be considered satisfactory when the following have been achieved.*

- *The bore produces no sand or silt for 1 hour.*
- *The bore is completely clean of particles from the top to the base, and the water is relatively clear and free of fines.*
- *There is no further increase in specific capacity of the bore with continued development.*



Bore yield testing



Mobile pump test unit (small flow)

13. Bore Yield Testing

Principle:

All water supply bores should be tested to establish their indicative yield.

At the completion of bore construction the bore should be tested to provide the client with an indicative yield. During the test procedures it is important that accurate, regular water quantity and quality data is collected. This information is required to enable the client to decide whether to equip the bore and, if so, it will aid in pump selection.

Two types of yield tests are commonly performed:

- tests done by drillers at the completion of bore construction
- formal pumping tests.

Testing by drillers is usually conducted using the drilling equipment available. Measurements involve removing a known volume of water over a known period of time.

An estimate of yield derived from this type of test is, at best, an estimate. To gain a better understanding of safe yield or long-term supply a proper pumping test should be carried out. Results from a properly conducted pumping test can vary by as much as 50% from the original driller estimations.

Pumping tests involve more complex equipment and the measurement of flows, water quality, water level drawdown, and recovery over time.

Various types and durations of pumping tests are listed in Table 13.1.

Table 13.1 Type and duration of pumping test

Purpose of bore	Type of test	Duration of pumping (hours)	Duration of recovery (hours)
Low usage facility (e.g. general stock watering or household)	Constant discharge or variable discharge	4–6	2 (See Note 1.)
Medium or high usage (capital intensive support, e.g. intense stock watering, mining, irrigation, industrial, municipal supply)	Step and constant discharge	24–100 (See Note 2.)	8 (See Note 1.)
Aquifer investigation	Constant discharge (other tests may be appropriate)	Depends on nature of investigation	Depends on nature of investigation

NOTES:

1. Recovery duration is until a trend is definitely established, or to at least 80% of full recovery.
2. The reliability of the prediction of well performance will increase with the duration of the test. A test duration nearer the upper limit is recommended if the consequences of failure to perform as predicted are severe.

Specifically, pumping tests:

- assess the hydraulic behaviour of a bore to determine its usefulness as a source of water
- predict performance under different pumping regimes, and enable determination of the most suitable pump and optimum intake depth
- determine the hydraulic properties of the groundwater system penetrated by the bore. This includes transmissivity, storativity, and the presence, type, and distance of any hydraulic boundaries.

Bore owners are encouraged to allocate sufficient funds for a comprehensive pumping test that can be used as a reliable basis for predicting future performance. It is also essential for pump selection in high-yielding bores.

No more information about pumping tests will be presented in this book as more detailed information is readily available from other hydrogeological references and texts (e.g. AS 2368 Test Pumping of Water Wells).

Bore Testing by Drillers

See Chapter 12 for more information about bore development.

On completion of any production bore, the driller should carry out adequate testing to provide the client with a reasonable indication of the capacity of the bore. This test will also demonstrate to the client if the bore has been constructed properly and is therefore capable of producing clean water.

Air testing

This method is generally used in conjunction with rotary or air drilling and can be performed during drilling on a partly completed open hole. However, the final test must be on the completed, cased, slotted, or screened production bore.

The results of most air tests give an indication only of the available supply. Many physical aspects of the method can vary the results. These variables include:

- hole and drill stem annulus size
- air volume and pressure available
- depth of drill stem submergence.

Air lift pumping without sufficient submergence may not be efficient, therefore air testing may not always produce the full supply available in the bore. Test results to be recorded include:

- standing water level before testing
- depth to bottom of drill stems
- air pressure to lift water
- air pressure during pumping after initial lift
- duration of test

- discharge rate measured as accurately as possible at regular intervals throughout the test, particularly at the end
- water sample collected when water becomes clean and clear (the minimum volume required is one litre)
- final depth after air testing.

The water discharged should be confined in an earth drain or similar, and measured over a weir board of suitable dimensions to determine the discharge rate. If the flow can be diverted through a pipe or fluming, a measuring tank or bucket and stopwatch can be used.



Weir board

Bail testing

Bail testing is more commonly used with cable tool drilling. It involves lowering a 'bailer' of a known volume into the water, allowing it to fill, then withdrawing and emptying it at the surface. The procedure is repeated for the duration of the test. The resultant pump rate is then calculated by multiplying the number of bailers removed in one hour by the volume of the bailer. By dividing the bail rate by the metres of drawdown the yield of the bore can be calculated.

Test results to be recorded include:

- standing water level before testing
- bail rate
- drawdown during bailing
- final drawdown water level
- test duration
- final depth after bailing.

A bailer of known volume with no valve leaks should be used for bailer testing.

The duration of the test may vary, depending on the type of bore, bore depth, available supply, and intended use, but should be long enough to prove that the bore is producing clear, clean, silt-free water.

The water level should be monitored after any testing to ensure the level in the bore is recovering and the aquifer has not been de-watered.



Test pumping an irrigation bore

Good Industry Practice

- 13.1 *On completion of any production, the driller should carry out bore testing to provide the client with a reasonable indication of the capacity of the bore.*
- 13.2 *Testing should continue until either 60 minutes have elapsed or the field water quality measurements have stabilised.*
- 13.3 *Regular flow readings should be made using a measuring device and recorded in L/sec.*
- 13.4 *Field measurements should be taken to determine EC and pH.*
- 13.5 *Water samples for laboratory analysis should be collected at regular intervals during the testing process.*

14. Disinfecting Water Bores

Principles:

Drilling equipment that has been used should be disinfected to prevent the transfer of microbiological organisms (bacteria) between sites.

After completing drilling, the bore should be free of any introduced microbiological organisms (bacteria).

Generally, aquifers contain very limited numbers of microbiological organisms. However, various bacterial sources can be introduced into a bore through the normal use of drilling fluids placed into the bore. In most instances these are naturally occurring bacteria, such as iron bacteria. When introduced in a bore these bacteria can flourish and cause clogging of the screens and water delivery equipment.

The best drilling approach is to limit the introduction of any foreign material to the bore or aquifer, thus minimising exposure of the completed bore to any other contamination pathway for organic organisms. This can be achieved by disinfecting the drilling rig and equipment before drilling the bore.

Disinfecting the bore after construction is good practice, and should be carried out with the aim of inactivating organisms such as bacteria.

Drillers and landholders should make enquiries to determine whether an area in which they propose to work has, or is suspected to have, an iron bacteria problem.

If an area is discovered to have an iron bacteria problem, bore and drilling equipment disinfection is an important part of the overall management strategy to stop the transfer of bacteria between regions.

However, disinfection cannot be regarded as the complete solution to treat bores that have become fouled with iron bacteria. Disinfectants such as chlorine can be effective only after the film that shields the bacteria has been broken down.

Specific treatments of bores fouled by iron bacteria are best tailored to the groundwater chemistry, hydrogeology, and pumping regimes.

In areas of known iron bacterial infestation, specific instructions regarding bore and equipment disinfection exist. In these instances the disinfection is focused on minimising the introduction of nutrient sources into bores and on the spread of bacteria from bore to bore.

A number of chemicals in the marketplace have been produced specifically for bore disinfection. The major benefits claimed for these chemicals over chlorine are that they are:

- non-corrosive
- safe to handle
- environmentally friendly.

Manufacturers can help drillers by providing technical information about their bore disinfection products.

Good Industry Practice

- 14.1 *The driller should ensure that drilling tools are cleaned and disinfected before working on a new site.*
- 14.2 *In an area where iron bacteria is known or suspected to exist, equipment should be chlorine washed or steam cleaned after being used.*
- 14.3 *All bores should be disinfected.
Reference should be made to the relevant local authority regarding the use of industry-approved chemicals before commencing any treatment of bores.*
- 14.4 *Care should be taken with any waste disposal of disinfection agents from the bore after completing drilling.*
- 14.5 *The driller should ensure that after completing drilling a bore is left so that it is not harmful to users, pumps, or the bore itself from chemicals used to disinfect the bore.*

15. Recording and Reporting Data

Principle:

Accurate information on the drilling, construction, reconditioning, and decommissioning is recorded to be available for the use of drillers, landholders, and regulators.

In a continent as dry as Australia it is vital that water resources are used effectively and sustainably. By the nature of their location, groundwater resources are costly to explore and develop.

It is most important therefore that when bores are drilled an accurate and complete record is made of the drilling, construction, reconditioning, and decommissioning processes. These records must be submitted to the relevant state or territory water authority to be added to other data to aid in the development of knowledge about:

- the nature and extent of the groundwater resource
- potential impacts from regional and localised pumping
- the impact of future developments and land use change on regional and localised drawdowns
- the development of groundwater management plans and future groundwater allocations and restrictions
- assisting future drilling operations.

The driller should keep a record of drilling observations in a field book while drilling progresses. These observations should include:

- the accurate location of the bore site
- start and finish dates
- the bore identification number (i.e. a unique identification of the bore site by number or name)
- drill string inventory
- bit types and sizes
- strata details
- details of the aquifer, yield, and water quality
- casing lengths, sizes, and types
- the penetration log
- the drilling method over any particular zone
- the decommissioning method used
- cement grouting details
- hole behaviour
- observed drilling fluid changes and depth.

Where accurate and comprehensive records are provided, this information is of value to the client, landholders, other stakeholders, and state or territory water authorities responsible for the development and management of the resource.

Bore completion report templates are usually available from relevant departments.

Most state and territory water authorities have a bore completion report (or drill log or specific form) they can supply to drillers to detail the information required. As the information required to be submitted may vary between authorities, drillers should ensure they satisfy the requirements of the particular state or territory in which they are working.

Mandatory Requirement

15.1 *A bore completion report shall be supplied as required by the state or territory water licensing authority.*

See Chapters 17 and 18 for more information about bore completion.

Good Industry Practice

15.2 *During the drilling and construction of a bore the driller should keep accurate records. These details should include:*

- *the bore identification or licence number*
- *start and finish dates*
- *the name and address of the client*
- *the name of the driller*
- *the type of drilling method used*
- *the diameters and depth of hole drilled*
- *complete strata details*
- *details of any water supplies cut*
- *casing type and diameter (OD), class of pipe and/or wall thickness, position within the hole, and how it is secured and sealed*
- *cement grouting details*
- *water entry to the bore, for example, length of slotted sections and locations, screen type, dimensions and location, gravel pack material and size*
- *bore development procedure and record*
- *GPS coordinates and/or location sketch of the bore site showing a north point, distances from two adjacent property boundaries or other topographical features, and the real property description*
- *bore disinfection procedures used.*

An example of a bore completion report is included in Figure 15.1.

Guidelines for soil and rock classifications and descriptions are in Tables 15.1 and 15.2.

15.3 *A detailed report, including a diagram of the bore, should be prepared by the driller on the decommissioning of any bore or test hole.*

15.4 *The driller should provide details of the bore construction report and any other relevant information to the client and should also retain a copy.*

Other relevant information could include:

- *results of any pump tests*
- *a description of the water quality*
- *any geophysical logs/parameters that were run.*

Drill log form

Authorisation details
 Registered number _____ Development permit number _____ Works reference number _____

SECTION A—LOCATION DETAILS
 Name of landholder Joe Bloggs Phone No. (07) 5534 9212
 Postal address PO Box 19, Ormeau Postcode 4208
 Real property address 1015 Woogoolpah Road, Jacobs Well Postcode 4208
 Real property description Lot 183 Plan RP14367 or Bore location GPS. Latitude 27° 47' 34" Longitude 153° 21' 46" Datum GDA94
 Easting 535753 Northing 6925715 Zone 56

SECTION B—BORE COMPLETION DETAILS
 Date commenced 23/06/2010
 Date completed 25/06/2010

SECTION C—DRILLING METHOD
 Rotary mud Cable tool
 Auger Rotary air
 Other _____

SECTION D—HOLE SIZE

Diameter (mm)	From	To
250	0	6
240	6	10
195	10	39

SECTION E—CASING DETAILS

Type (PVC, steel etc)	Size O.D. (mm)	Wall thickness (mm)	Location (metres)
			From To
Steel	219	6.4	0 10
PVC	140	Class 12	0 39

SECTION F—CENTRALISERS TYPE

Type	Location (metres)
	From To
Kwik-zip	0 16

SECTION G—PERFORATIONS/ SLOTS/ SCREENS

Type	Size O.D. (mm)	Aperture (mm)	Location (metres)
			From To
	125	0.4	30 36

SECTION H—CEMENTING/ GRAVEL PACK/ ANNULAR FILL DETAILS

Type & material size	Hole diameter (mm)	Casing diameter (mm O.D.)	Location (metres)
			From To
Cement grout	200	140	0 16
Drill cuttings	200	140	16 28
Bentonite seal	200	140	28 29
Gravel pack	200	140	29 39

SECTION I—BORE PURPOSE
 Domestic Stock Irrigation Commercial
 Urban Industrial Other (please specify) _____

SECTION J—PARTICULARS OF STRATA

From (metres)	To (metres)	Strata description (use more than one line if required)	Water bed thus(°)
0	2	Top soil	
2	5	Clay fine silty	
5	9	Sand and gravel (dry)	
9	18	Clay silty brown	
18	27	Sand clay white	½ LPS
27	29	Sand and fine	
29	31	Sand and fine gravel	
31	33	Fine gravel	2 ½ LPS
33	35	Clay brown	
35	37	Weathered granite	1 LPS
37	39	Hard granite	

SECTION K—WATER BEARING BEDS

Depth struck (metres)	Water rose to (metres)	Supply (litres/second)	Quality (e.g. potable, brackish, salty)
31	16	4	Potable

SECTION L—SUB ARTESIAN BORE ON COMPLETION
 Conductivity(EC) 111 pH 7.1
 Depth to standing water level from ground level 16 (metres)
 Depth to pump suction or bottom of drill stem 28 (metres)

SECTION M—ARTESIAN BORE ON COMPLETION
 Type of test used Air Bail Pump
 Est. supply 4 (litres/second) Duration of test 3 (hours) Drawdown level from surface 28 (metres)

SECTION N—REMARKS
 Pressure _____ Free flow (litres/second) _____ Temperature _____
 Pull steel casing before cementing to 16 metres with tremi pipe
 Mud viscosity 52 + mud weight 1.03

SECTION O—CERTIFICATION
 I hereby certify that the bore is drilled and constructed according to the conditions of my driller's licence and the information provided in sections A to E and section H above is true, accurate and complete to the best of my knowledge and belief.

Driller D. Rigg Driller's Licence No. 4234
 Trainee Driller R. Mud Driller's Licence No. 5678
 Signature of Driller D. Rigg Date 25/06/2011
 Contractor The Big Aussie Drill

Department of Environment and Resource Management
 The information being collected in this form will be used by this department for the purpose of processing your drill log form to record your water bore drilling activity under the authority of section 39 of the Water Act 2009. Your personal details will be accessed only by authorised officers within this department and will not be disclosed to any other third party without your consent except where required by law. The information collected will be retained as required by law. The information collected will be retained as required by law. The information collected will be retained as required by law. The information collected will be retained as required by law.

Figure 15.1 Example of a bore completion report/drill log

Rock Types

Geologists classify rock types in three major groups:

- Igneous rocks — those which have cooled and solidified from an originally molten mass
- Sedimentary rocks — those resulting from the deposition of sediments by water, wind, or chemical precipitation and later consolidation
- Metamorphic rocks — those from either of the first two groups which have been altered by heat, pressure, solution, or other means.

Rocks are further classified according to particle size. Igneous rocks include coarse-grained types such as granite and gabbro, and the fine-grained types such as rhyolite and basalt. The coarse-grained types have cooled and become solid at great depths under the earth's surface whereas the fine-grained rocks have cooled at or near the surface (such as lava flows). In rocks such as granite, water is found in joints or fractures in the rock and occasionally in the upper weathered zone of the rock. Normally only a small amount of water can be obtained from bores drilled in such rocks. Some lava flow type of igneous rocks, however, may be quite porous and bores penetrating those porous zones may yield a considerable quantity of water.

Sedimentary rocks include shale, sandstone, conglomerate, limestone, dolomite, etc. These rocks are the result of compaction and consolidation of loose sediments such as clay, sand fossil shells, etc., and chemical precipitates or evaporation product such as salt and gypsum.

The terms clay, silt, sand, and gravel properly refer only to the size of the particles that compose the sediment.

Water is often found in abundance between the particles of medium and coarse-grained unconsolidated sediments such as sand and gravel. Fine-grained sediments, such as clay, may contain much moisture but due to the small size of the clay particles and the pore space between these particles it is difficult to obtain water from such sediments.

When the sediments become consolidated to form a sedimentary rock, the proper rock name is applied – clay becoming shale, sand becoming sandstone, gravel becoming conglomerate, etc. Water occurs in these rocks just as in the original unconsolidated sediments, but due to compaction and sedimentation the porosity of the rock is usually less than that of the original loose material.

Limestone is a sedimentary rock composed chiefly of calcium carbonate (lime), which was formed by precipitation of a fine-grained limey mud, by the accumulation of many animal shells in oceans or lakes, or by other means. Dolomite is another rock similar in most respects to limestone but containing calcium and magnesium carbonates. Dolomite does not effervesce or 'fizz' as rapidly to dilute hydrochloric acid in the way that limestone does. Since limestone and dolomite are somewhat soluble in water, solution openings and cavities up to the size of large caves may be formed.

Groundwater may be obtained from small pores of limestone or dolomite, just as in sandstone, but most water is obtained from cracks, crevices, and larger solution openings.

Metamorphic rocks include slate, quartzite, marble, schist, gneiss, etc. They are the result of long action of heat, pressure, and solutions upon igneous and sedimentary rocks. With the exception of marble, which is a metamorphosed limestone, most rocks in this group are dense and only small quantities of water can be obtained from cracks or joints. Marble may contain larger solution openings, similar to those found in limestone, from which abundant supplies of water can be obtained.

Geologists group certain rock units which can be mapped and traced by the study of bore cutting and field mapping over a large areas into 'formations'. Each formation is given a name, usually referring to some geographical place where the formation is well exposed at the surface.

(Source: *Water Well Handbook*, 1971. Missouri Water Well & Pump Contractors Association Incorporated.)

Classification of Granular Materials and Approximate Slot Size for Naturally Developed Wells					
Name	Millimeters	Inches	Sieve Size	Slot Size (inches)	Slot Size (mm)
Boulders	>300	>11.8	>12"	>0.100	>2.5
Cobbles	300 - 75	11.8 - 2.9	12" - 3"	>0.100	>2.5
Gravel - coarse	75 - 19	2.90 - 0.75	3" - 3/4"	>0.100	>2.5
Gravel - fine	19 - 4.8	0.75 - 0.19	3/4" - 4	>0.100	>2.5
Sand - coarse	4.8 - 2.0	0.19 - 0.08	4 - 10	0.100	2.5
Sand - coarse to medium	3.3 - 1.8	0.13 - 0.07	6 - 12	0.090	2.3
Sand - medium	2.2 - 1.3	0.09 - 0.05	8 - 16	0.070	1.8
Sand - medium	1.8 - 1.0	0.07 - 0.04	12 - 20	0.050	1.3
Sand - medium	1.3 - 0.5	0.05 - 0.02	16 - 30	0.030	0.8
Sand - fine	0.5 - 0.2	0.02 - 0.008	30 - 70	0.015	0.4
Sand - fine	0.2 - 0.08	0.008 - 0.003	30 - 200	0.007	0.2
Slits and Clays	<0.08	<0.003	<200	NA	NA

Grain size classification is based on USCS and slot selection is based on well construction using natural development and average grain sizes.

Screen Slot Gauge in/mm	
0.100	2.54
0.080	2.03
0.060	1.52
0.050	1.27
0.040	1.02
0.030	0.76
0.020	0.51
0.010	0.25

Sand / Slot Size Gauge						
Gauge	Name	Natural Development Slot		Filter Pack Slot		
		inches	mm	sieve	inches	mm
	Gravel	0.125	3.2	3/8" - 3/4"	0.250	6.4
	Sand - Coarse	0.100	2.5	4 - 3/8"	0.160	4.1
		0.080	2.0	3 - 6	0.120	3.0
	Sand - Medium	0.060	1.5	4 - 8	0.090	2.3
		0.040	1.0	6 - 12	0.070	1.8
	Sand - Fine	0.020	0.5	10 - 20	0.040	1.0
		0.007	0.2	20 - 40	0.018	0.5

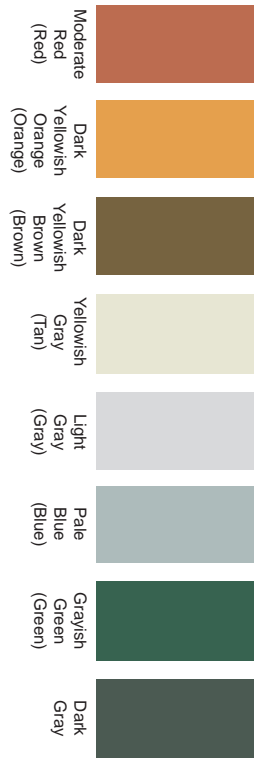
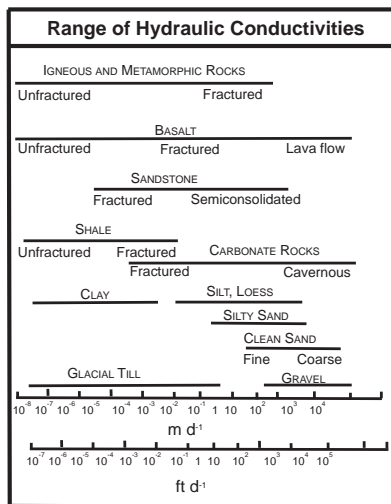
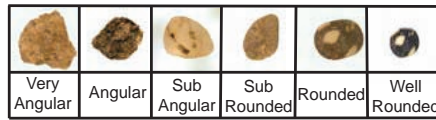

© 2007 Weatherford JS-BR7200-1207

Table 15 Guidelines for rock classification and description

Johnson screens®
A Weatherford Company
Thomas M. Hanna, RPG



Heavy duty borehead protection

16. Bore Completion, Headworks, and Site Restoration

Principles:

Headworks shall control the flow of water.

The protruding casing should be completed so that it:

- is protected from damage*
- prevents surface run-off or potentially contaminated fluids from entering the bore.*

After completion of the job the site should be restored as close as possible to its original condition.

Headworks

After a bore has been drilled and tested it is important to secure the bore and protect it from damage and from the entry of any contaminants. These works may include:

- installing headworks
- sealing and capping to protect the aquifer.

It is also important to:

- protect the bore from environmental conditions such as flooding, sunlight, vandalism, fauna, insects, and fire
- dispose of any waste or potentially hazardous materials
- restore the site.

If the bore has to be located in an area of potential flooding, the casing should be raised above flood level or, if this is not feasible, completely sealed to prevent the entry of floodwater.

Tongue type valves (gate valves) should be used on artesian bores and headworks to assist in reducing water hammer that can result from rapid closing of other valve types.

Figure 16.1 shows an example of headworks design for a flowing bore.

Restoring the Drilling Site and Waste Disposal

It is important for health, safety, regulatory requirements, and environmental protection that any unwanted materials and waste products are disposed of responsibly.

The driller has a responsibility to restore the drill site. The site should be returned, as close as reasonably practicable, to its pre-drilling condition.

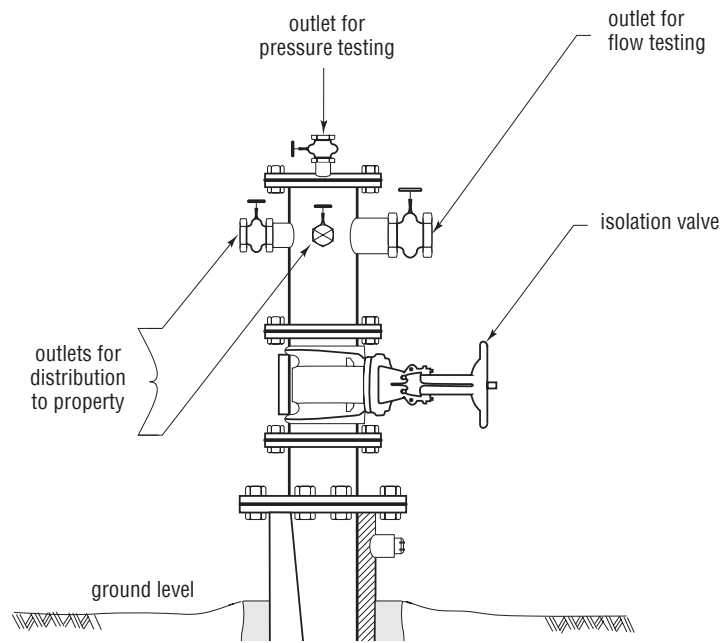

Figure 16.1 An example of headworks design for a flowing bore



Water supply under control



Water supply out of control

Mandatory Requirements

16.1 *The driller shall ensure the bore casing is capped with a suitable threaded, flanged, or welded cap, or a compression seal.*

16.2 *All flowing bores shall be fitted with headworks in such a way as to control the flow of water. NOTE: The design may be specified by state and territory regulators.*

16.3 *When the water temperature exceeds 50°C, or the flow exceeds 15 litres per second, the following requirements apply:*

- *A main isolating valve of equivalent diameter to the inner casing shall be installed below the headworks distribution outlets.*
- *The headworks for flowing artesian bores shall be made to enable testing of pressure and flow, without having to interfere with reticulation or pumping systems.*
- *The flow measurement valve shall comply with the following minimum sizes:*

<i>Flow rate (litres per second)</i>	<i>Minimum valve diameter (mm)</i>
<i>0–10</i>	<i>50</i>
<i>10–30</i>	<i>75</i>
<i>30</i>	<i>100</i>

- *When constructing headworks for flowing bores the materials used shall conform to the following Australian standards:*

Flanges:

- *for headworks shall conform to AS 2129*
- *up to and including 150 mm diameter shall use Table D (with M16 galvanised bolts)*
- *for headworks above 150 mm diameter shall use Table E (with M20 galvanised bolts)*

Valves fitted to the headworks shall comply with either:

- *AS 1628 Water Supply — Metallic Gate, Globe and Non-return Valves*
- *AS 2638 Gate Valves for Waterworks Purposes*
- *AS 3579 Cast Iron Wedge Gate Valves for General Purposes*

Stainless steel pipes and valves shall comply with:

- ASTM A312 Stainless Steel Pipe (American standard)
- API 603 Stainless Steel Flanged Gate Valves. (No standard applies to stainless steel screwed gate valves.)

Good Industry Practice

See Chapter 17 for more information about bore maintenance and rehabilitation.

- 16.4 *Flowing wells should be fitted with a full diameter main isolating valve to assist future bore maintenance and rehabilitation.*
- 16.5 *At all times the driller should ensure precautions are taken to prevent foreign material or surface water from entering the bore.*
- 16.6 *All plastic bore casing should be protected:*
- *If above ground this can be achieved with a steel cover pipe from the top of the bore casing and cemented to a depth not less than 0.5 m.*
 - *If below ground this can be achieved with a cover that provides a complete seal to prevent the entry of any fluids.*
- 16.7 *All bores or wells should be positioned so that the headworks can be protected from frequent flooding and surface water drainage.*
- If the bore is located in an area of potential flooding, the casing should be raised above flood level. If this is not feasible, it should be completely sealed to prevent the entry of floodwater.*
- 16.8 *All containers or bags for chemicals, cement, drilling fluids, and additives should be disposed of in such a way to cause minimum impact on the environment. This shall be done in accordance with the requirements of the respective state, territory, or local authorities, and the client.*
- 16.9 *Any well development and disinfecting chemicals should be neutralised or otherwise disposed of in a safe manner.*
- 16.10 *Mud pits, if used, should be drained and filled in, or arrangements made for the work to be carried out.*
- 16.11 *Drilling camps should be adequately decommissioned, and all waste should be disposed of in an appropriate manner.*

17. Bore Maintenance and Rehabilitation

Principles:

Bore maintenance is intended to preserve performance of the bore and its component parts in good repair.

Rehabilitation is intended to repair a bore that has failed.

Bores, like any constructed asset, can deteriorate with age. This can lead to the bore owner experiencing issues with bore performance and ultimately water supply problems.

The severity of these problems can range from the bore becoming unsuitable for its intended purpose to less significant issues such as encrustation or scaling.

No matter the complexity or size of the problem, each will cause some level of inconvenience to, and have some financial impact on, the bore owner.

Some causes of reduced bore performance are:

- bio-fouling or clogging
- silt/clay infiltration
- chemical encrustation
- reduction in water table
- well structural failure
- water entry problems.

Monitoring

Many bores and pumps fail because they are either not maintained properly or because gradual changes go unnoticed.

Knowing the physical condition of the bore is rarely enough to be able to select the most appropriate curative or preventative action. However, long-term monitoring of bore performance can assist in the early identification of any decline in performance.

Monitoring the:

- standing water level
- discharge volume
- power usage
- water quality

can help to identify the cause of the problem.

The structural integrity of the bore should be checked to identify any signs of bore component failure. Techniques may include:

- geophysical logging
- dye testing
- using a down-hole camera.

It is essential that the casing condition be thoroughly examined and any deterioration, damage, or holes be accurately located and assessed.

Local knowledge is also valuable to assist with problem-solving, as other bores may have experienced similar issues.

With this information the bore owner is able to better understand if the bore requires maintenance or rehabilitation.

Maintenance tasks will not result in changes to the physical structure of the bore.

Rehabilitation may change the structure of the bore. As a result, bore rehabilitation should be performed only by a licensed driller, and a bore permit is required to undertake this work.

Bore Maintenance

As water bores are drilled in different types of formations and to different depths, some bores will require more maintenance than others.

In certain groundwater environments, encrustations or blockages of various types can occur on bore casings, screens, in gravel packs, and in pumps. These blockages must be removed to return the bore to optimum performance.

A number of common physical and chemical repair methods are available and provide effective solutions for common bore performance problems.

These methods include:

- airlifting, jetting, and surging
- bailing, surging, and swabbing
- brushing
- ultrasonic treatment
- chemical treatment
- use of detergents.

Chemicals are generally used in conjunction with mechanical actions to break up or dissolve any encrustation or blockages.

Table 17.1 shows various chemicals used in the treatment of bores and the types of problems they target. A number of proprietary products have been developed specifically to treat bores. They often contain one or more of the listed chemicals, although the particular formulation is often not published.

Table 17.1 Chemicals used in the treatment of bores

Chemical	Use
Chlorine (derived from calcium hypochlorite or sodium hypochlorite) Hydrogen peroxide Copper sulphate Potassium permanganate	Disinfectant
Acid (hydrochloric, phosphoric, sulphamic)	Scale/encrustation removal
Polyphosphates Sodium hexametaphosphate (Calgon)	Dispersing agent for treating clay
Proprietary products* (usually acid-based with a disinfectant)	A number of products are available that target all of the above

NOTE

- * Proprietary products usually incorporate an inhibiting agent to lower corrosiveness and a wetting agent to assist infiltration of chemicals.

Rehabilitation

Structural mechanical repair methods for the rehabilitation of bores can present many more problems than drilling a replacement bore. In part, this is because of uncertainties about the condition of the existing casing and bore construction history, including cost and variations in materials used.

In many instances the loss of capability from the bore because of reduction in casing size is preferable to decommissioning the bore and drilling a replacement.

Rehabilitation of bores can include:

- relining the bore with a new casing
- in situ repairs
- repairing the screens
- removing and replacing the casing
- sealing a zone.

Relining is an option for structurally weak bores where large sections of casing or screen have failed.

In situ repairs are best attempted when isolated sections of the casing or screen require repair. This can be achieved by swaging a patch across the affected area. In situ repairs are less intrusive than other methods of mechanical repair of casing, such as relining, and generally do not have a major effect on the overall diameter of the casing.

Retrieve and replace techniques are generally not used because of the risk of borehole collapse after retrieval, or the casing parting on removal.

Particular care is required when grout sealing rehabilitated bores. Sealing pressures can exert additional pressure on old casing, causing further problems.

Mandatory Requirements

- 17.1 *The rehabilitation of any bore shall be carried out in accordance with state or territory requirements.*
- 17.2 *The standards set down for constructing new water bores also apply to the rehabilitation of existing water bores.*

Good Industry Practice

- 17.3 *Before any work is done, a thorough check for any historical information about the bore should be carried out. Details of all known related bores should also be researched.*
Every effort should be made to identify the problem, because much time and money can be wasted on work that does not target the actual cause.
- 17.4 *If the presence of iron bacteria is suspected (but not obvious), a water analysis should be carried out to determine the level of infestation.*
Before chemically treating a bore, it is wise to determine the nature and cause of the problem in the first place, as this will allow the specific problem to be targeted and the appropriate treatment to be carried out.
- 17.5 *It is good practice to measure the pH and conductivity of the water before any treatment is commenced. When treatment is complete, the quality of the discharge water should be tested and should be similar to that tested before treatment.*
The pH should be within 0.5 units and conductivity within 10 per cent of pretreatment readings before the supply is reconnected to the reticulation system. This will ensure that there is little or no residual chemical remaining in the bore on completion of the work.
- 17.6 *During treatment, the supply should be disconnected from the reticulation system to ensure that water is not available for consumption.*
Remember, treating a bore with the incorrect chemical is a waste of time and money. For example, using a disinfecting agent to treat an encrustation will not result in any improvement in the bore's performance.

- 17.7 *During any rehabilitation work, the driller should ensure that the appropriate safety precautions are taken. Chemicals should be used only by experienced personnel, particularly where no directions are provided for use in water bores.*
- 17.8 *All discharged waste water should be disposed of in a manner that will not affect the environment or existing users.*
- 17.9 *The structural integrity of the casing and the condition of the production interval should be monitored regularly to ensure that any early warning signs of problems that may affect bore performance are detected.*
- 17.10 *Accurate costing of structural mechanical repairs is very difficult as there can be a number of unpredictable and unplanned factors to take into consideration.*
Landholders should always be aware of this fact from the outset, and if work proceeds should be advised about any problems arising and additional costs.
- 17.11 *The owner of the bore should keep records of its performance during its life. This will provide an ongoing record for future reference and will be helpful if rehabilitation is ever required.*
- 17.12 *When rehabilitating bores it is also acceptable to have a minimum 10 mm thickness of cement grout sheathing the pump housing casing where the pump housing casing is constructed of inert material such as plastic.*
Such pump wells are to be limited to a maximum depth of 60 metres below either:
- the calculated static head at the time of reconditioning for an artesian bore*
 - or*
 - the standing water level at the time of reconditioning in a sub-artesian bore.*
- 17.13 *The production casing below the pump housing casing should have a minimum 15 mm thickness of cement grout sheathing it.*

This page is intentionally blank.

18. Bore Decommissioning

Principle:

Failed or unwanted bores should be decommissioned to restore, as far as possible, the aquifer isolation that existed before the bore was drilled and constructed.

All bores and test holes that are to be decommissioned must be permanently sealed to prevent:

- the entry of any surface fluids and contaminants
- the intermixing of fluids and pressures between aquifers
- injury and harm to people and animals.

Reasons for decommissioning a bore include:

- they are no longer required
- they are no longer suitable for clients' needs
- the casing has deteriorated, leading to poor casing integrity
- they are unsealed abandoned test holes
- there is uncontrolled flow.

Failed bores constitute a potential hazard to public health and safety, and to the preservation of the quantity and quality of the groundwater resource.

The following matters should be considered when decommissioning a bore:

- the construction of the bore
- geological formations encountered
- hydrogeological conditions
- regulatory requirements.

To decommission a water bore, several requirements must be met. These include:

- eliminating any physical hazard (e.g. filling in open holes)
- preventing groundwater contamination
- conserving yield and maintaining hydrostatic head of aquifers
- preventing waters intermixing.

Decommissioning by fully grouting from the top to the bottom is the preferred method for all bores.

Figures 18.1, 18.2, 18.3, and 18.4 show the arrangements that should be used to decommission the most common types of bores and/or holes.

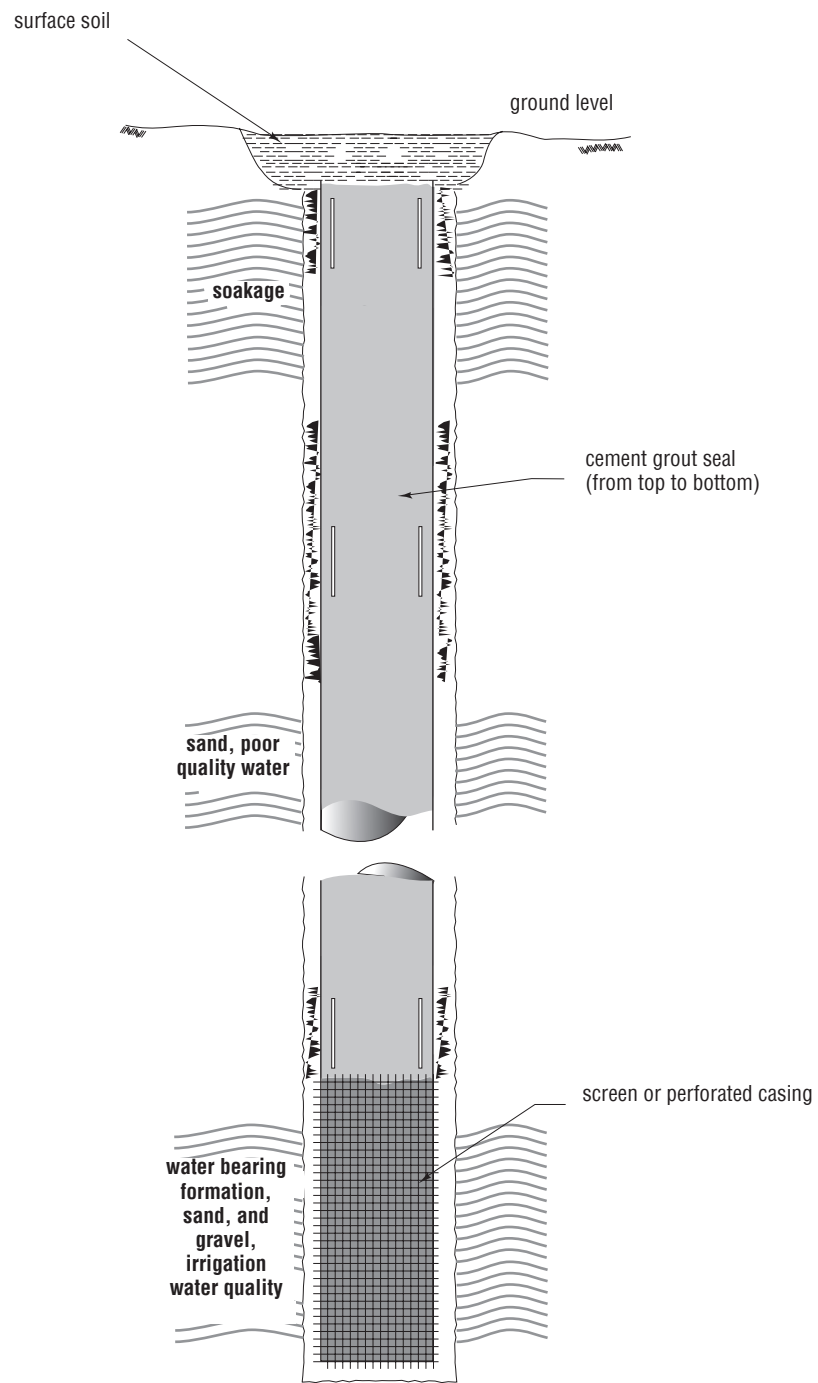

Figure 18.1 Decommissioning a non-flowing bore by fully grouting (preferred method for all bores)

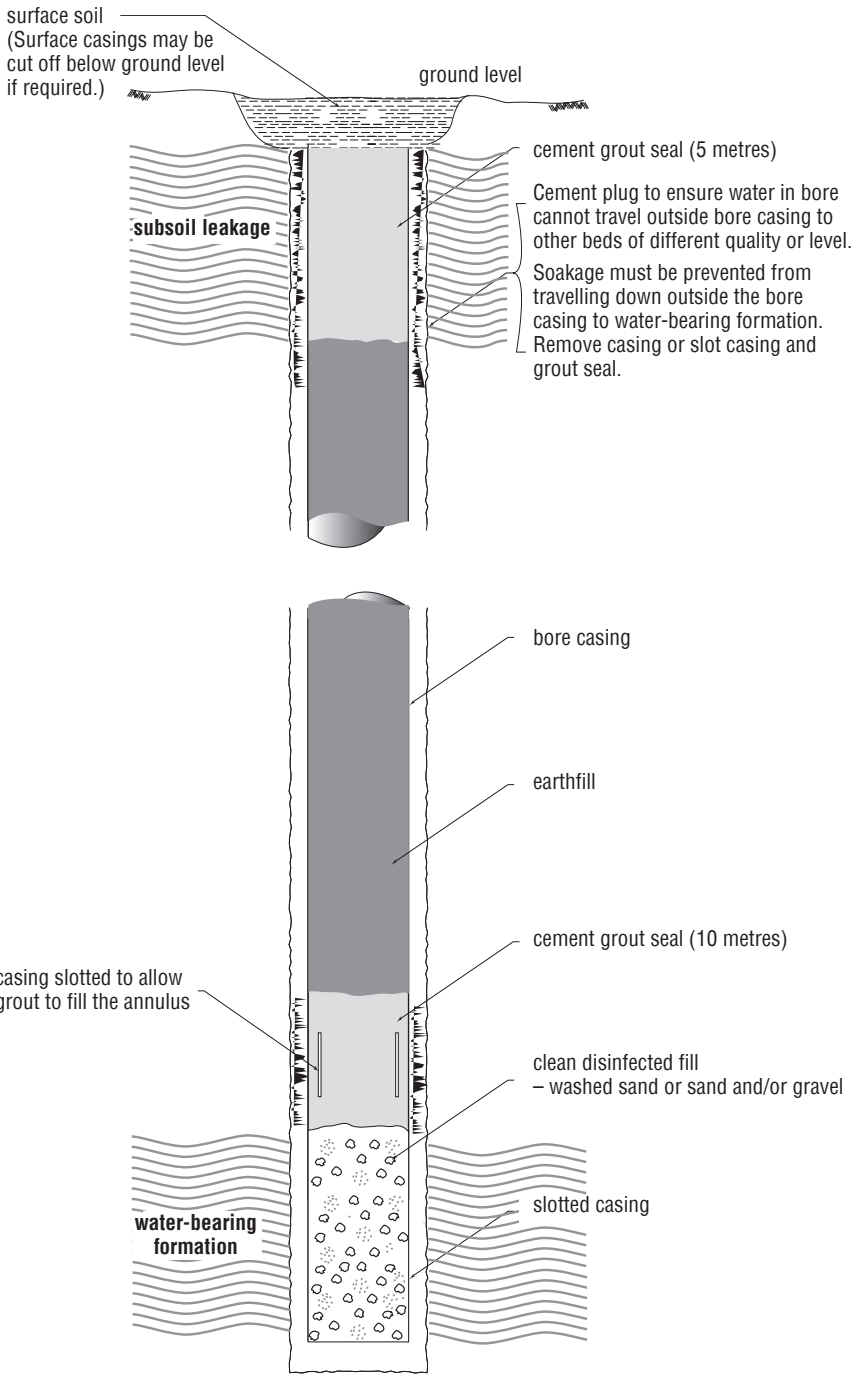

Figure 18.2 Decommissioning a single aquifer non-flowing bore

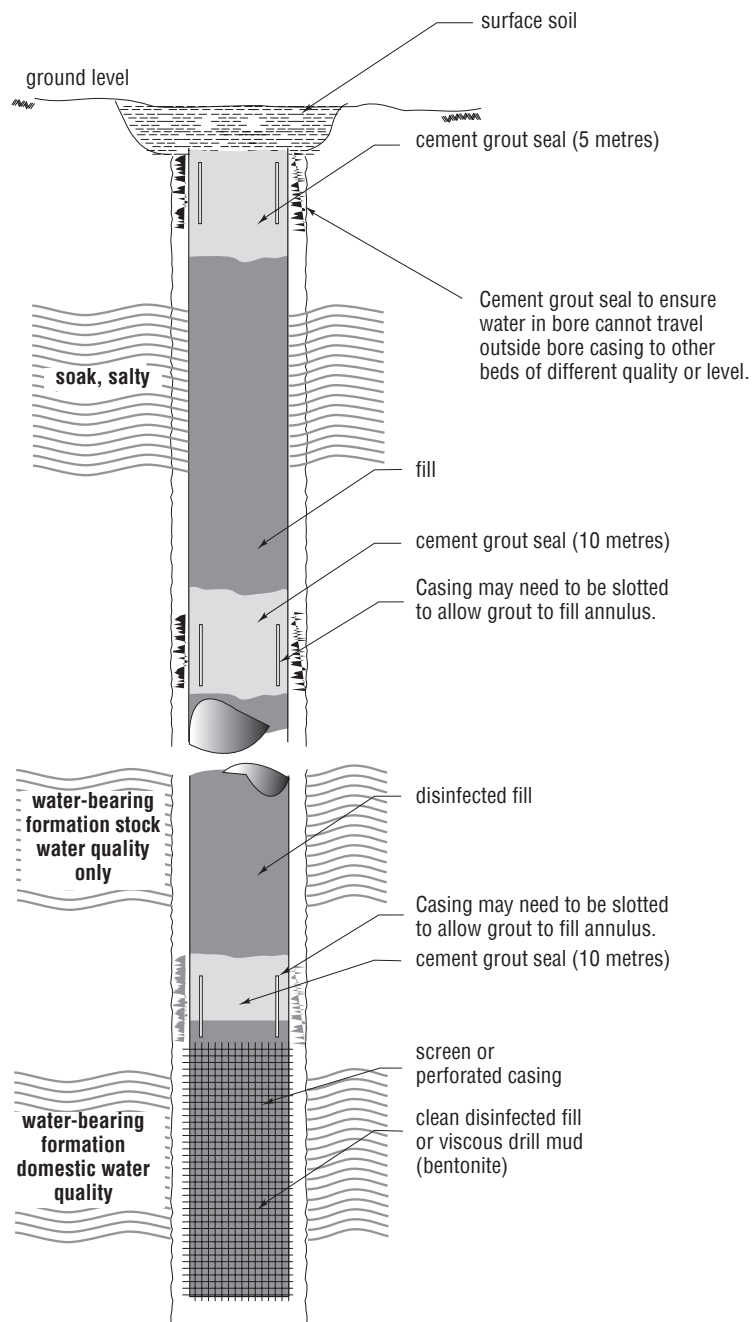

Figure 18.3 Decommissioning a multiple aquifer non-flowing bore using cement grout bridges

Note:

Surface casings may be cut off below ground level if required.

Any possible flow inside or outside the casings between water-bearing formations of different quality or pressure must be prevented.

In some bores the annulus may already have been cemented.

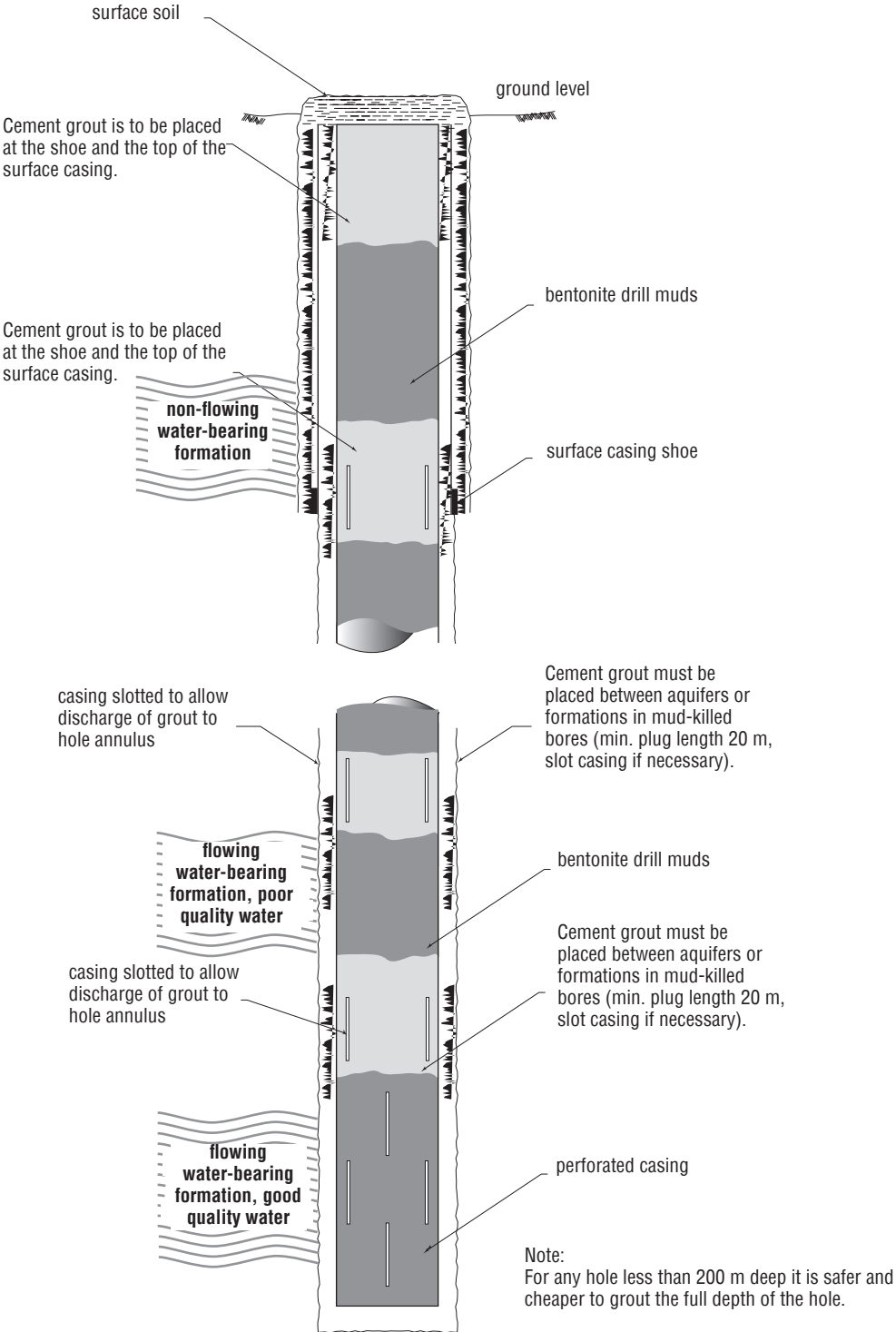

Figure 18.4 Decommissioning a flowing bore using cement grout bridges

Note:
 Surface casings may be cut off below ground level if required.
 Flow to be stopped by pumping a column of dense barites – bentonite mud – or cement grout into bore.
 Any possible flow inside or outside the casings between water-bearing formations of different quality or pressure must be prevented.

Mandatory Requirements

18.1 *Any bore or hole that is to be permanently decommissioned shall be sealed and filled in such a manner to prevent vertical movement of water in the bore, including water in the annular space surrounding the casing.*

The water should be permanently confined to the specific zone in which it originally occurred.

To ensure all penetrated aquifers are protected, all test holes, decommissioned water bores, and wells shall be sealed.

All test holes and test bores shall:

- *be decommissioned by grout sealing as though they were a water bore, as soon as possible but no longer than 10 business days after commencing drilling*

OR

- *comply with the mandatory construction requirements for water bores.*

Supervision of this work by the relevant water authority may be required in some areas.

18.2 *The sealing material shall consist of one or more of the following:*

- *grout*
- *bentonite grout*
- *bentonite pellets/chips*
- *concrete.*

Sealing materials shall be placed to avoid segregation or dilution of material and unnecessary contamination of the aquifer zone.

The sealing material shall not pose any potential health risk.

18.3 *Fill material shall consist of uncontaminated sand, coarse stone, clay, or drill cuttings.*

18.4 *The seals shall be set in impermeable strata immediately above and below each aquifer formation in the bore.*

For non-flowing bores, a minimum of 10 metres of grout plug shall be set for a seal.

18.5 *For flowing bores the length of grout seal shall be:*

- *sufficient to overcome the pressure and stop the discharge of groundwater*
- *not less than 20 metres unless the flow originates from less than 20 metres below the surface.*

See Chapter 15 for more information about recording and reporting data.

18.6 Complete and accurate records shall be kept of the entire decommissioning procedure and supplied to the state or territory water authority.

18.7 Regardless of the decommissioning method used, a concrete or grout surface seal to a minimum depth of 5 metres shall be installed in all decommissioned bores and/or holes.

Where a native soil topping is required, the surface seal should be installed to 1.0 m below the surface, and the soil topping should be compacted and mounded to prevent ponding of surface water above the decommissioned bore.

18.8 For multi-port monitoring bores aquifer isolation must be maintained at all times during operation.

Decommissioning must take place within 7 working days of the removal of the isolation packers.

Good Industry Practice

18.9 Although it is preferable to fully grout bores, bridges may be used in bores where complete grouting is not practicable.

It is often cheaper to completely grout a seal in a hole than to construct bridges within the hole.

18.10 Care should be taken when installing more than one cement plug that existing previously placed cement plugs do not move.

A sample can be taken to check that previous plugs have taken an initial set.

18.12 In order to seal behind the casing, consideration should be given to perforating the casing to allow cement grouting to occur. This is to prevent flow occurring behind the casing.

18.13 Water bores and monitoring bores are covered by the Minimum Construction Requirements for Water Bores in Australia.

All other holes, irrespective of their purpose, should be decommissioned in accordance with this document. This should occur as soon as practicable when the purpose of the hole is complete in order to protect the groundwater resource.

This is designed to prevent the intermixing or contamination of groundwater.



Running casing into the hole
Photo courtesy of Kangarilla Drilling Pty Ltd.

A. Acronyms and Definitions

The following definitions may be useful in understanding this book.

ABS Acrylonitrile Butadiene Styrene, a composite material used for bore casing.

Air line A small-diameter pipe installed in the bore and charged with air for the purpose of measuring the water level.

Alignment The horizontal deviation between the actual bore centre line and a straight line representing the ideal centre line.

Annular space The ring-like space between the bore casing and the outer bore casing or borehole.

Aquifer A geological formation, group of formations, or part of a formation, capable of transmitting and yielding quantities of water.

Aquitard aquiclude see Confined groundwater.

Artesian bore A bore in an aquifer where the groundwater is confined under pressure, so that the water level in the bore will rise above the top of the aquifer and ground level (a flowing bore).

Bailer A tube made from pipe with a valve in the bottom, used to remove cuttings or sediments from the hole.

Bore (well) A hole sunk into the ground and completed for the abstraction of water or for water observation purposes.

Bore completion report The report required to be submitted by state and territory regulatory authorities on completion of bore construction. (Also known, for example, as Drill Log, Form A.)

Bore construction permit (Bore permit) An authority issued by a state or territory regulator to construct a bore on a specified location. This document that lists state or territory legislative requirements, authorises construction, and outlines conditions for bore construction, alterations, and decommissioning.

Cake thickness see Wall cake thickness.

Casing A tube used as a temporary or permanent lining for a bore.

Surface casing The pipe initially inserted into the top of the hole, to prevent washouts and the erosion of softer materials during subsequent drilling. Surface casing is usually grouted in, and may be composed of steel, PVC-U, or composites such as ABS or FRP. For flowing bores the surface casing needs to be grouted into a competent formation to control subsurface pressures.

Production casing A continuous string of pipe (casing) that is inserted into or immediately above the chosen aquifer (see Production zone) and back to the surface, through which water is extracted or injected.

Cement grout A fluid mixture of Portland cement and water of a consistency that can be forced through a pipe and placed as required.

- Cementing** The process of placing a grout into an annular space to provide a permanent seal. Also refers to the method often used to stabilise a lost circulation zone or a cavity.
In this book this process is referred to as 'grouting'.
- Centraliser** A tool used to centre the casing in the hole.
- Client** The party entering into a contract or agreement for the purchase of any materials or work to be performed in accordance with the provisions of this publication. A client may or may not be the owner.
- Conditioning** Agitating the borehole while circulating the drilling fluid to help remove cuttings and other unwanted material.
- Confined groundwater** A completely saturated aquifer in which the upper and lower boundaries are relatively impermeable layers (aquitards or aquicludes).
The groundwater is contained under sufficient pressure to cause it to rise above the aquifer if the top of the impermeable layer is breached.
- Confining bed** A layer of relatively impermeable material underlying, overlying, or adjacent to, one or more aquifers.
- Consolidated formation** Hard rock-material strata of sedimentary-igneous, or a metamorphic-type rock, which can be porous and permeable to provide an aquifer.
- Construction** The entire process of creating a bore, from initial drilling and inserting the surface casing through to insertion of a screen and developing the aquifer prior to installing a pump.
- Contractor** The party that enters into a contract or agreement with the client to furnish the work and materials according to the provisions of this publication.
- Decommissioned bore** A bore, the purpose and use of which have been permanently discontinued.
- Development** The removal of sand and other fines (including drilling mud) from the aquifer immediately surrounding the bore and creating a filter zone around the bore that prevents further movement of aquifer particles into the bore.
- Discharge** The volume of water pumped or flowing from a bore per unit of time, expressed in litres per second.
- Drawdown** The difference between the observed water level during pumping and the water level before pumping commenced.
- Drill log** see Bore completion report.
- Driller** A licensed water bore driller who is ultimately responsible for the work being carried out.

- Drilling fluid** A medium used to stabilise the formation, control groundwater, and remove the drill cuttings from the hole as drilling takes place.
- Drilling operations** The drilling, construction, development, maintenance and rehabilitation, and decommissioning of a bore.
- Effective size** The sieve-size opening that will pass 10 per cent of a representative sample of the filter material.
For example, if the size distribution of the particles is such that 10 per cent of a sample is finer than 0.45 mm, the filter material has an effective size of 0.45 mm.
- EPA** (Environmental Protection Authority) A representative term for government departments and agencies responsible for environmental management.
- Fill** Material consisting of uncontaminated sand, coarse stone, clay, or drill cuttings.
- Filter pack** see Gravel pack.
- Filtration properties** Ability of the drilling fluid to form a controlled filter cake on the wall of the hole under virtually static conditions.
- Flowing bore** A bore from which groundwater is discharged at the ground surface without the aid of pumping.
- Formation** A bed or deposit composed throughout of substantially the same kind of rock; a lithologic unit. Each different formation is given a name.
- Formation pressure (Head)** Energy contained in a water mass, produced by elevation, pressure, or velocity.
- FRE** Fibreglass-reinforced epoxy — a composite material composed of glass fibres and epoxy resin.
- FRP** Fibreglass-reinforced plastic — a composite used for bore casing or riser pipe that is inert to most naturally occurring substances.
- GAB** Great Artesian Basin.
- Good Industry Practice** The preferred methods that are commonly used to achieve acceptable results. They are used extensively by the majority of drilling contractors.
- Gravel pack** Granular material introduced into the annulus between the borehole and a casing or perforated lining to prevent or control the movement of finer particles from the aquifer into the bore.
- Groundwater** (Underground water) Water that is held in the ground.

Grout A fluid mixture of cement and water of a consistency that can be pumped through a pipe, to which other additives (e.g. bentonite) may be added to enhance its properties.

Sometimes called 'cement grout' or 'cement slurry'.

Grouting The operation of placing or pumping a grout into an annular space or cavity.

Head see Formation pressure.

Headworks An assembly bolted to the production casing to control the well, to provide access and protection (e.g. from flooding, vandalism).

Hydrogeological properties The properties of formations that control the movement and storage of groundwater (e.g. hydraulic conductivity, storativity, transmissivity, and permeability).

Licensed A requirement that drillers shall possess a certain class of licence in order to construct the bore.

Liner A casing, screen, or other device inserted into a larger casing, screen, or open hole as a means of sealing off undesirable material or maintaining the structural integrity of the well.

Mandatory Requirements Enforceable by regulators (through legislation) designed to protect groundwater resources.

Mandatory Requirements shall be adhered to during all phases of construction of a bore.

Monitoring bore A bore constructed solely to obtain hydrological or water-quality data.

Mud cake thickness see Wall cake thickness.

Nominal diameter An approximate diameter (internal or external) of the tube, usually used for simple identification purposes. For example, a 100 mm diameter tube may vary within a manufacturing range of 99.5 mm and 100.5 mm.

On site A general rule that requires a licensed driller to be in control of all the various phases throughout the construction of a bore.

Perched water Unconfined groundwater separated from an underlying body of groundwater by an unsaturated zone and supported by an aquitard or aquiclude.

Perforations A series of openings in a bore casing.

Permeability The capacity of a porous medium for transmitting water.

Permit see Bore permit.

pH Index of acidity or alkalinity of water.

Piezometer A pipe in which the elevation of the water level or potentiometric surface can be determined. The pipe is sealed along its length and open to water flow at the bottom.

- PN (pipe nominal)** The nominal pressure rating of the pipe.
- Plumbness** The horizontal deviation (drift) of the bore centre line from true vertical.
- Production zone** The zone within the target formation that produces the water supply requirements for the bore.
- Pumping level** The water level in the bore when pumping is in progress.
- PVC-U** Unplasticised polyvinyl chloride.
- Reconditioning** Restoring a bore by a variety of chemical or mechanical means that do not involve replacing or modifying any of the original materials used to construct the bore.
- Recovery** The difference between the observed water level during the recovery period after cessation of pumping and the water level measured immediately before pumping stopped.
- Regulator** A state or territory water licensing authority.
- Rehabilitation** The restoration of a bore to its most efficient condition using a variety of chemical or mechanical techniques, which may include replacing the production casing and/or screens.
A driller shall be licensed in order to carry out rehabilitation of a bore.
- Screen** A special form of bore liner used to stabilise the aquifer or gravel pack while allowing the flow of water through the bore into the casing and permitting development of the screened formation by an appropriate process.
- Shoe** An extension fitted to the end of the casing, commonly a drive shoe (for advancing the casing) or a float shoe (used for grouting).
- Sonic Drilling** A continuous core drilling method that uses vibrosonic energy to pulverise drilled material and push it outwards from the borehole. This permits the hole to be advanced without requiring a drilling fluid to remove cuttings back to the surface.
Commonly used for environmental investigation.
- Sorted (well/poorly)** A measure of the uniformity of grain sizes.
- Spear point** Generally a shallow bore drilled by simple methods (self-jetted, lowered in augured holes or driven) in unconsolidated sediments for groundwater extraction.
- Specific capacity** The ratio of the discharge to the drawdown it produces, measured inside the bore (L/min/m of drawdown).
- Specific gravity** The weight of a given volume of material compared to the weight of an equal volume of water at a reference temperature under standard conditions.
- Standing water level** The level of groundwater standing in a bore uninfluenced by pumping in that bore.

Static head The height, relative to an arbitrary reference level, of a column of water that can be supported by the static pressure of the aquifer at a given point.

Target formation The intended geological formation or production zone.

Telescoping A method of fitting or placing one casing inside another or introducing a screen through a casing diameter larger than the diameter of the screen.

Test bore Completed bore for pumping to obtain information on capacity, groundwater quality, geological and hydrological conditions, and related information.

Test hole A hole used only to obtain information on groundwater quality and/or geological and hydrological conditions.

Threaded PVC A type of PVC that has male and female threads on each end that gives a flush inside and outside joint, avoiding the need for solvents.

A sealastic or flexible sealant is recommended to ensure the joints are watertight. The use of solvents for this purpose is not recommended.

Total dissolved salt The quantity of dissolved salts in a sample of water, expressed as mg/L.

Transmissivity The rate at which water of the prevailing kinematic viscosity is transmitted through a unit width of an aquifer under a unit hydraulic gradient, expressed in square metres per day.

NOTE: Transmissivity is equal to the hydraulic conductivity multiplied by the thickness of the aquifer.

Tremie pipe A device or small-diameter pipe that carries materials to a designated depth in the hole.

Unconfined aquifer An aquifer in which the upper boundary of the saturated zone is at atmospheric pressure.

Unconsolidated formation Loose, soft rock-material strata of sedimentary, igneous, or metamorphic-type rock, which includes sand, gravel, and mixtures of sand and gravel.

These formations are widely distributed and can possess good storage and water transmissivity characteristics.

Underground water see Groundwater

Wall cake A low permeability film that is deposited on the porous face of the borehole by the drilling fluid to prevent fluid loss (the ability to deposit this film is a principal requirement of the drilling fluid).

Wall cake thickness The thickness of the wall cake that has been deposited on the porous face of the borehole by the drilling fluid.

Water-bearing formation A formation capable of storing and transporting water.

Water table The surface of saturation in an unconfined aquifer at which the pressure of the water is equal to that of the atmosphere.

Well see Bore.

B. Resources

Relevant sections of this book should be read with reference to the following **Australian Standards**:

AS 1141.11.1 *Methods for Sampling and Testing Aggregates*

AS 1396 *Steel Water Bore Casing*

AS/NZS 1477 *Unplasticised PVC (PVC-U) Pipes and Fittings for Pressure Applications*

AS 1579 *Arc Welded Steel Pipes and Fittings for Water and Wastewater*

AS 2368 *Test Pumping of Water Wells*

AS 3518.1 *Acrylonitrile Butadiene Styrene (ABS) Pipes and Fittings for Pressure Applications — Pipes*

AS/NZS 3879 *Solvent Cements and Priming Fluids for Use with Unplasticised PVC (PVC-U) Pipes and Fittings*

AS 3972 *Portland and Blended Cements*

Training courses to develop skills for

- screening and gravel packing bores
- drilling fluid techniques and testing
- cement grouting

are conducted on a regular basis across Australia by

Australian Drilling Industry Association

PO Box 3020

Frankston East Vic. 3194

telephone: (03) 9770 4000 facsimile: (03) 9770 4030

website: www.adia.net.au

and

Australian Drilling Industry Training Committee

PO Box 742

Lane Cove NSW 2066

telephone: (02) 9428 3444 facsimile: (02) 9428 3555

website: www.aditc.com.au

More information on drilling methods and applications, and on the design and construction of water bores, is in the following industry publications.

Drilling – The Manual of Methods, Applications and Management

Available from:

Australian Drilling Industry Association
PO Box 3020
Frankston East Vic. 3194
telephone: (03) 9770 4000 facsimile: (03) 9770 4030

Australian Drilling Industry Training Committee
PO Box 742
Lane Cove NSW 2066
telephone: (02) 9428 3444 facsimile: (02) 9428 3555

Johnson's Groundwater and Wells

Available from:

Australian Drilling Industry Association
PO Box 3020
Frankston East Vic. 3194
telephone: (03) 9770 4000 facsimile: (03) 9770 4030

Johnson Screens
PO Box 85
Virginia Mail Centre Qld 4014
telephone: (07) 3867 5555 facsimile: (07) 3265 2768

C. Typical Bore Types

Common Bore Designs

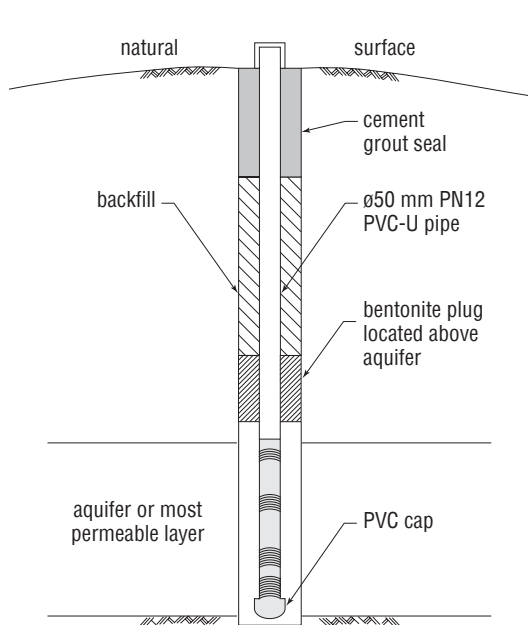

Figure C1 Monitoring bore with bentonite seal and backfill to surface

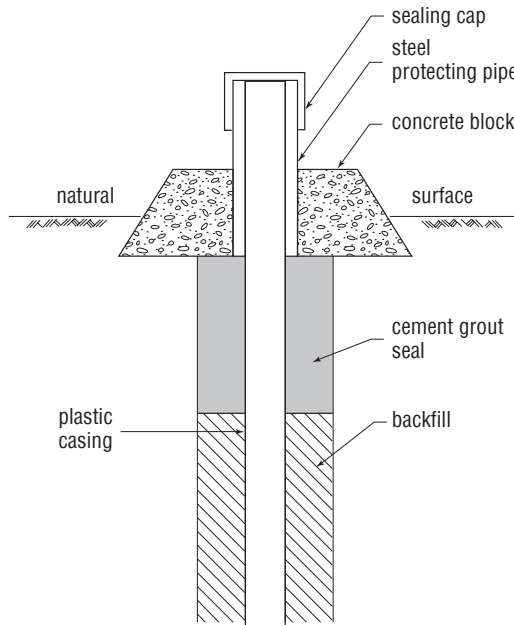

Figure C2 Permanent headworks for non-flowing bore with concrete pad and steel protecting pipe

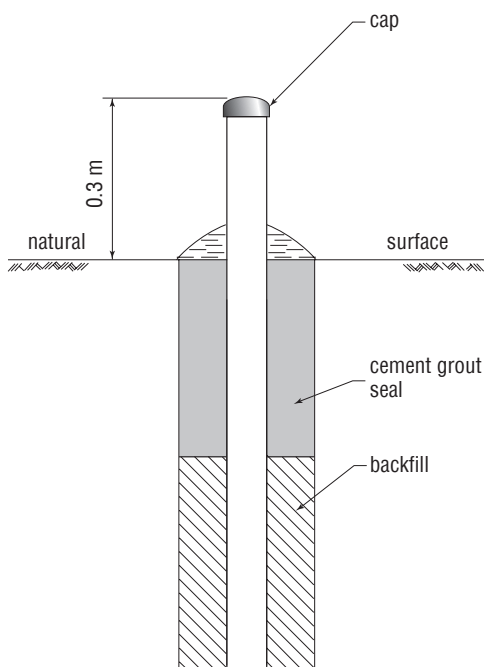

Figure C3 Temporary headworks for non-flowing bore

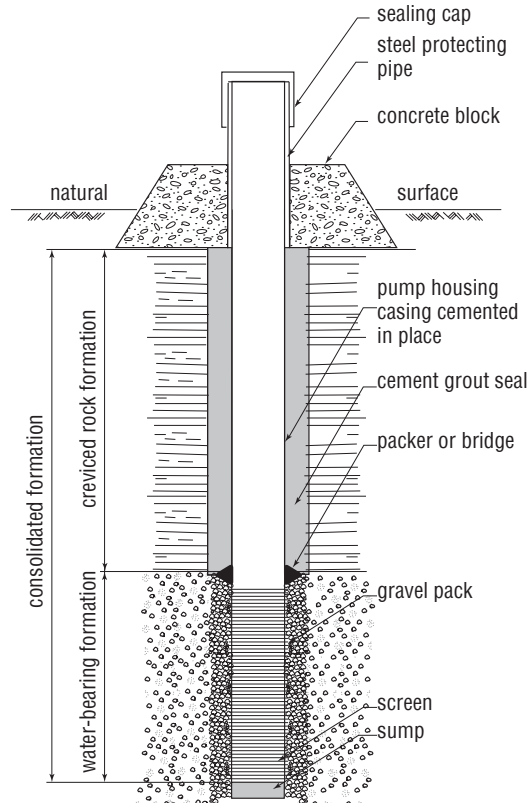

Figure C4 Permanent headworks completion of a non-flowing monitoring bore

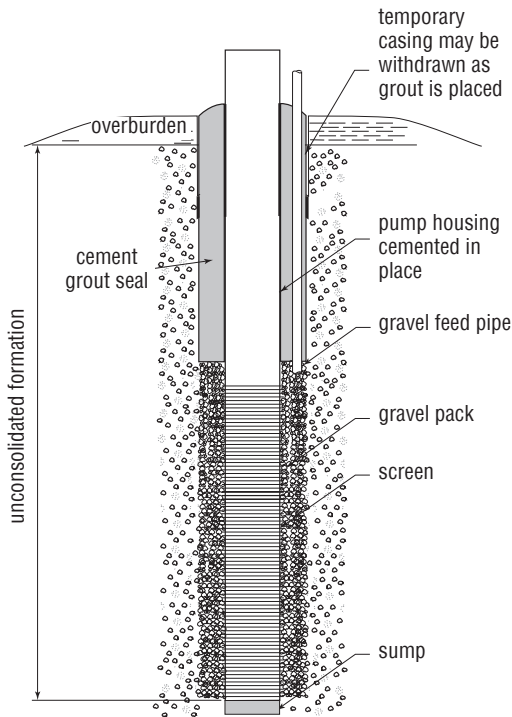

Figure C5 Gravel-packed bore with casing cemented in place and gravel pack terminated above top of the screen with gravel feed pipe

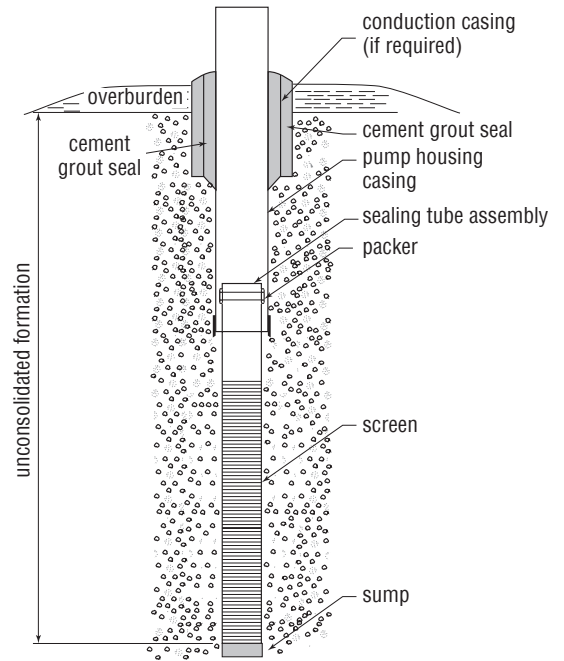

Figure C6 Naturally developed bore with telescopic screen, pump housing casing driven or jacked into place, and the conductor sealed

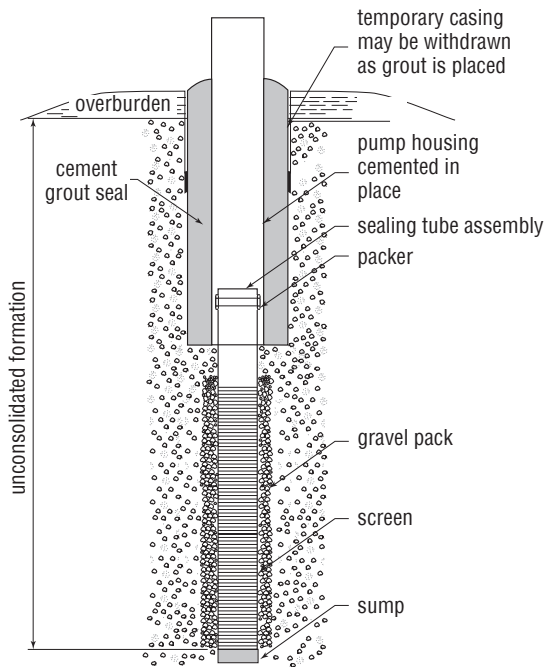

Figure C7 Gravel-packed bore with telescopic screen, casing cemented in place

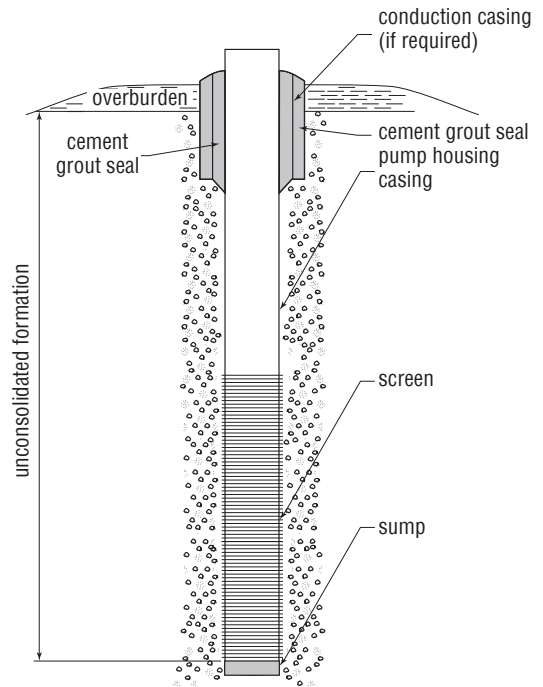

Figure C8 Naturally developed bore with inline screens

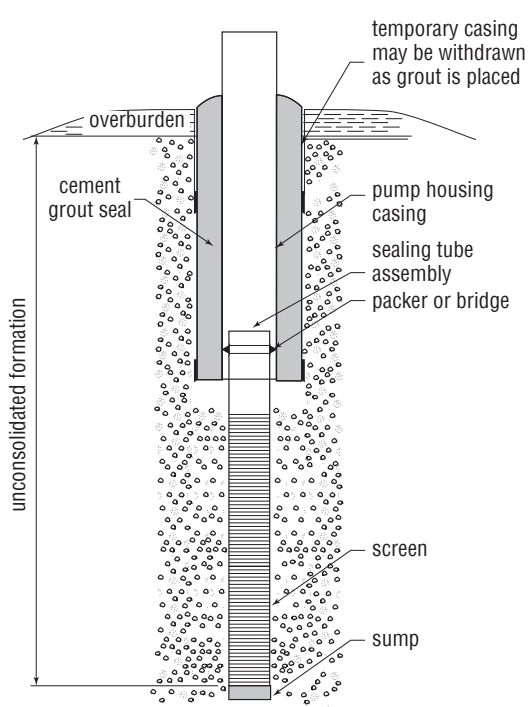

Figure C9 Naturally developed bore with telescopic screen, temporary casing driven or jacked into place, and the pump housing casing sealed to prevent contamination

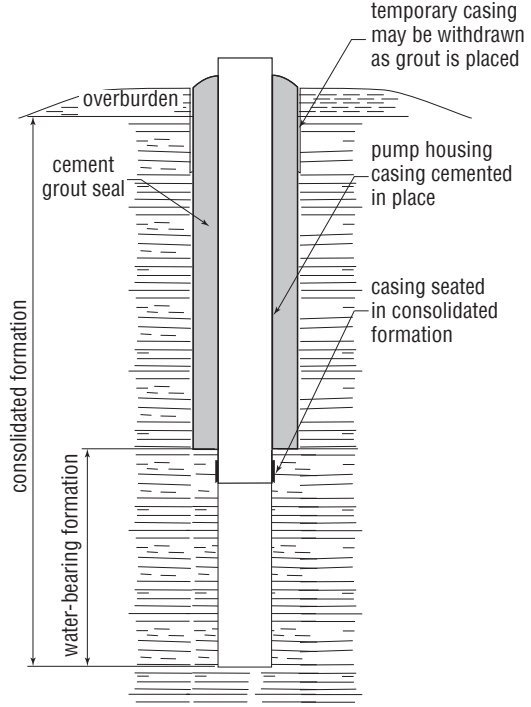

Figure C10 Bore with open hole completed in consolidated formation

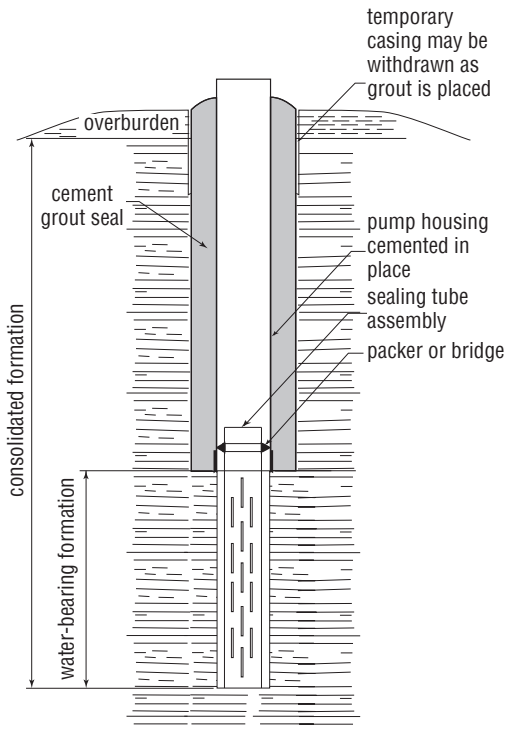

Figure C11 Bore with telescopic slotted casing liner completed in consolidated formation

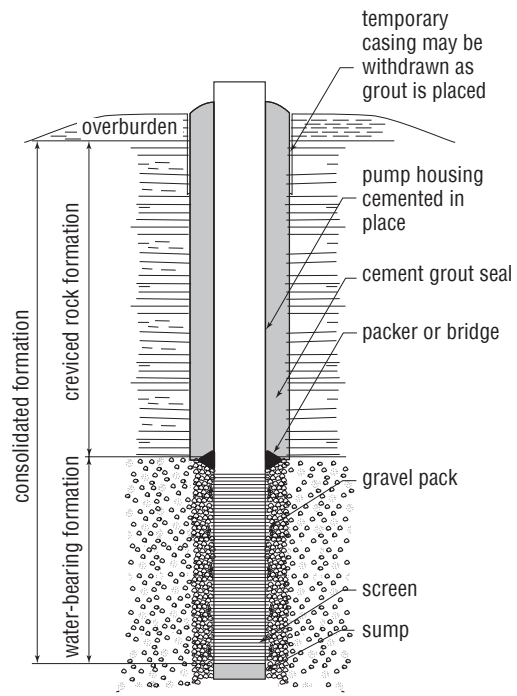

Figure C12 Gravel-packed bore completed in consolidated formation, with casing cemented in place

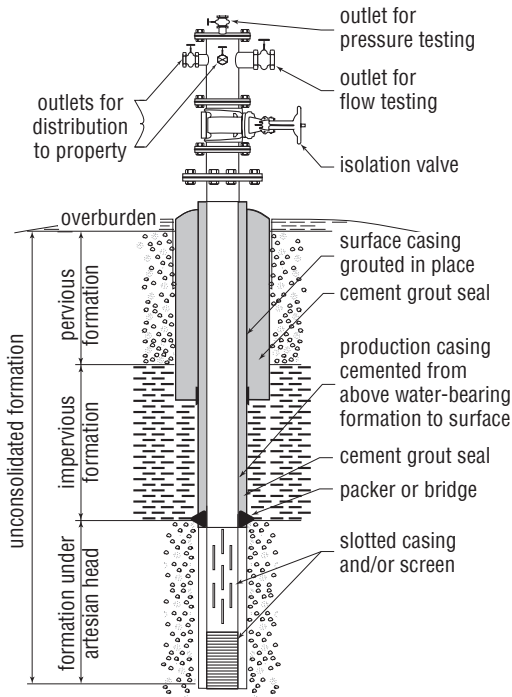

Figure C13 Slotted casing or screened bore completion in an artesian aquifer, where the piezometric level is above the ground elevation

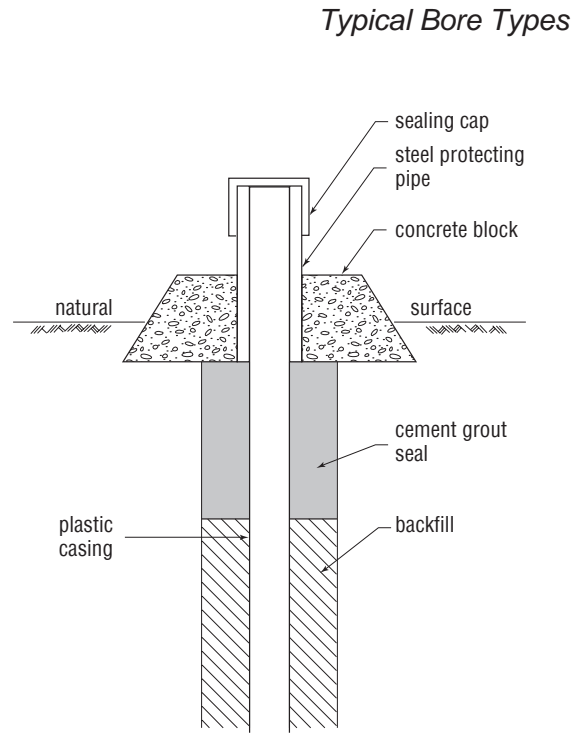

Figure C14 Permanent headworks for non-flowing bore with concrete pad and steel protecting pipe

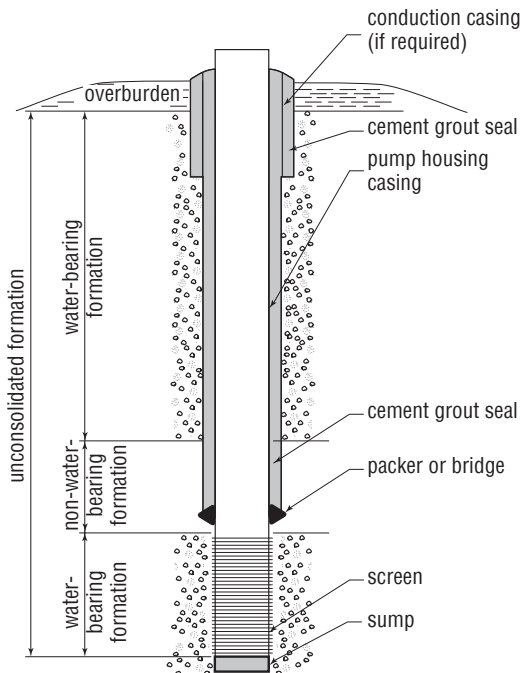

Figure C15 Naturally developed non-flowing bore in unconsolidated formation, where the hydraulic properties of the formations are different and need permanent separation

Decommissioned Bore

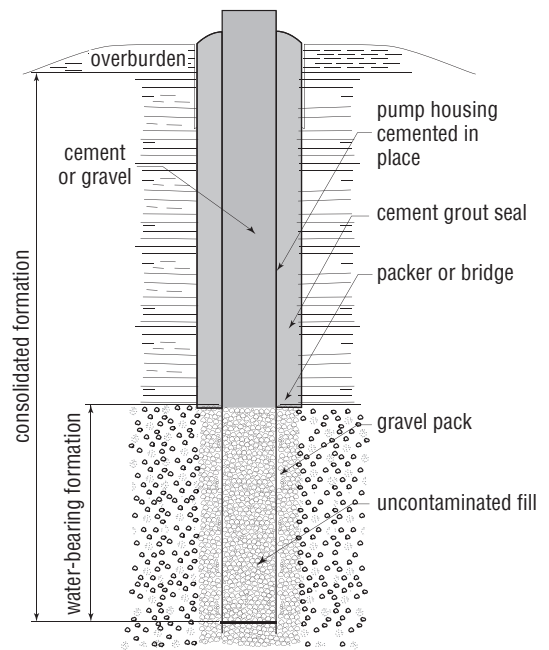

Figure C16 Decommissioned non-flowing bore

D. Sample Contract Documentation

WATER BORE AGREEMENT

THIS AGREEMENT is made the day of Two thousand and
between
of
[“the Principal”] of the first part and
.....
of
[“the Drilling Contractor”] of the second part.

Whereas:

A. The Property

The Principal is the registered proprietor/ lessee/ occupier of the property situated at
..... [“the property”]

B. Bore Permit Number

The Principal has requested that the Drilling Contractor carry out the drilling works as detailed herein [“the works”] at the property under Bore Permit / License Number / without a Bore Permit.

THIS AGREEMENT NOW WITNESSES THAT EACH PART AGREES AS FOLLOWS:

1. Interpretation

- 1.1 In this Agreement unless the context otherwise requires the singular includes the plural and vice versa, and any gender includes any other genders and words denoting persons shall include bodies corporate and vice versa.
- 1.2 Headings to articles, clauses and sub-clauses are inserted for convenience only and shall not form part of this Agreement nor affect its construction and references to articles, clauses and sub-clauses shall be references to articles, clauses and sub-clauses of this Agreement unless otherwise indicated.
- 1.3 The Commencement Date shall be the date upon which drilling works commence.

2. Duties of the Principal

The Principal shall at a reasonable time prior to the Commencement Date:

2.1 Access

Provide good and safe access to the property and to each drilling site [“each site”].

2.2 Firebreaks

Ensure that all necessary firebreaks have been provided at near and/or in the vicinity of each site.

2.3 Permits etc.

Obtain and comply with all municipal shire and governmental permits or licenses and any other requirements at law, including any statutory obligations, in relation to the works, except for those specified herein to be the responsibility of the Drilling Contractor

2.4 Survey Plans

Provide to and check for the benefit of the Drilling Contractor all survey plans and other data relating to underground services at, near and/ or in the vicinity of each site.

2.5 Site Hazards

Provide all information necessary for the Drilling Contractor to assess any hazards, both actual and/or potential, to performing the works which exist or may exist on, within or near each site.

If prior to or during commencement of the works the Drilling Contractor assesses that any drilling site contains any hazard or potential hazard to implementing the works, whether wholly or partly, then all costs and expenses which the Drilling Contractor believes necessary to eliminate or prevent such a hazard shall be an additional expense and shall be borne by the Principal and shall be paid for in like terms to that provided in Clause 2.8 herein.

2.6 Bore Location

Mark each site with a stake, flag or other legally distinguishable method and to provide the Drilling Contractor with a map of the property identifying the position of the proposed bores and ensure that each site is accessible for the Drilling Contractors requirements herein.

The Drilling Contractor shall not be responsible for any error in relation to any bore's location which responsibility at all times vests in the Principal.

2.7 Indemnity

To indemnify the Drilling Contractor for any claims made against the latter arising from or in connection with the works to the extent that any such claim exceeds the sum insured by the Drilling Contractor as provided for and specified in Clause 3.6 herein.

2.8 Payment

Pay the Drilling Contractor for:

[a] Schedule of Rates

2.8.1	Establishment to site	\$	
2.8.2	Drilling of bore	\$	per metre
2.8.3	Supply and delivery and installation of casing and accessories	\$	nominal mm I/D at per metre
2.8.4	[a] Supply and delivery of screens	\$	nominal mm I/D at per metre
	[b] Gravel pack [if required]	\$	
2.8.5	Development including all development work on the bore, testing for alignment etc, removing casing, cementing and reinstatement	\$	per hour
2.8.6	Drilling into rock	\$	per metre

2.8.7	Standby rates where rig and crew are idle due to the orders of the Principal or waiting on sieve analyses and/ or water analyses	\$	per hour
2.8.8	Testing of the bore, including establishment	\$	per hour

OR

[b] Lump Sum Agreement

2.8.1	Make full payment to the Drilling Contractor on the completion of the works the sum of:	\$	
-------	--	----	--

2.9 Terms of Payment

Payment in full shall be due on completion of the works.

OR

Make all payments due to the Drilling Contractor as provided herein not later than thirty [30] days from the date of invoice.

3. Duties of the Drilling Contractor

The Drilling Contractor or his sub-contractors shall , provided that the Principal has fulfilled all his obligations herein described to enable the works to commence:

3.1 Commencement

Commence the works on the day of 20.....

3.2 Depth/ Diameter

Drill at each site designated by the Principal at a nominal diameter of mm, and to a maximum depth of metres.

3.3 Casings/ Screens

Provide and install casing and suitable slotted screen or other screen at a diameter of:

3.3.1	Casing [nominal]mm I/D
3.3.2	Screensmm I/D
3.3.3	Special screensmm I/D

3.4 Development

Carry out development and test each bore in accordance with relevant legislative and/ or regulatory requirements or, but subject to the above as required by the Principal as detailed under Special Conditions of this Agreement

3.5 Alignment

Ensure that the casing shall be round, true to line and free of obstruction.

3.6 Limit of Indemnity

Prior to the commencement of the works and thereafter at his own cost take out and maintain during performance of the works a policy or policies of insurance for any liability arising from or in connection with the works in the sum of \$ such insurance cover thereby including claims arising from the Drilling Contractor's conduct or any injury to the Drilling Contractor's employees or any accident with or damage to the Drilling Contractor's plant or equipment or any other claims usually covered by a policy of insurance taken out by drillers PROVIDED HOWEVER that the liability of the Drilling Contractor shall be limited to the amount specified in such policy of insurance.

3.7 Drilling Licenses/ Permits

Ensure that bore construction is carried out in conformity with all applicable legislation and/ or regulations and if required by such law under the supervision of a duly qualified holder of a Drilling License/ Permit.

4 The Principal and the Drilling Contractor agree:

4.1 Guarantee of Water

The Drilling Contractor does not at the time of nor at any time prior to this Agreement did he represent, warrant or promise to the Principal that with respect to each site water would be located and/ or it would be of a certain quality or quantity AND FURTHER all payments due to the Drilling Contractor for or in connection with the works shall be made by the Principal whether or not water is found and/ or irrespective of its quality or quantity.

4.2 Delays/ Stoppages

The Drilling Contractor shall not be responsible for any stoppage or delay either in the commencement and/ or completion of the works caused [wholly or partly] by strike, lockout, industrial disturbance, breakdown of plant and equipment [which however shall be remedied by the Drilling Contractor without undue delay] or any other cause beyond the Drilling Contractor's control and the Principal shall not be entitled to cancel or rescind this agreement or claim damages by reason of such stoppage or delay herein described.

4.3 Bore Specifications

The Drilling Contractor shall have the right to reduce the diameter of the bore if in the Drilling Contractor's sole discretion it is considered it would be impractical to continue drilling without further reducing the diameter of the bore AND FURTHER the Drilling Contractor shall not be required to drill into rock unless so specifically provided in this agreement.

4.4 Reports/ Documents

The copyright subsisting in all drawings, reports, specifications, calculations, computer disks and other documents provided by the Drilling Contractor is owned by the Drilling Contractor. The Principal shall have a license to use the documents referred to above in connection with the works but shall not except as permitted by legislation and/ or regulation use or make copies of the documents other than in connection with the works.

4.5 Licensed Driller

The initial Drilling License/ Permit holder nominated by the Drilling Contractor is holder of License/ Permit Number.....

Notwithstanding such nomination the Drilling Contractor shall be entitled to nominate an alternative holder of a License/ Permit at any time while the works are being carried out.

5. Termination of Agreement

5.1 Termination

This agreement shall be terminated by any one or more of the following events:

- 5.1.1. At any time by written agreement between the parties.
 - 5.1.2 In the event the Principal is a body corporate, upon the Principal entering into liquidation whether compulsory or voluntary or otherwise then for the purpose of amalgamation or reconstruction or compromise with its creditors or having a receiver appointed over all or any part of its assets or taking or suffering any similar action in consequence of debt.
 - 5.1.3 If the Principal be an individual, then if the Principal dies or becomes bankrupt or insolvent or enters into any agreement with his creditors or takes or suffers any similar action in consequence of debt.
 - 5.1.4. By either party giving to the other party at least one [1] months notice in writing of its intention to terminate this Agreement.
 - 5.1.5 If a party commits a breach or non observance of this agreement the other party may terminate this Agreement forthwith by giving notice in writing to the defaulting party.
- 5.2 Any such termination under Clause 5.1 shall be without prejudice to the rights and obligations accrued under this Agreement prior to termination.

6. Entire Agreement and Variations

This Agreement represents the entire Agreement and understanding between the parties in relation to matters dealt with herein and no modification or alteration to the terms of this Agreement shall be binding unless such modification or alteration shall be in writing and signed by and/ or on behalf of each of the parties hereto.

7. Severability

If any provision of this Agreement shall be held invalid or unenforceable or to violate any applicable law in force, this Agreement shall be construed as if such provisions were not contained herein.

8. Governing Law

This Agreement and any issue arising thereunder shall be governed by and construed according to the laws of the State or Territory where the works are carried out by the Drilling Contractor and where appropriate the Commonwealth of Australia.

9. Notice

Any notice to be given under this Agreement shall be in writing and shall be given by facsimile transmission, telex, telegram or registered letter addressed to the respective addresses of the parties described herein.

10. Arbitration

Any disputes or differences between the Principal and the Drilling Contractor arising out of or in connection with this Agreement may be submitted to Arbitration in accordance with the laws of the State or Territory where the works are carried out, PROVIDED HOWEVER this provision shall not in any way hinder or prevent the Drilling Contractor from instituting legal proceedings at any time in any court or tribunal of competent jurisdiction to recover any monies owed to the Drilling Contractor by the Principal.

Signed by the said]
in the presence of]

Signed by the said]
in the presence of]

Water Bore Agreement Prepared by The Australian Drilling Industry Association Limited

DISCLAIMER

While all due care has been taken in preparing this document, it can only be a guide to its users because the legislative scheme and/ or law varies between the States and Territories of Australia. The Australian Drilling Industry Association Limited [ACN 002 772 929] therefore accepts no liability or responsibility for any loss or damage arising from any matter contained in or pertaining to this document.

© Australian Drilling Industry Association Limited [ACN 002 772 929], 1994.

Reviewed November 2011.

WATER BORE AGREEMENT
SPECIAL CONDITIONS OF CONTRACT

Principal:

Drilling Contractor:

The following special conditions are agreed to by the Principal and the Drilling Contractor:

Signed

Principal

Date

Drilling Contractor

Date

© Australian Drilling Industry Association [ACN 002 772 929], 1994.

Reviewed November 2011.

CONDITIONS OF ENGAGEMENT

These conditions of engagement apply to all contracts for the provision of services by:

And should be read in conjunction with the Company's written proposal or acknowledgment of order. Unless otherwise expressly agreed in writing, these conditions shall apply to the exclusion of any contrary conditions that may appear on any order form or other document issued by the Principal with regard to this contract. They shall apply to any variations which may be agreed to or ordered within the scope of the work and to any supplementary work on the project which may be the subject of verbal or written agreement.

1. Definitions

In the following conditions of engagement:

[a] "The Company" means:

[b] "The Principal" means the person or organisation to whom the Company is contracted to provide services, and who is ultimately responsible for payment. The Principal may be represented by an agent, such as a consulting engineer, architect, hydrogeologist or the like, and who arranges for and directs the services on the Principals behalf.

2. Role of the Principal

The Principal is requested to provide us with the following, where relevant to the project:

2.1 Access

To provide good and safe access to the property and the drilling site.

2.2 Firebreaks

Prior to the commencement date ensure that all necessary firebreaks have been provided.

2.3 Permits etc.

To obtain and satisfy all municipal shire and governmental permits and requirements in relation to the works except for those agreed in the works documents/ contracts to be the responsibility of the Company

2.4 Survey Plans

To provide and have checked survey plans and data regarding underground services.

2.5 Site Hazards

To provide all information in writing, prepared by a properly qualified person, necessary for the Company to assess any hazards present on the site. In the event that the Company assesses the site as containing a hazard or a potential hazard, the costs and expenses of occupational health and safety precautions that the Company deems necessary arising out of the hazard or potential hazard, shall be an additional expense and shall be borne by the Principal.

2.6 Bore Location

Prior to the commencement of works to suitably mark the site for each bore with a stake or flag or other distinguishable means and to provide the Company with a map of the property identifying the position of the proposed bores and ensure that the drill site is accessible, and ensure that a correct survey of the bore locations has been carried out.

The Company shall not be responsible for any error of location in relation to the bores and the location of the drilling sites shall be totally the Principal's responsibility.

2.7 Indemnity

To indemnify the Company against claims from the Principal, the Principal's agents contractors or subcontractors servants or invitees such that the Company's total aggregate liability shall not exceed the amount of the insurance cover as provided in Clause 6 hereof.

3. Basis of Proposal

Unless specifically referred to as a lump sum, our proposal is based on a schedule of rates basis wherein our actual charges will be based on the quantities of work performed. Where an estimate of total cost is provided, it is based on information provided by the Principal or his Agents. The estimate could possibly be exceeded if undisclosed or unexpected conditions are encountered. We will endeavour to complete the work at a cost which is within the estimate given, and will advise and seek written authorisation from the Principal or his Agent if the estimate is to be significantly exceeded.

Should any activity be required or ordered which is outside the scope of the Principals original request, proposal, or tender document, the Company will charge for such additional work at the current standard hourly rates for personnel and equipment. No additional work will be carried out without a written order from the Principal or his Agent.

Hire of outside services, if necessary, will be charged at cost +7.5% for procurement.

4. Limitation of Offer

Our proposal is expressly conditional on the credit worthiness of the Principal being established to our satisfaction, and the acceptance of Clause 2.5 of these Conditions of Engagement in its entirety.

5. Terms of Payment

Invoices will be rendered either monthly, or if the work program is less than one month on completion of the project. Invoices are due for payment 21 days after submission to the Principal or his Agent.

6. Responsibility and Liability

The Company will undertake to exercise reasonable care, skill and diligence in accordance with standards ordinarily exercised by members of the profession.

** The liability of the Company to the Principal in respect of work carried out on the project shall be limited to the resupply of the services [if relevant], plus the amount of three times the contract price or \$20,000 [twenty thousand dollars], whichever is the lesser.

OR

** At all times keep current and maintain during the performance of the works professional indemnity insurance as hereinbefore provided in the sum of \$1.0 million, such insurance to cover claims resulting from the Company's action or injury to the Company's employees or accident with the Company's plant or equipment or any other claims usually covered by professional indemnity insurance carried by drillers and the liability of the Company shall be limited to the amount of such insurance.

[** Delete whichever item is not applicable]

The Principal agrees to indemnify the Company against claims from the Principal, his agents, contractors or sub-contractors such that the amount of the Company's total aggregate liability shall not exceed the amount indicated above.

No action shall lie against the Company at the suit of the Principal after the expiration of one year from the Company's involvement in the project.

7. Reports/ Documents

The copyright in all drawings reports specifications calculations computer disks and other documents provided by the Company shall remain the property of the Company. The Principal shall have a license to use the documents referred to above in connection with the works but shall not save as required by Government legislation or regulation use or make copies of such documents other than in connection with such works.

8. Settlement of Disputes

That any disputes between the Principal and the Company shall be submitted to Arbitration in accordance with the law relating to Arbitration in the State or Territory in which the works are carried out PROVIDED HOWEVER this provision shall not in any way hinder or prevent the Company from instituting legal proceedings at any time to recover any monies that are owed to the Company.

9. State or Territory

That the relationship between the Principal and the Company and any relationship arising pursuant to this document shall be governed by the laws of the State or Territory in which the works are carried out.

10. Supervision

The Company, as the drilling company, will at all times be available and carry out all supervisory work required to effectively complete the works agreed to be undertaken in accordance with all Government, Statutory, and contractual requirements.

(sample)

DEED OF INDEMNITY AND GUARANTEE

To Uphole Drilling Pty. Ltd [ACN 003 662 819]
Registered Office: 12 Success St, Perth WA 6000

IN CONSIDERATION of you entering into the within Agreement with

James Smith Pastoral Company Pty. Ltd[ACN 006 456 987]
Registered Office: 34 The Esplanade, Fremantle WA 6160

Hereinafter called "the Principal" at our request we*

Frederick James Smith, Company Director
of 31 Beech St, Fremantle WA 6160

Elsie Joan Smith, Company Director
of 31 Beech St, Fremantle WA 6160

[* hereinafter called "the indemnifiers"]

1. Undertake to indemnify you and keep you indemnified against any failure of the Principal to perform and observe the terms and conditions of the said Agreement whether or not the same are enforceable by you against the Principal.
2. Guarantee to you that the Principal will punctually perform and observe all of the Principal's obligations under the said agreement including the due and punctual payment of all monies payable by the Principal under the said agreement.
3. Agree that if at any time any of the obligations of the Principal or any of the terms and conditions of the said Agreement are not duly and punctually observed and performed, the Indemnifiers will observe and perform the same and pay all your costs [as between Solicitor and own client] and expenses arising out of or in connection with the non-observance or non-performance of the Principal of the said Agreement or of this Deed of Indemnity and Guarantee.
4. In so far as the obligations of the Indemnifiers are those of the Guarantors agree that this Guarantee shall be a continuing Guarantee and that:
 - [a] Any time or other indulgence allowed by you to the Principal or to any other Guarantor under this or any other Guarantee;
 - [b] The invalidity or unenforceability either in whole or part of the said Agreement;
 - [c] The variation of any of the terms of the said Agreement;
 - [d] The discharge of the Principal whether by operation of rule or in any manner otherwise than by a full and complete performance by the Principal of all the obligations to be performed and observed by the Principal or your inability for any reason to sue the Principal upon the said agreement or to recover any amounts due thereunder from the Principal

shall not exonerate nor discharge the Indemnifiers or in any way prejudice or affect the liability of the Indemnifiers hereunder.

5. Agree that if the payment of any money or the performance of any other obligation by the Principal under the said Agreement is avoided set aside or otherwise rendered ineffective by statute or otherwise by operation of the law that payment or performance as the case may be shall be deemed not to have discharged the obligations of the Indemnifiers hereunder and the obligations of the Indemnifiers hereunder shall be the same as if the said payment had not been made or obligation performed and that the Indemnifiers will forthwith upon the payment of any money or the performance of any other obligation being so avoided set aside or rendered ineffective owe the said money or perform the same obligations as the case may be.

6. Agree that this Deed of Indemnity and Guarantee is in addition to and not in substitution for any other security and that it may be enforced without recourse having first been made to such security and without any steps or proceedings having been taken against the Principal.
7. Agree that all monies received by you from or on account of the Principal including any dividends paid in the bankruptcy or winding up of the Principal or in the course of any other administration of the affairs of the Principal in the belief that the Principal is unable to pay the debts of the Principal as they fall due any sums resulting from the realisation or enforcement of any other security capable of being applied by you in reduction of the indebtedness of the Principal shall be regarded for all purposes as payments in gross without any rights on the Indemnifiers part to stand in your place or claim the benefit of any monies so received until the total indebtedness of the Principal to you has been paid.
8. Agree that the Indemnifiers shall in respect of all sums paid by the Indemnifiers hereunder and in respect of any other rights which may accrue howsoever to the Indemnifiers in respect of any sum so paid rank and be entitled to enforce the same only after all the monies hereby secured shall have been duly paid and satisfied and in the event of the bankruptcy or winding up of the Principal or in the course of any other administration of the affairs of the Principal on the belief that the Principal is unable to pay the debts of the Principal as they fall due the Indemnifiers will not prove in the same in competition with you and that the Indemnifiers hereby waives in your favour all rights whatsoever against the Principal so far as may be necessary to give effect to anything in this Deed of Indemnity and Guarantee contained.
9. Agree that this Deed of Indemnity and Guarantee will ensure for the benefit of you, your successors and assigns and shall be binding on the Indemnifiers and the Indemnifiers personal representatives, successors and assigns.
10. Where two or more persons enter into this Deed agree that the obligations of the Indemnifiers hereunder shall bind them and any two or more of them jointly and each of them severally and that the expression "the Indemnifiers" as herein used shall mean and include those persons and each or any one of them.
11. Agree that this Deed of Indemnity and Guarantee shall be governed and construed in accordance with the laws of the State of Western Australia and that if any action thereon be taken in the Supreme Court of Western Australia, that the service of any Writ or Summons in any other action or the giving of any notice under or pursuant to this Deed of Indemnity and Guarantee may be effected by posting a copy of such Writ or such notice by prepaid post addressed to the Indemnifiers at the Indemnifiers address shown herein and that such copy Writ or notice shall be deemed conclusively to have been received by the Indemnifiers on the day after the date on which it is posted.

DATED the _____ day of _____ 20____

SIGNED SEALED AND DELIVERED by the _____)
said Frederick James Smith _____)
in Western Australia in the presence of _____)

SIGNED SEALED AND DELIVERED by the _____)
said Elsie Joan Smith _____)
in Western Australia in the presence of _____)

(sample)

DOCUMENTS SIGNED UNDER SEAL

THE COMMON SEAL OF.....)
PTY. LTD {ACN })
was hereunto affixed in accordance with its)
Articles of Association in the presence of:)

Director.....

Secretary.....

SIGNED by the said.....)
in the presence of:)

Witness.....

SIGNED by the said.....)
in the presence of:)

Witness.....)

edition

3

