



Department of **Planning,
Lands and Heritage**



DRAFT
PUBLIC CONSULTATION
NOT INTENDED FOR DECISION MAKING

draft
**Planning for Bushfire
Guidelines**

For the implementation of State Planning Policy 3.7
Bushfire

April 2023

The Department of Planning, Lands and Heritage acknowledges the traditional owners and custodians of this land. We pay our respect to Elders past and present, their descendants who are with us today, and those who will follow in their footsteps.

Disclaimer

This document has been produced by the Department of Planning, Lands and Heritage on behalf of the Western Australian Planning Commission. Any representation, statement, opinion or advice expressed or implied in this publication is made in good faith and on the basis that the Government, its employees and agents are not liable for any damage or loss whatsoever which may occur as a result of action taken or not taken, as the case may be, in respect of any representation, statement, opinion or advice referred to herein. Professional advice should be obtained before applying the information contained in this document to particular circumstances.

© State of Western Australia

Published by the
Western Australian Planning Commission
Gordon Stephenson House
140 William Street
Perth WA 6000

Locked Bag 2506
Perth WA 6001

Publication date: 19/04/2023

website: wa.gov.au/dplh
email: info@dplh.wa.gov.au

tel: 08 6551 8002
fax: 08 6551 9001
National Relay Service: 13 36 77

This document is available in alternative formats on application to the Department of Planning, Lands and Heritage Communications Branch.

CONTENTS

[click to follow](#)

1	INTRODUCTION	1	5	STRATEGIC PLANNING PROPOSALS	13
1.1	Purpose of these guidelines	1	5.1	Design considerations	13
1.2	How the guidelines apply	1	5.2	Information to accompany a strategic planning proposal	14
2	SUPPORTING REGULATORY FRAMEWORK	2	6	STRUCTURE PLANS (WHERE THE LOT LAYOUT AND/OR INTERNAL ROAD NETWORK IS KNOWN) AND SUBDIVISION APPLICATIONS	17
2.1	Map of Bush Fire Prone Areas	2	6.1	Infill (residential) subdivision within Area 1 on the Map of Bush Fire Prone Areas	17
2.2	Planning requirements in Bush Fire Prone Areas	3	6.2	Design considerations	17
2.3	Local or regional variations to the guidelines	4	6.3	Information to accompany a structure plan or subdivision application	19
2.4	Local planning policies that address bushfire	4	6.4	Bushfire subdivision conditions	20
2.5	Supporting fact sheets and technical notes	4	6.5	Compliance certificate for subdivision	20
2.6	Building permit process	5	6.6	Staged subdivision	21
2.7	Biodiversity and environment	5	7	DEVELOPMENT - RESIDENTIAL	27
3	HOW TO USE THE GUIDELINES	6	7.1	Design considerations	27
3.1	Guiding principles	6	7.2	Development sites within BAL-40 or BAL-FZ	27
3.2	How to demonstrate compliance with SPP 3.7	6	7.3	Information to accompany the development application or subdivision	28
4	HIGHER-ORDER STRATEGIC PLANNING DOCUMENTS	11	7.4	Building permit process and bushfire construction requirements	28
4.1	Design considerations	11	7.5	Class 10A buildings or decks	29
4.2	Information to accompany a higher-order strategic planning document	11			
4.3	Synergies with existing local government bushfire documentation	12			

Development within designated bushfire prone areas that is consistent with planning policy and building controls, including the bushfire protection criteria within the Guidelines, does not guarantee no loss of life, injury and/or property damage during a bushfire event. The bushfire protection criteria are based on the best available knowledge of bushfire and mitigation measures and aim to significantly reduce the threat of bushfire; however, the risk of bushfire impacting on life or property cannot be eliminated.

DRAFT

PUBLIC CONSULTATION
NOT INTENDED FOR DECISION MAKING

CONTENTS

8	DEVELOPMENT – COMMERCIAL, INDUSTRIAL AND COMMUNITY USES	33	10.7	Department of Climate Change, Energy, the Environment and Water (Australian Government)	52	Figures	
8.1	Design considerations	33	10.8	Department of Water and Environmental Regulation	52	Figure 1: Extract of Map of Bush Fire Prone Areas	2
8.2	Information to accompany the development application	35	10.9	Department of Biodiversity, Conservation and Attractions	52	Figure 2: The Western Australian Bushfire Prone Areas statutory and policy framework flowchart	3
9	VULNERABLE TOURISM LAND USES	40	10.10	State Administrative Tribunal	52	Figure 3: Assessing bushfire risk in the planning context	7
9.1	Design considerations	40	ACRONYMS		53	Figure 4: BAL construction levels in context	10
9.2	Contingency measures to mitigate risk	42	DEFINITIONS		54	Figure 5: Subdivision and development design	18
9.3	Information to accompany the development application	43	APPENDIX A – BUSHFIRE PROTECTION CRITERIA EXPLANATORY NOTES		57	Figure 6: Topography considerations for building locations	19
9.4	Bushfire emergency plan	43	APPENDIX B – BUSHFIRE ASSESSMENT METHODOLOGIES		81	Figure 7: Structure plan where the SPP applies to the proposed lots designated as bushfire fire prone on the Map	20
9.5	Conditions of development approval where on-site shelter is proposed	43	APPENDIX C – A GUIDE TO DEVELOPING A BUSHFIRE MANAGEMENT PLAN		106	Figure 8: Example of creating a balance lot in BAL-40/FZ until the adjacent bushfire hazard is removed	21
10	ROLES AND RESPONSIBILITIES	49	APPENDIX D – A GUIDE TO DEVELOPING A BUSHFIRE EMERGENCY PLAN		108	Figure 9: Design of an APZ	66
10.1	Landowners/proponents	49				Figure 10: Area encompassing horizontal clearance and vertical clearance	69
10.2	Local governments	49				Figure 11: Example of compliant and non-compliant two-way access	70
10.3	Western Australian Planning Commission/ Department of Planning, Lands and Heritage	50				Figure 12: Demonstration of a lot achieving two-way access within 200 metres	71
10.4	Department of Fire and Emergency Services	51				Figure 13: Example of a site on a no-through road greater than 200 metres but within 200 metres of BAL-LOW	71
10.5	Office of Bushfire Risk Management	51				Figure 14: Design requirements for a turn-around area for a no-through road	71
10.6	Department of Mines, Industry Regulation and Safety (Building and Energy Division)	51					

DRAFT

PUBLIC CONSULTATION
NOT INTENDED FOR DECISION MAKING

CONTENTS

Figure 15: Example of a 9 metre wide emergency access way	72	Figure 32: Broader landscape type B aerials	90	Table 9: Vegetation classification map colour codes for classifying vegetation	98
Figure 16: Example of a 12 metre wide emergency access way	72	Figure 33: Broader landscape type C aerial	91	Table 10: BAL Contour Map – colour codes for contours	102
Figure 17: Example of where an emergency access way may be provided	73	Figure 34: Sample vegetation classification map (BHL assessment)	95		
Figure 18: Example of a 6 metre wide emergency access way	73	Figure 35: Sample BHL assessment map	96		
Figure 19: Example of a perimeter road	74	Figure 36: Sample vegetation classification map (BAL Contour Map)	99		
Figure 20: Example of a fire service access route	76	Figure 37: Sample BAL Contour Map	101		
Figure 21: Battle-axe design requirements	76	Figure 38: Measurement of distance between a house and the bushfire prone vegetation	105		
Figure 22: Design requirements for a private driveway where required	77				
Figure 23: A good and bad example of landscaping around a water tank	80	Tables			
Figure 24: Assessment process for Element 1	82	Table 1: BAL and corresponding descriptions of the predicted levels of exposure and heat flux exposure thresholds	9		
Figure 25: How to determine the Broader Landscape Assessment area	83	Table 2: Examples of additional mitigation measures	60		
Figure 26: Broader Landscape Assessment area for multiple development sites	83	Table 3: Asset Protection Zone (APZ) technical requirements	63		
Figure 27: Example of Vegetation type and whether it is continuous or fragmented	84	Table 4: Vehicular access technical requirements	68		
Figure 28: Example of aspect assessment	85	Table 5: Water supply dedicated for bushfire firefighting purposes	78		
Figure 29: Example of effective slope	86	Table 6: Points-based system for determining a broader landscape type	88		
Figure 30: Example of access routes	87	Table 7: BHL and vegetation classification (as per AS 3959)	93		
Figure 31: Broader landscape type A aerials	89	Table 8: BHL assessment map colour codes for classifying vegetation	94		



1 INTRODUCTION

The *Planning for Bushfire Guidelines* should be read in conjunction with *State Planning Policy 3.7: Bushfire* (SPP 3.7). These Guidelines replace the *Guidelines for Planning in Bushfire Prone Areas* Version 1.4 (December 2021).

1.1 PURPOSE OF THESE GUIDELINES

The Guidelines are designed to assist in the demonstration and interpretation of the SPP 3.7 objectives, outcomes and measures. Specifically, they assist with:

- specifying the requirements to address SPP 3.7 at each stage of the planning process
- determining appropriate land-use and development form, construction standards and siting within designated bushfire prone areas
- providing an assessment framework to demonstrate compliance with the bushfire protection criteria.

1.2 HOW THE GUIDELINES APPLY

SPP 3.7 and the Guidelines apply where the land is designated bushfire prone on the *Map of Bushfire Prone Areas* and the planning proposal will:

- result in the intensification of development (or land use); and/or
- result in an increase of visitors, residents or employees; and/or
- adversely impact or increase the bushfire risk to the subject or surrounding site(s).

‘Bushfire risk’ is defined as “the chance of a bushfire igniting, spreading and causing damage to people, property and infrastructure”.

In some instances, the decision-maker may determine that partial application of SPP 3.7 and the Guidelines is necessary. This may include applications that do not include a habitable building and do not result in an increase in bushfire risk. For example, an extractive industry where the extraction is undertaken in an open cleared area and no habitable buildings are proposed. There are no requirements to demonstrate compliance with Element 2: siting and design, however due to the number of persons on-site and/or potential evacuation challenges, partial application of SPP 3.7 and the bushfire protection measures, may be necessary. This could include demonstration of Element 3: vehicular access and Element 4: water supply, and/or the preparation of a bushfire emergency plan.

Examples of when SPP 3.7 and the Guidelines may not apply, include but are not limited to:

- a subdivision application where there is no increase in the development potential and therefore no intensification of land use or bushfire risk, such as a boundary realignment, that does not restrict the ability to establish or maintain an Asset Protection Zone; and does not restrict vehicular access/egress to any existing or future habitable building
- a development application for incidental non-habitable buildings located not less than 6 metres from the habitable building, including but not limited to, outbuildings, unenclosed swimming pools, carports, patios, fences and storage sheds
- a development application for minor renovations, extensions, alterations, improvements or repair of an existing habitable building

- where the application does not result in an increase of occupants onsite; and/or
- where there is no increase in the bushfire risk, such as the extension being closer to the bushfire hazard, or the extension restricts or limits compliance with vehicular access or affects the provision of water to the development.
- a development application for an existing land use previously considered by SPP 3.7, where the land use has not changed, but requires renewal on a reoccurring basis
- a development application proposing a change of use within an existing residential habitable building where the use is consistent with the residential nature of the dwelling, particularly the number of persons accommodated on-site at any one time, and where the owner/resident is on-site (hosted). This includes a home office, home occupation, family day-care, and bed and breakfasts.

1.2.1 Areas that pose a future hazard but are not yet designated

Where the subject site is not designated as a bushfire prone area on the *Map of Bush Fire Prone Areas*, but the strategic planning proposal, subdivision or development application incorporates the revegetation of wetlands or foreshores or similar which may introduce a bushfire hazard, the decision-maker should inform the Office of Bushfire Risk Management to consider this area in the next revised version of the *Map of Bush Fire Prone Areas*.

Any such strategic planning proposal, subdivision or development application should apply the provisions of SPP 3.7 and the Guidelines.



2 SUPPORTING REGULATORY FRAMEWORK

2.1 MAP OF BUSH FIRE PRONE AREAS

SPP 3.7 and the Guidelines apply to land that has been designated as being bushfire prone by the Fire and Emergency Services Commissioner under section 18P of the *Fire and Emergency Services Act 1998*. This designation is made in the form of an order published in the Government Gazette that refers to the *Map of Bush Fire Prone Areas*, which can be sourced on the [Department of Fire and Emergency Services' website](#). Designation of an area as bushfire prone reflects the potential of bushfire to affect that site.

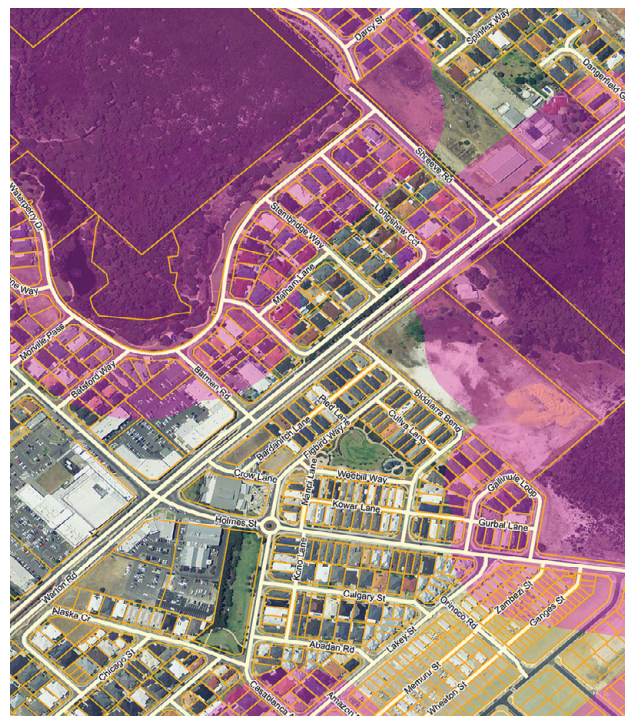
The *Map of Bush Fire Prone Areas* has been developed by the Office of Bushfire Risk Management, which forms part of the Rural Fire Division of Department of Fire and Emergency Services. OBRM is responsible for preparing, maintaining and administering the *Map of Bush Fire Prone Areas* and *Mapping Standard for Bush Fire Prone Areas* on behalf of the Fire and Emergency Services Commissioner.

The Map includes two designations, being Area 1 and Area 2. Area 1 covers the built-up urbanised areas of Perth, Peel and Bunbury, which present a lesser risk of loss of life, property or infrastructure in the event of a bushfire. Area 2 covers the rest of the State of Western Australia.

A transitional period will apply to newly designated areas following every update of the *Map of Bush Fire Prone Areas*. Once the transitional provisions have expired, existing local government bushfire maps will no longer provide for the designation of areas as being bushfire prone, unless

the area is identified in a special control area. Any inconsistencies between the *Map of Bush Fire Prone Areas* and local government bushfire mapping must be identified to the Office of Bushfire Risk Management by local governments for consideration in their annual map review as per the review procedures outlined in the *Mapping Standard for Bush Fire Prone Areas*.

Figure 1: Extract from *Map of Bush Fire Prone Areas*



Bushfire prone vegetation is determined according to the criteria outlined in the *Mapping Standard for Bush Fire Prone Areas* and is identified on the *Map of Bush Fire Prone Areas* prepared by the Office of Bushfire Risk Management. Further information on how the map is prepared and updated can be found in the *Mapping Standard for Bush Fire Prone Areas*.

The *Map of Bush Fire Prone Areas* is available on the Department of Fire and Emergency Services' website www.dfes.wa.gov.au/bushfireproneareas using the Shared Location Information Platform (SLIP) managed by Landgate. While the map should not be made to form part of a local planning scheme, local governments will be able to include the mapping of their current bushfire prone areas within their geospatial information systems (GIS) to inform their planning decisions. When a state map is released, local governments will be able to access the new layer from SLIP.



2.2 PLANNING REQUIREMENTS IN BUSHFIRE PRONE AREAS

The *Map of Bush Fire Prone Areas* provides a single means of identifying whether a site is designated under law as being bushfire prone at the state level. The *Map of Bush Fire Prone Areas acts* as a trigger to determine whether bushfire protection planning and building requirements apply. Individual local planning schemes may also contain special control areas that designate areas as bushfire prone which may have more detailed hazard mapping and additional planning requirements.

The SPP 3.7 and Guidelines are to be used to guide the preparation and assessment of a bushfire management plan to support the following:

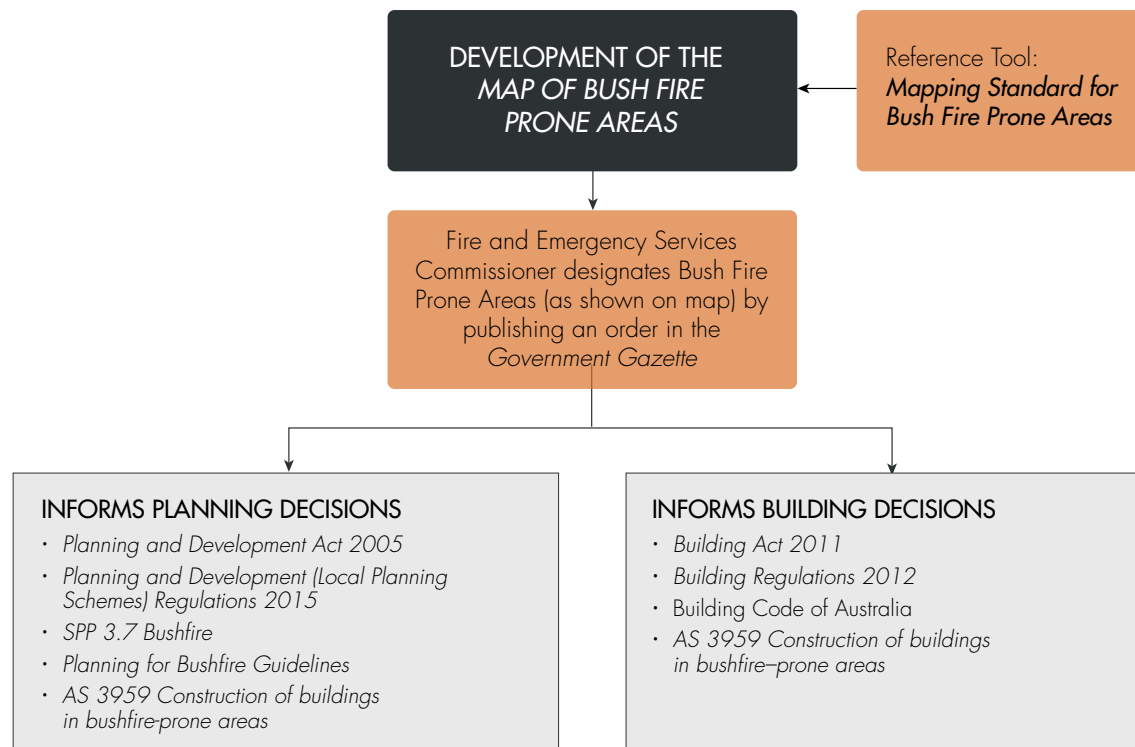
- higher-order strategic planning documents (including regional and sub-regional frameworks, region schemes, sub-regional strategies, district structure plans and local planning strategies)
- strategic planning proposals (including local planning schemes and amendments and structure plans where the lot layout and/or internal road layout is not known)
- structure plans (where the lot layout and/or internal road network is known) and subdivision applications
- applications for development approval (hereafter referred to as development applications) for vulnerable land uses
- development applications for the use and/or construction of habitable buildings.

Habitable building means a permanent or temporary structure on land that:

- is fully or partially enclosed
- has at least one wall of solid material and a roof of solid material
- is used for a purpose that involves the use of the interior of the structure by people for living, working, studying or being entertained.

Specified building means a structure of a kind specified in LPS Regulations 2015 as a kind of structure to which Part 10A applies in addition to its application to habitable buildings.

Figure 2: The Western Australian Bushfire Prone Areas statutory and policy framework flowchart





2.2.1 Local Planning Scheme (LPS) Regulations 2015 – deemed provisions for local planning schemes

The LPS Regulations 2015 include deemed provisions relating to bushfire risk management that apply to all local planning schemes made under Part 5 of the *Planning and Development Act 2005*. These deemed provisions are included under Schedule 2 Part 10A of LPS Regulations 2015.

Where a local planning scheme applies, habitable or specified buildings, are to be assessed against SPP 3.7. Schedule 2 Part 10A of the LPS Regulations trigger the need for development approval where the BAL indicates BAL-40 or BAL-Flame Zone (FZ), even in circumstances where the need for development approval would otherwise be exempt under Schedule 2 Part 7 of LPS Regulations 2015. Exemptions under Schedule 2 Part 7 of LPS Regulations 2015 include development that is compliant with *State Planning Policy 7.3 Residential Design Codes*.

The Schedule 2 Part 10A of the LPS Regulations applies to:

- the construction or use, or construction and use of a single house or ancillary dwelling on a lot(s) with a total area of 1,100 m² or more; or
- the construction or use, or construction and use of a habitable building other than a single house or ancillary dwelling or a specified building.

The provisions contained in Schedule 2 Part 10A of the LPS Regulations prevail over any existing local planning scheme provisions relating to bushfire, including any inconsistent provisions. In accordance with Schedule 2 clause 78B (2) of LPS Regulations 2015, these requirements are in addition to any provisions relating to development

in a bushfire prone area that apply through the local planning scheme provisions for a special control area. Schedule 2 Part 10A of the LPS Regulations does not apply to land where there is no existing local planning scheme or where a local planning scheme has ceased to have legal effect.

The Schedule 2 Part 10A of the LPS Regulations can be supplemented but not varied or exempted. Any new supplemental provisions require a special control area to be implemented under the scheme amendment process set out in the *Planning and Development Act 2005*.

2.3 LOCAL OR REGIONAL VARIATIONS TO THE GUIDELINES

Local governments may seek to add to or modify the acceptable solutions contained within the Guidelines, to recognise special local or regional circumstances (for example, topography, vegetation or climate) that reinforce the SPP 3.7 objectives and outcomes.

Regional or local variations should form part of a local planning strategy and/or local planning scheme via a scheme amendment or special control area, as opposed to being included in a local planning policy. They will be assessed on a case-by-case basis and should be supported by justification that clearly:

- explains the reasons why the modification or addition is required; and
- demonstrates to the satisfaction of the Western Australian Planning Commission (WAPC) that the modifications comply with the corresponding SPP 3.7 outcomes and objectives.

2.4 LOCAL PLANNING POLICIES THAT ADDRESS BUSHFIRE

Local planning policies are prepared by local governments to help inform and guide the preparation, assessment and discretionary decision-making of planning applications at the local government level. Local planning policies may be useful to provide additional guidance to bushfire provisions that are not appropriate for inclusion in mandatory scheme provisions.

Local governments are encouraged to refer their draft local planning policies that address bushfire issues to the WAPC and the Department of Fire and Emergency Services (DFES) for comment prior to being adopted and implemented. It should be noted that in accordance with Schedule 2 Part 2, Clause 4(1)(b) of the deemed provisions, where a proposed local planning policy is inconsistent with a State Planning Policy, it must be referred to the WAPC for comment.

For subdivision applications, while the local planning policy may guide the local government's advice to the WAPC, the WAPC is under no obligation to have regard for a local planning policy.

2.5 SUPPORTING FACT SHEETS AND TECHNICAL NOTES

The WAPC may prepare fact sheets where supplementary information and advice is required on how to apply the Guidelines. These fact sheets will be prepared and managed by the Department of Planning, Lands and Heritage and form part of the Guidelines where approved by the WAPC. They can be found on the Department of Planning, Lands and Heritage's website.



The Department of Fire and Emergency Services and the Department of Mines, Industry Regulation and Safety (Building and Energy Division) may prepare technical notes and industry bulletins on elements of bushfire risk management and construction standards that are complementary to the information contained in these Guidelines. Any technical notes will be owned and managed by the respective agencies and will not form part of the Guidelines or assessment requirements to comply with SPP 3.7.

Where there is a discrepancy between the Guidelines and other agency technical notes or bulletins, the Guidelines will prevail. Where there is a discrepancy between the Guidelines and Australian Standard 3959 Construction of buildings in bushfire prone areas (AS 3959), AS 3959 prevails.

2.6 BUILDING PERMIT PROCESS

Under the *Building Act 2011* and the *Building Regulations 2012*, building work in Western Australia requires a building permit before construction can commence (unless an exemption applies). This process typically occurs after the development approval (if required) and is a separate process to the development approval process.

The building legislation adopts the Building Code of Australia (BCA) as the primary applicable building standard for all new buildings and incidental structures in Western Australia. The BCA also applies to new building work to existing buildings. The BCA sets out the minimum technical requirements for the design and construction of buildings and includes specific bushfire construction requirements for certain types of buildings located in designated bushfire prone areas.

The BCA bushfire construction requirements apply to a Class 1, 2 or 3 building, or a Class 10a building or deck associated with a Class 1, 2 or 3 building, located in a designated bushfire prone area. Concessions from the requirement to comply with the BCA bushfire construction requirements may apply to some types of renovations, alterations, extensions, improvements or repairs of an existing building.

The 2019 edition of the BCA does not require Class 4, 5, 6, 7, 8 or 9 buildings to comply with bushfire construction requirements. However, it is expected that certain types of Class 9 buildings (such as health care buildings, early childhood centres, primary or secondary schools and residential care buildings) will need to address bushfire construction requirements when the 2022 edition of the BCA takes effect in Western Australia.

Specific queries regarding the bushfire construction requirements that apply to a particular building should be directed to the registered building surveyor who will be certifying the compliance of that building against the applicable building standards. General information on the building permit process, including whether a building permit is required for a specific building, may be obtained from the building department at the local government authority.

2.7 BIODIVERSITY AND ENVIRONMENT

Bushfire prone areas are often rich in biodiversity, hold ecological value to flora and fauna communities and provide natural amenity to surrounding development. SPP 3.7 recognises the need to achieve an appropriate balance between the modification and removal of native vegetation for bushfire risk management, biodiversity conservation and landscape amenity.

Areas may include wetlands, foreshores, Bush Forever sites, remnant native vegetation, threatened species and ecological communities, nature reserves and coastal reserves. Bushfire management plans should consider the applicable State Planning Policies and publications, in addition to:

- any local government biodiversity strategies or similar
- whether the site, or a portion of the site, has been identified as a vegetation corridor, an environmentally sensitive site or identified in a planning document as being, or proposed to be, reserved for a conservation, recreation or environmental protection purpose (such as an ecological linkage, local natural area, foreshore area or wetland buffer)
- any visual amenity issues, including any landscape plans that have been prepared over the site
- the broader landscape, including the location of any sites within or adjacent to the site that may be revegetated
- requirements of relevant environmental legislation, such as *Part V of the Environmental Protection Act 1986*, *Environmental Protection (Clearing of Native Vegetation) Regulations 2004*, the *Biodiversity Conservation Act 2016*, the *Environment Protection and Biodiversity Conservation Act 1999* and the *Western Australian Native Vegetation Policy 2022*.

Specific requirements for the consideration of biodiversity and environmental values at each planning stage are outlined in Sections 4 to 9 of the Guidelines. The Fact Sheet: [Bushfire and Vegetation](#) provides further detail on the legislative requirements for the modification and clearing of native vegetation.



3 HOW TO USE THE GUIDELINES

3.1 GUIDING PRINCIPLES

The following principles provide the contextual framework for the implementation of SPP 3.7. They should be used to guide the proponent and for the decision-maker to acknowledge when considering bushfire matters and making decisions in relation to planning and development.

Outcome-based decision-making

Planning and development decision-making should focus on achieving the policy outcomes of SPP 3.7.

Early consideration

Bushfire threat is identified and addressed as early as possible in the planning process and at all subsequent stages. Bushfire considerations should not be deferred if they are likely to pose issues that will become more difficult to resolve at subsequent planning stages.

Site-responsive solutions

The bushfire protection measures identified as acceptable solutions are a minimum only and cannot address every situation. Measures should be tailored to site-specific attributes and to address the potential impacts of activities undertaken on the site.

Risk management

The nature and scale of the required information, investigation or response provided should be commensurate with the significance of the bushfire threat and the level of risk the strategic planning proposal, subdivision or development could create.

Evidence-based decision-making

Planning decisions are supported by reliable, current and accurate evidence to objectively assess bushfire matters. Where preliminary investigations suggest an enhanced level of risk to the community is evident, more detailed investigations may be required.

Collaboration

The preparation and assessment of bushfire management plans should draw on all relevant disciplines through an integrated and collaborative approach to ensure all stakeholder interests and objectives are understood and considered. Early engagement with State and local government, assessing authorities, regulators, service providers, industry bodies and the community (where appropriate) is encouraged.

Precautionary principle

Where a strategic planning proposal, subdivision or development application does not satisfy the bushfire protection criteria, through compliance with the acceptable solutions and/or an outcomes-based approach, is not supported by science, evidence or knowledge and an understanding of the consequences have not been made available by the proponent to the decision-maker, the proposal should not be supported based on the application of the precautionary principle.

Intergenerational equity and climate change

The Commonwealth Scientific and Industrial Research Organisation (CSIRO), Australia's national science research agency, confirms that climate change is adding to Australia's natural climate variability, driving changes in average and extreme weather, now and into the future.

The summer bushfires of 2019-2020 provided only a glimpse of the types of events that Australia may face in the future. These catastrophic bushfire conditions highlight the increasing importance of planning for bushfire-resilient communities and that reliance on traditional bushfire protection measures are less effective.

3.2 HOW TO DEMONSTRATE COMPLIANCE WITH SPP 3.7

SPP 3.7 establishes the overarching policy objectives, policy outcomes and policy measures that should be satisfied for higher-order strategic planning proposals, strategic planning proposals, subdivision and development applications within bushfire prone areas.

The Guidelines provide information to assist in achieving the policy objectives, policy outcomes and policy measures at each of the different planning stages. Sections 4 to 9 are specific to a planning stage and provide information on:

- The type of strategic planning proposal, subdivision or development application
- Design considerations specific to the planning stage
- Environmental considerations specific to the planning stage



- Information to be provided to support the strategic planning proposal, subdivision or development application
- Bushfire assessment tools – broader landscape, BHL, BAL Contour and BAL assessment.
- Table of bushfire protection criteria for Element 1: location, Element 2: siting and design, Element 3: vehicular access and Element 4: water supply, specific to the application type
- Bushfire management plan and bushfire emergency plan (when required).

Additional explanatory text for each of the four Elements is provided in Appendix A.

Appendix B provides the methodology on how to prepare and review the bushfire assessments, using the relevant bushfire assessment tools required at different stages of the planning process.

Appendices C and D provide a guide to developing a bushfire management plan and bushfire emergency plan.

3.2.1 Assessing bushfire risk in the planning context

Bushfire assessment tools

In SPP 3.7, 'bushfire risk' is defined as "the chance of a bushfire igniting, spreading and causing damage to people, property and infrastructure" and in this context, 'bushfire risk management' is "the application of the bushfire protection criteria contained in these Guidelines". Before a strategic planning proposal, subdivision or development application can be considered, it is necessary to understand the extent of the bushfire hazard and its potential to affect people, property and infrastructure.

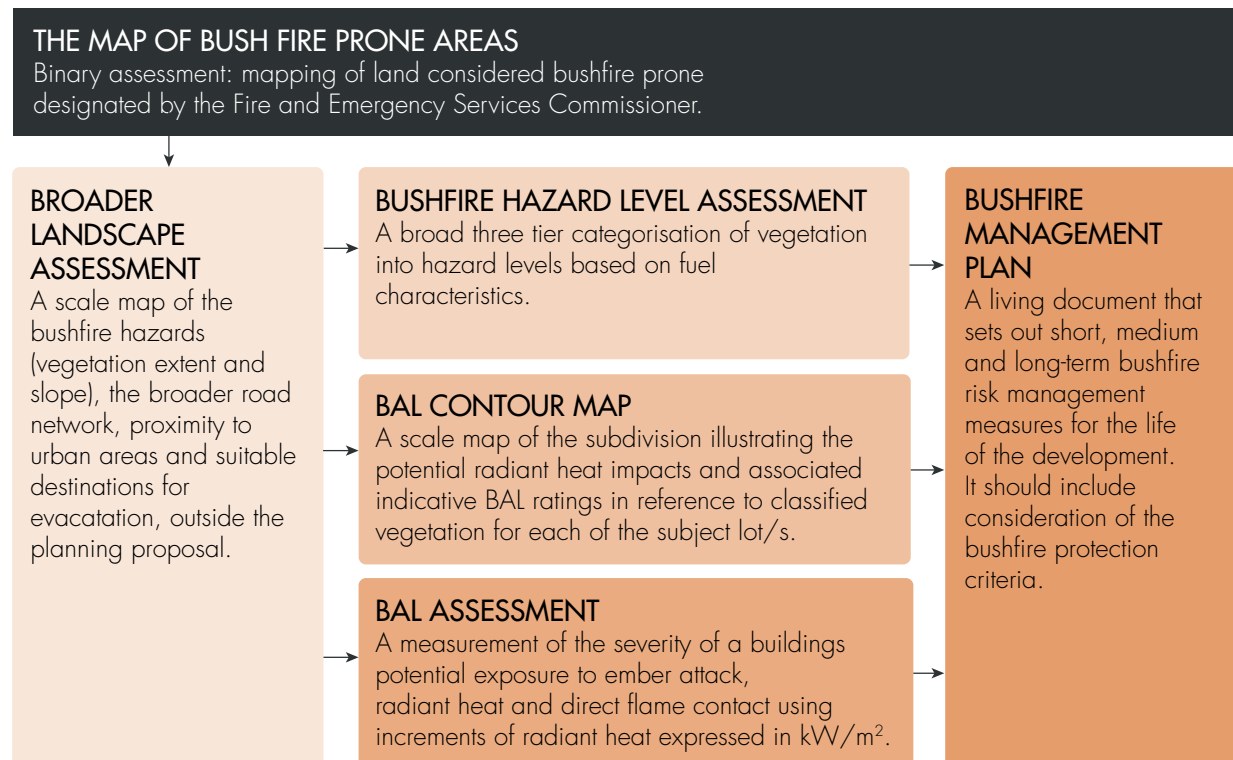
An assessment of bushfire risk is a key component of deciding whether a strategic planning proposal, subdivision or development application should be approved in an area with potential bushfire threat. Planning for, and assessing bushfire risk, is most effective when properly addressed at the earliest stage in the planning process.

As prescribed by SPP 3.7, this section sets out the interrelationships between, and requirements for, various assessment tools used to assess bushfire risk in the planning context (Figure 3).

Broader landscape assessment

The broader landscape is the area external to the strategic planning proposal, subdivision or development application, extending for a distance of up to 2 kilometres beyond the 150 metre BHL or BAL Contour assessment area. An assessment of the broader landscape includes the bushfire hazards (associated with vegetation type, extent and slope), the broader road network, proximity to urban areas and suitable destinations for evacuation, and

Figure 3: Assessing bushfire risk in the planning context





provides a means of determining the potential intensity, severity of a bushfire and the suitability of the location for intensification of development.

Strategic planning proposals, subdivision and development applications within an area designated as Area 1 on the *Map of Bushfire Prone Areas* will not require an assessment of the broader landscape or need to demonstrate compliance with Element 1: location, as these areas are built-up and the risk of a landscape scale bushfire resulting in loss of life, property and infrastructure is lower.

Where the following strategic planning proposals, subdivision and development applications are located within an area designated as Area 2 on the *Map of Bushfire Prone Areas*, they require an assessment of the broader landscape to demonstrate compliance with Element 1: location:

- a. All strategic planning proposals (Section 5)
- b. All structure plans and subdivisions (Section 6)
- c. Vulnerable (commercial/industrial/community) development (Section 8)
- d. Vulnerable tourism land uses where an outcomes-based approach is triggered (Section 9)

Refer to Appendix A.1 and B.1 for further information.

Bushfire hazard level (BHL) assessment

A BHL assessment provides a 'broad-brush' means of determining the potential intensity of a bushfire for a particular area. The BHL assessment assists in informing the suitability of land contained within strategic planning proposals for future subdivision and development.

The BHL assessment is an assessment tool used when the lot layout and/or detail of a development is not yet known. The assessment categorises land within a designated bushfire prone area as having a low, moderate or extreme BHL, and dependant on the level of detail available, will be based on the current or pre-development state of the vegetation, or the post development state of the vegetation. Refer to Appendix B.2 for further information.

Bushfire attack level (BAL) contour assessment

A BAL Contour Map is an assessment tool typically used at the subdivision stage of the planning process but is also appropriate for strategic planning proposals where the lot layout and/or internal road network of a proposal is already determined or where a development application proposes more than one building.

The BAL Contour is a scale map of the subject lot(s) illustrating the potential radiant heat impacts and associated indicative BAL ratings determined on the vegetation remaining within 150 metres of the assessment area after subdivision or development works are complete. Refer to Appendix B.3 for further information.

Bushfire attack level (BAL) assessment

A BAL assessment is the means of measuring the severity of a buildings' potential exposure to ember attack, radiant heat and direct flame contact using increments of radiant heat expressed in kilowatts per meter square (kW/m²)

(Table 1 and Figure 4). They form the basis for establishing the requirements for construction to improve protection of building elements from attack by bushfire.

A BAL assessment is used at the development application and the building permit stage, when the location of the building is known. Refer to Appendix B.4 for further information.

3.2.2 Bushfire management plans

Where the BHL assessment, BAL Contour or BAL assessment results in a BHL above 'Low' or a BAL rating above BAL-LOW, a bushfire management plan is required to accompany strategic planning proposals, subdivision or development applications. A bushfire management plan includes the bushfire assessment, identification of environmental constraints, identification of the bushfire hazard issues arising from the relevant assessment and a demonstration that compliance with the bushfire protection criteria, can be achieved. Further information can be found in Appendix C.

3.2.3 Addressing the bushfire protection criteria

The bushfire protection criteria are an outcomes-based system of assessing bushfire risk management measures. The bushfire protection criteria are divided across four Elements – location, siting and design, vehicular access and water supply.

Each Element is achieved by demonstrating compliance with one of the following:

- a) Acceptable solution(s)
- b) Outcomes-based approach
- c) A combination of (a) and (b).



Table 1: BAL and corresponding descriptions of the predicted levels of exposure and heat flux exposure thresholds

BAL	DESCRIPTION OF PREDICTED BUSHFIRE ATTACK AND LEVELS OF EXPOSURE Source: AS 3959-2018, Table 3.1
BAL-LOW	There is insufficient risk to warrant specific construction requirements, but there is still some risk.
BAL-12.5	There is a risk of ember attack. The construction elements are expected to be exposed to a heat flux not greater than 12.5kW/m ² .
BAL-19	Increasing levels of ember attack and burning debris ignited by windborne embers together with increasing heat flux. The construction elements are expected to be exposed to a heat flux not greater than 19kW/m ² .
BAL-29	Increasing levels of ember attack and burning debris ignited by windborne embers together with increasing heat flux. The construction elements are expected to be exposed to a heat flux not greater than 29kW/m ² .
BAL-40	Increasing levels of ember attack and burning debris ignited by windborne embers together with increasing heat flux with the increased likelihood of direct contact with flames. The construction elements are expected to be exposed to a heat flux not greater than 40kW/m ² .
BAL-Flame Zone (FZ)	Direct exposure to flames from fire front in addition to heat flux and ember attack. The construction elements are expected to be exposed to a heat flux greater than 40kW/m ² .

Acceptable solutions

The acceptable solutions provide a deemed-to-comply pathway for assessment and approval. Compliance with the relevant acceptable solutions achieves the policy outcomes and satisfy the requirements of SPP 3.7. The acceptable solutions should be achieved in the first instance as there is a level of confidence around the use and effectiveness of these criteria.

Outcomes-based approach

An outcomes-based approach can be used where compliance with the acceptable solutions cannot be achieved due to demonstrated site or environmental constraints (including waterways, where road(s) are already gazetted or existing native vegetation cannot be cleared), and where the bushfire planning practitioner is of the expert opinion that the SPP outcomes can still be demonstrated. An outcomes-based approach should be used in exceptional circumstances only.

Where an outcomes-based approach or a combination outcomes-based and acceptable solutions approach is being used, the bushfire management plan should:

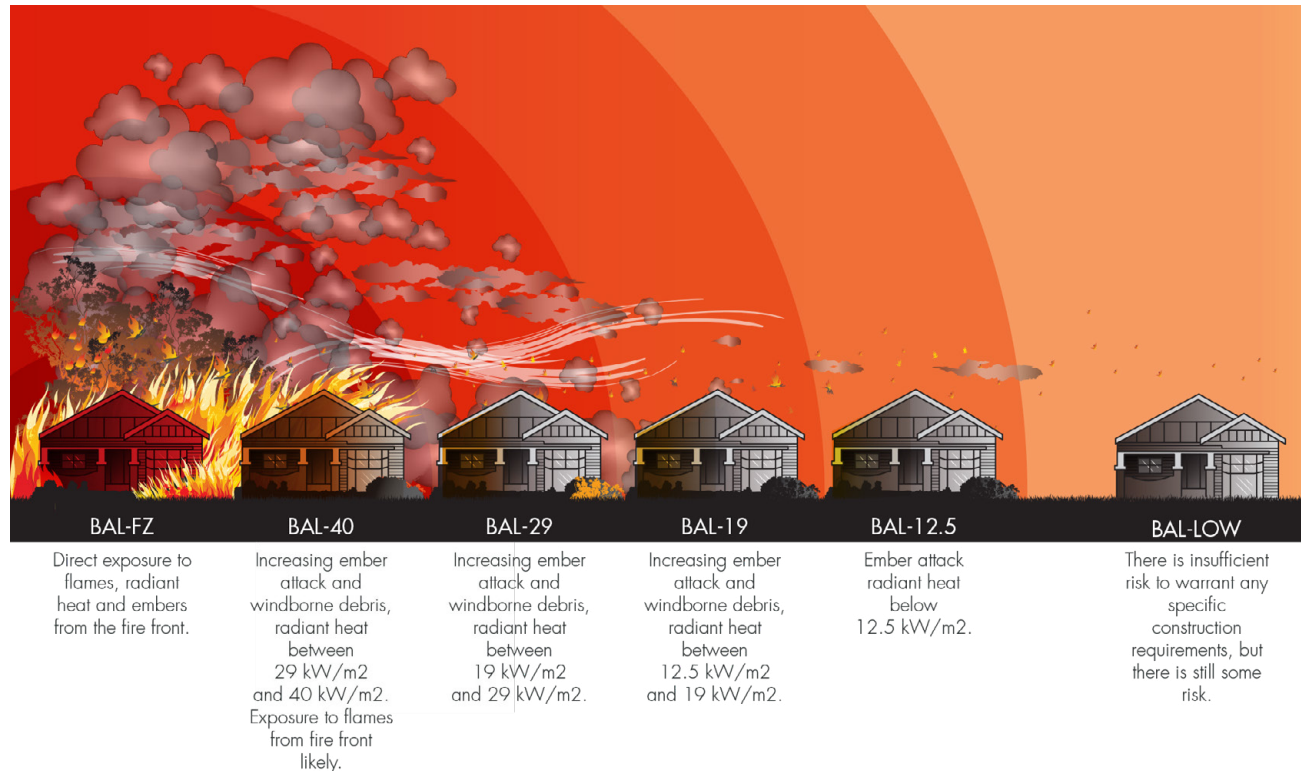
- address the acceptable solutions to the greatest extent possible
- identify the non-compliance with the acceptable solutions and why these cannot be achieved
- detail how the design considers worst-case bushfire risk and where additional bushfire risk management measures have been included to minimise the risk
- detail if there are any community net-benefits, such as improvements to the public road network
- include any Method 2 BAL assessments, fire engineering solutions or written evidence such as publications or State Administrative Tribunal decisions to support the strategic planning proposal, subdivision or development applications (where available)
- outline how the policy objectives and outcomes of SPP 3.7 have been achieved
- outline why approval is warranted by the decision-maker in this instance.

Additional bushfire risk management measures may include, but are not limited to:

- improvements to the local and broader road network to facilitate improved access, to and within the site or locality
- provision of additional emergency access ways or fire service access routes
- provision of additional strategic or private water tanks



Figure 4: BAL construction levels in context



“AS 3959 – Construction of buildings in bushfire-prone areas is developed and maintained by Standards Australia. Information on how to obtain a copy of the standard is available on the Standards Australia website at: <https://www.standards.org.au/access-standards/buy-standards>”

- a reduction in the number of lots or maximum occupancy
- an increased/additional area of public open space managed in perpetuity, in a ‘low-threat’ state, to provide increased hazard separation to any classified vegetation
- provision of additional forms of hazard separation

- construction of buildings to a higher construction standard than required under AS 3959. This higher standard is applicable for supporting the development application stage only and may, in some circumstances be above the minimum standards required by the BCA for that building.

Details on how the additional bushfire risk management measures will be implemented, are to be included in the bushfire management plan.

3.2.3 Approvals issued prior to SPP 3.7 (2023)

Where a strategic planning proposal, subdivision or development application was approved prior to 2015 and was not assessed against SPP 3.7 (2015) or the Guidelines, the subsequent stage of the planning process, or modification or addition to the development approval, should demonstrate compliance with SPP 3.7 (2023) and these Guidelines.

Where a strategic planning proposal, subdivision or development application was assessed against SPP 3.7 (2015) and the Guidelines, the subsequent stage(s) of the planning process, or modification or addition to the development approval, should demonstrate compliance with SPP 3.7 (2023) and these Guidelines, including the new methodology for Element 1: location (if required).

In these instances, and where necessary, the design should be modified to achieve compliance with the bushfire protection criteria. Where re-design is not possible due to demonstrated site and/or environmental constraints, an outcomes-based approach can be used.



4 HIGHER-ORDER STRATEGIC PLANNING DOCUMENTS

Higher-order strategic planning documents set out the long-term planning direction for an area and provide broad coordination of land use, major roads, reserves, infrastructure and community facilities, generally over one or more local government areas. Higher-order strategic planning documents include regional and sub-regional frameworks, region schemes, sub-regional strategies, district structure plans and local planning strategies.

Areas identified for intensification that are designated as Area 1 on the *Map of Bush Fire Prone Areas (Area 1)* do not require a bushfire assessment at this stage of the planning process.

Areas identified for intensification that are designated as Area 2 on the *Map of Bush Fire Prone Areas (Area 2)* should undertake the following bushfire assessment, with a focus on demonstrating Element 1: location through an assessment of the broader landscape.

4.1 DESIGN CONSIDERATIONS

Strategic planning enables holistic consideration of issues, including existing and future settlement patterns and land supply and can often ensure future land use and development are located where the bushfire risk is low and/or where the bushfire risk can be satisfactorily managed or mitigated through use of the bushfire protection criteria.

Consolidation and expansion of existing settlements with a low level of bushfire risk enable robust bushfire resilient communities. Existing settlements often provide access to services, including water, electricity, telecommunications, emergency services, medical services and an existing road network, which can provide options for evacuation. Larger settlements may also provide a suitable destination where residents can take shelter during and after a bushfire event.

Strategic planning proposals that are isolated from existing bushfire resilient communities, including but not limited to isolated rural, rural living and smaller coastal communities with limited access, present many challenges. When located in bushfire prone areas, the challenges are exacerbated. Challenges include:

- limited access to suitable destinations for evacuation purposes
- long and/or complex road patterns making access and evacuation more difficult
- limited access to services including emergency services, police and health services
- poor access to reliable communication.

Consideration of the broader landscape at this level of the planning process will ensure that development is avoided in areas that present an unacceptable bushfire risk.

Design and environmental considerations for subsequent stages of the planning process are provided in the relevant sections of the Guidelines.

4.2 INFORMATION TO ACCOMPANY A HIGHER-ORDER STRATEGIC PLANNING DOCUMENT

A strategic bushfire management plan should be prepared prior to the higher-order strategic planning document, to inform and support the recommendations of the planning document and should include the following information.

- a. the identification of any environmental, biodiversity or conservation values on the subject site that may be impacted by any proposed clearing or modification of vegetation, necessary to mitigate bushfire risk
- b. a pre-development BHL assessment that demonstrates a BHL of predominantly moderate or low. Where the pre-development BHL assessment results in areas with a predominantly extreme BHL, further detail should be provided to demonstrate that the hazard (vegetation) can be removed or modified to reduce the BHL to moderate or low
- c. an assessment of the broader landscape
- d. the identification of any bushfire hazard issues arising from the assessment
- e. evidence that the bushfire protection criteria contained within Section 5 of the Guidelines can be complied with in the subsequent planning stages.



4.2.1 Other uses for a bushfire assessment at the higher order strategic planning stage

Where the strategic planning document does not propose land use intensification in a bushfire prone area and/or does not result in an increase in bushfire risk, there is no requirement to address SPP 3.7. However, consideration could be given to using a strategic bushfire assessment to:

- reconsider the bushfire risks on land that was zoned for intensification without assessment or consideration of SPP 3.7 and/or Element 1: location, but is yet to be developed
- assess and identify improvements to increase the bushfire resilience of existing developments or communities, within bushfire prone areas. Improvements could include access arrangements, improved vegetation management on public and private lands, development of a community bushfire emergency plan
- develop a tourism strategy to guide the location and development of various tourism land uses within bushfire prone areas
- identify suitable buildings or open space areas that could be used to provide shelter in the event of a bushfire as a last resort option when evacuation is no longer available. This could form part of improvements for existing communities, particularly for communities with limited access and egress, such as coastal communities, or form part of a tourism strategy.

4.3 SYNERGIES WITH EXISTING LOCAL GOVERNMENT BUSHFIRE DOCUMENTATION

There may be opportunities to align the strategic bushfire management plan with existing State or local government bushfire preparation/policy documentation, such as the local government's Bushfire Risk Management Plan (BRMP). BRMPs provide local governments with an integrated bushfire risk management framework for their local area and contain a written plan, a communications strategy, an asset risk register and a treatment schedule. Any strategic risk assessments undertaken to inform the BRMP may be particularly useful in understanding the bushfire issues affecting the local government area.

RELEVANT SUPPORTING INFORMATION

- > **Appendix A – Bushfire Protection Criteria explanatory notes**
 - A.1 Location**
 - A.2 Siting and design**
 - A.3 Vehicular Access**
 - A.4 Water supply**
- > **Appendix B – Bushfire Assessment Methodologies**
 - B.1 Broader landscape assessment**
 - B.2 Bushfire Hazard Level**
- > **Appendix C – A guide to developing a bushfire management plan**
- > **Fact Sheet – Bushfire and Vegetation.**



5 STRATEGIC PLANNING PROPOSALS

Strategic planning proposals include local planning schemes, scheme amendments, and structure plans where the lot layout and/or internal road network is not known.

Areas identified for intensification and/or result in an increase in bushfire risk, which are within an area designated as Area 1, do not require a bushfire assessment at this stage of the planning process.

Areas identified for intensification and/or result in an increase in bushfire risk, which are within an area designated as Area 2 are required to address SPP 3.7 and the Guidelines.

A scheme amendment that includes sufficient detail on internal vehicular access and development or lot layout, may be best assessed against Section 6 – Structure plans and subdivisions.

A scheme amendment to facilitate a vulnerable land use should refer to the requirements and bushfire protection criteria within Section 8 – Development: Commercial, industrial and community uses or Section 9 – Vulnerable tourism land uses.

5.1 DESIGN CONSIDERATIONS

5.1.1 Location

Consolidation and expansion of existing settlements with a low level of bushfire risk support robust bushfire resilient communities. Existing settlements often provide access to services, including water, electricity, telecommunications, emergency services, medical services and an existing road network, which can provide options for evacuation. Larger settlements may also provide a suitable destination within the settlement, where residents can take shelter during and after a bushfire event.

Strategic planning proposals that are isolated from existing bushfire resilient communities, including but not limited to isolated rural, rural living and smaller inland or coastal communities with limited access, present many challenges. When located in bushfire prone areas the challenges are exacerbated. Challenges include:

- limited access to suitable destinations for evacuation purposes
- long and/or complex road patterns making access and evacuation more difficult
- limited access to services including emergency services, police and health services
- poor access to reliable communication.

Consideration of the broader landscape at this level of the planning process will provide an extra level of detail to ensure that development is avoided in areas that present an unacceptable bushfire risk.

5.1.2 Hazard separation

On-site bushfire hazards such as large areas of retained native vegetation can result in a bushfire entering and running through the site, especially when adjoining areas of classified vegetation beyond the subject site. At the strategic planning stage hazard separation should be identified to demonstrate that separation can be achieved between proposed lots and the adjoining classified vegetation, and/or to provide separation between classified vegetation and proposed lots within the subject site. Hazard separation could include the following:

- public perimeter roads
- public roads, fire service access routes or emergency accessways
- public open space, including recreational areas, exempt vegetation or vegetation managed in a low threat state in accordance with Clause 2.2.3.2 of AS 3959
- water bodies, including lakes, ponds or dams and managed water retention areas
- hard surfaces such as driveways, tennis courts or sports areas and footpaths.

Design and environmental considerations for subsequent stages of the planning process are provided in the relevant sections of the Guidelines.



5.2 INFORMATION TO ACCOMPANY A STRATEGIC PLANNING PROPOSAL

Portions of land that are within Area 2 and propose an intensification of land use, or increase in the bushfire risk, require:

- a) the identification of any environmental, biodiversity or conservation values on the subject site that may be impacted by any proposed clearing or modification of vegetation, necessary to mitigate bushfire risk
- b) a pre-development BHL assessment that demonstrates a BHL of predominantly moderate or low. Where the pre-development BHL assessment results in areas with a predominantly extreme BHL, further detail should be provided to demonstrate that the hazard (vegetation) can be removed or modified to reduce the BHL to moderate or low
- c) an assessment of the broader landscape
- d) the identification of any bushfire hazard issues arising from the assessment
- e) assessment against the bushfire protection criteria, demonstrating compliance via either the acceptable solutions, or through an outcomes-based approach.

This information should be provided in the form of a bushfire management plan.

RELEVANT SUPPORTING INFORMATION

- > **Appendix A – Bushfire Protection Criteria explanatory notes**
 - A.1 Location**
 - A.2 Siting and design**
 - A.3 Vehicular Access**
 - A.4 Water supply**
- > **Appendix B – Bushfire Assessment Methodologies**
 - B.1 Broader landscape assessment**
 - B.2 Bushfire Hazard Level**
- > **Appendix C – A guide to developing a bushfire management plan**
- > **Fact Sheet – Bushfire and Vegetation.**



BPC 5: Bushfire protection criteria for strategic planning proposals

ELEMENT 1: LOCATION – STRATEGIC PLANNING PROPOSALS

SPP 3.7 OUTCOMES

ACCEPTABLE SOLUTIONS

O1 Avoid broader landscapes that present an unacceptable bushfire risk to life, property and infrastructure

Determine the Broader Landscape Type in accordance with Appendix B.1. Then proceed under A1.1, A1.2 or A1.3.

A1.1 Broader Landscape Type A

The strategic planning proposal is located in an area that is a Broader Landscape Type A – no additional landscape consideration is required.

A1.2 Broader Landscape Type B

Where a strategic planning proposal is located in an area that is a Broader Landscape Type B, it should be demonstrated that:

- The risks presented by the broader landscape can be mitigated to an acceptable level, using the bushfire protection criteria contained in Elements 2 – 4 or any additional mitigation measures; and
- The planning proposal maintains or improves the evacuation capacity of the road network in the event of a bushfire and does not make the current situation worse; and
- Evacuation to a suitable destination in the event of a bushfire can be achieved.

A1.3 Broader Landscape Type C

Strategic planning proposals located in an area that is a Broader Landscape Type C present an unacceptable bushfire risk and the intensification of land use or development should be avoided. For strategic planning proposals to be further considered an outcomes-based approach, for Element 1 in accordance with policy measure 7.4 of SPP 3.7 can be undertaken.

ELEMENT 2: SITING AND DESIGN

SPP 3.7 OUTCOMES

ACCEPTABLE SOLUTIONS

O2 Ensure siting and design solutions minimise environmental degradation and manage the bushfire risk to people, property and infrastructure

A2.1 Siting and design

The areas of the subject site(s) identified for intensification and/or the future development site(s) achieve a pre- or post-development bushfire hazard level of moderate or low.

A2.2 Hazard separation

Hazard separation is identified, between areas of classified vegetation under AS:3959 and the areas of the subject site(s) identified for intensification and/or the future development site(s).



ELEMENT 3: VEHICULAR ACCESS – STRATEGIC PLANNING PROPOSALS

SPP 3.7 OUTCOMES

ACCEPTABLE SOLUTIONS

O3 Ensure the design and capacity of vehicular access and egress provide for efficient and effective evacuation

A3.1 Public roads

Public roads, including perimeter roads should meet the technical requirements in Appendix A.3, Table 4.

A3.2 Access routes

Public road access should be provided in two different directions, to two different suitable destinations; and with an all-weather surface.

A3.3 No-through roads

A 3.3a If the public road access to the subject site is via a no-through road which cannot be avoided due to demonstrated site constraints, the public road access is to be a maximum of 200 m from the proposed lot(s) boundary to an intersection where two-way access is provided.

The no-through road may exceed 200 m if it is demonstrated that an alternative access, including an emergency access way, cannot be provided due to site constraints and the following requirements are met:

- the no-through road travels towards a suitable destination; and
- the balance of the no-through road, that is greater than 200 m from the subject site, is wholly within BAL-LOW, or is within a residential built-out area or within Area 1 (Figure 13).

A3.3b A no-through road is to meet all the following requirements:

- requirements of a public road (Appendix A.3, Table 4, Column 2); and
- turn-around area/head (Figure 14).

ELEMENT 4: WATER SUPPLY – STRATEGIC PLANNING PROPOSALS

SPP 3.7 OUTCOMES

ACCEPTABLE SOLUTIONS

Not applicable

A4.1 Water supply

Evidence that a sufficient and accessible reticulated or non-reticulated water supply for bushfire firefighting can be provided at the subdivision and/or development application stage, in accordance with the specifications of the relevant water supply authority or the requirements in Appendix A.4 – Water dedicated for bushfire firefighting.



6 STRUCTURE PLANS (WHERE THE LOT LAYOUT AND/OR INTERNAL ROAD NETWORK IS KNOWN) AND SUBDIVISION APPLICATIONS

A structure plan is for the coordination of future subdivision, zoning and where relevant, development. Local structure plans are generally prepared by either the landowner, their proponent or the local government. They are approved by the WAPC in consultation with the local government and relevant agencies. Any subdivision application for the site should have due regard to an approved structure plan.

Subdivision applications are lodged with, and determined by, the WAPC in consultation with the local government and relevant agencies

6.1 INFILL (RESIDENTIAL) SUBDIVISION WITHIN AREA 1 ON THE MAP OF BUSH FIRE PRONE AREAS

Increasing density within our urban areas is important to curb urban sprawl and create more sustainable cities. It is anticipated that subdivisions proposing four or more lots for residential purposes, often have more flexibility with design and can achieve the necessary requirements, including a development site(s) within an area of 29 kW/m² (BAL-29) or below. On this basis, an assessment against the bushfire protection criteria within this Section of the Guidelines is required.

However, subdivision applications proposing fewer than four lots, for smaller residential lots the achievement of lot(s) with a development site within an area of 29 kW/m² (BAL-29) or below, becomes more challenging. If the adjoining land is not considered to be low threat under the exemptions of AS 3959 and is not able to be managed to be low threat, such as a vegetated reserve or an area of public open space, often the result is a 40 kW/m² (BAL-40) or BAL-FZ rating for part of the lot or development site.

Applications for the subdivision of up to and including three residential lots (or three residential lots and one common property access lot), that are fully contained within Area 1, should be assessed against the bushfire protection criteria within Section 7 - Development - Residential of the Guidelines. This provides a pathway for consideration of lots within 40 kW/m² (BAL-40) or above.

6.2 DESIGN CONSIDERATIONS

Note: A structure plan or subdivision may need to incorporate design principles contained within other WAPC policies, such as Liveable Neighbourhoods and the Design WA policy suite, where applicable, in addition to these Guidelines.

The siting, layout and design of a structure plan or subdivision should respond to the bushfire risk presented by the interface with vegetation, classified under AS 3959, adjoining the subject site and any remaining or proposed classified vegetation within the site. Hazard separation should be included between proposed lots and classified vegetation, on adjoining land, and/or to provide separation between classified vegetation remaining within the subject site and proposed lots. Hazard separation includes but is not limited to:

- public perimeter roads
- public roads, fire service access routes or emergency accessways
- public open space, including recreational areas, excluded or managed in a low threat state in accordance with Clause 2.2.3.2 of AS 3959
- water bodies, including lakes, ponds or dams and managed water retention areas
- hard surfaces such as driveways, tennis courts or sports areas and footpaths.



The design and location of new areas of public open space, revegetation and any existing or proposed vegetation corridors, both within the subject site and connecting to vegetation in the surrounding landscape, should be planned to minimise fuel continuity that may enable a bushfire to enter and run through the subject site.

Areas of public land, including public open space and urban water management areas, can assist in mitigating bushfire risk, if they are excluded or managed as low threat vegetation in accordance with Clause 2.2.3.2 of AS 3959. Examples of low threat open space include maintained lawns, golf courses, public recreation reserves and parklands. The proponent should obtain written support from the land manager for the ongoing management of the vegetation in perpetuity and include this with the bushfire management plan.

There is no obligation for land managers to maintain vegetation in a low threat state and, where no agreement is made, proponents should be aware that the vegetation classification should reflect the future mature state of the vegetation.

Undeveloped future stages of the subdivision, containing classified vegetation, will also need to be taken into consideration. Even if the hazard will be cleared at a subsequent stage, until this occurs, subdivision of adjoining lots must address this risk in its future mature state.

Integration of water-sensitive urban design measures to retain water within public land can be a useful design response in bushfire mitigation. Where a landscape management plan or water management report proposes to re-vegetate a site to manage stormwater, the BAL

assessment should consider the future mature state of the vegetation. It is important to link bushfire management plans with landscape and urban water management plans.

Careful plant selection may assist with both water and bushfire risk management. Management of vegetation in a low threat state and careful species selection may be used to manage transitional areas, where an ecological link or buffer area is required to be vegetated.

6.2.1 Existing habitable buildings

Where any habitable building(s) exists on a lot that is subject to a subdivision application, the construction standard of the existing habitable building(s) is not required to be upgraded or modified. However, the bushfire management plan should demonstrate that each lot can achieve a development site within an area subject to 29 kW/m² or lower, irrespective of whether the

Figure 5: Subdivision and development design





existing habitable building is within this area. Where an Asset Protection Zone (APZ) is necessary to achieve 29 kW/m² or lower, the APZ should be within the boundaries of the lot(s). This will ensure that if the existing habitable building(s) is demolished, a new habitable building(s) can achieve a 29 kW/m² (BAL-29) or lower. The lot containing the existing habitable building(s) should also comply with the acceptable solutions for Element 3: vehicular access and Element 4: water supply, as outlined in Section 7 - Development - Residential.

6.2.2 Environmental considerations

Topography has a direct correlation to rate of spread of a bushfire and should be considered when designing a structure plan or subdivision, identifying development sites or when introducing vegetation or regenerating existing vegetation. Ridge tops, crests, narrow gullies and steep slopes (Figure 6) are particularly dangerous in a bushfire, as fire can accelerate in these areas and convection patterns with high wind speed can cause unpredictable movements of fire spread over a landscape.

It is recommended that development be located on flat areas or slopes less than 10 degrees (especially where classified vegetation is located downslope to a building) and away from ridge tops, crests or narrow gullies.

Circumstances where these locations may be suitable for development to occur include where the land is already cleared, and 29 kW/m² or lower can be achieved for the whole development site without the use of an APZ. To ensure soil stability within an APZ, vegetation removal on slopes exceeding 18 degrees is discouraged.

New development and associated APZ should be located in existing cleared areas wherever possible to minimise exposure to the bushfire hazard and avoid the need for

Figure 6: Topography considerations for building locations



further vegetation removal or modification. The bushfire management plan should demonstrate that the proposed APZ has minimised the unnecessary loss of vegetation or potential for conflict with landscape or environmental objectives and complies with environmental approvals/exemptions (where necessary). Where loss of vegetation is not acceptable or causes conflict with landscape or environmental objectives, it may be necessary to reduce lot yield, cluster the development or modify the development location to minimise the removal or modification of native vegetation.

Where revegetation of waterway foreshores, wetland or coastal buffers is required for their protection or management, it may be necessary to modify the development location or reduce lot yield to provide

adequate hazard separation from the future boundary of the proposed revegetation. The BAL Contour Map should classify the revegetation based on its future mature state.

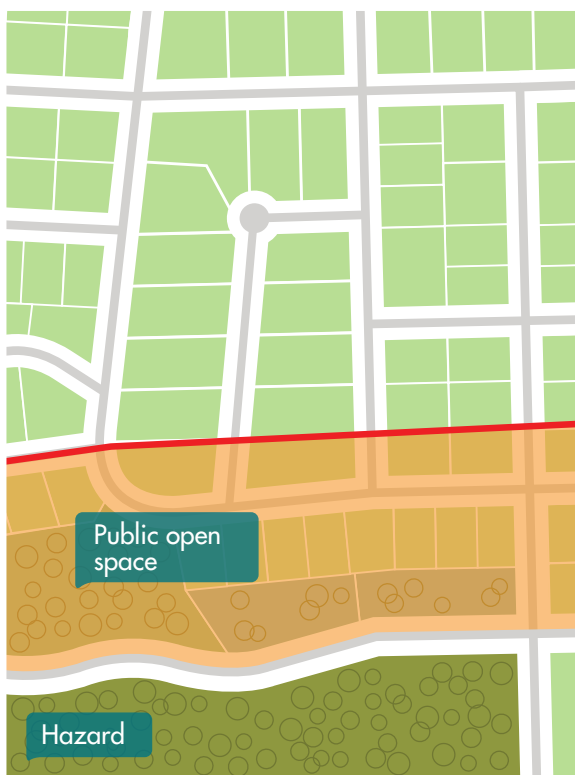
6.3 INFORMATION TO ACCOMPANY A STRUCTURE PLAN OR SUBDIVISION APPLICATION

A BAL Contour Map that indicates the post-development BAL ratings should be prepared for the proposed lot(s) within structure plans or subdivision applications that are designated as Area 1 or Area 2 (Figure 7).

Areas of the structure plan or subdivision application that are not designated as bushfire prone are not required to address SPP 3.7 or the Guidelines. However, consideration



Figure 7: Structure plan where the SPP applies to the proposed lots designated as bushfire fire prone on the Map



- lots designated as bushfire prone
- where State Planning Policy 3.7 and associated Guidelines apply

should be given to whether the wider road network can provide for the efficient and effective evacuation of the entire community.

If the BAL Contour Map indicates that any of the proposed lots will have a BAL rating above BAL-LOW, the following should accompany the subdivision application or structure plan:

- a. the identification of any environmental, biodiversity or conservation values on the subject site that may be impacted by any proposed clearing or modification of vegetation, necessary to mitigate bushfire risk
- b. a BAL Contour Map
- c. an assessment of the broader landscape for those areas designated as Area 2 on the Map of Bushfire Prone Areas
- d. the identification of any bushfire hazard issues arising from the assessment
- e. assessment against the bushfire protection criteria demonstrating compliance via either the acceptable solutions, or through an outcomes-based approach.

This information should be provided in the form of a bushfire management plan.

6.4 BUSHFIRE SUBDIVISION CONDITIONS

The WAPC has a Model Subdivision Conditions Schedule, which is a set of model conditions and advice notes that are applied to subdivision approvals consistently across the State. The Schedule includes recommended subdivision conditions that may be imposed when the application is located within a bushfire prone area and with a BAL rating of BAL-12.5 or above.

The WAPC will determine the appropriate subdivision conditions on advice from relevant referral agencies. The bushfire planning practitioner does not need to include reference to conditions within the bushfire management plan.

6.5 COMPLIANCE CERTIFICATE FOR SUBDIVISION

Where a BAL Contour Map includes BAL ratings that are based on future site works, such as clearing and modification of vegetation, the subdivision approval may be conditioned to require the preparation of a compliance certificate. After the site works have been completed, the certificate may be issued to certify that the BAL ratings shown on the BAL Contour Map, remain accurate and compliant. This will allow decision-makers to have confidence that the BALs indicated in the BAL Contour Map are accurate and able to be used to support a future development or building permit application.

It is strongly recommended that the compliance certificate be undertaken by the bushfire planning practitioner who prepared the original BAL Contour Map, or alternatively any other accredited Level 2 or Level 3 bushfire planning practitioner. The relevant local government may be able to undertake this compliance check as part of the clearance of subdivision conditions.

For larger lots, such as a rural property, where the location of a development site may not be known, the use of a compliance certificate may not be appropriate. In this instance it is likely that a new BAL assessment will be required to support a building permit.



6.6 STAGED SUBDIVISION

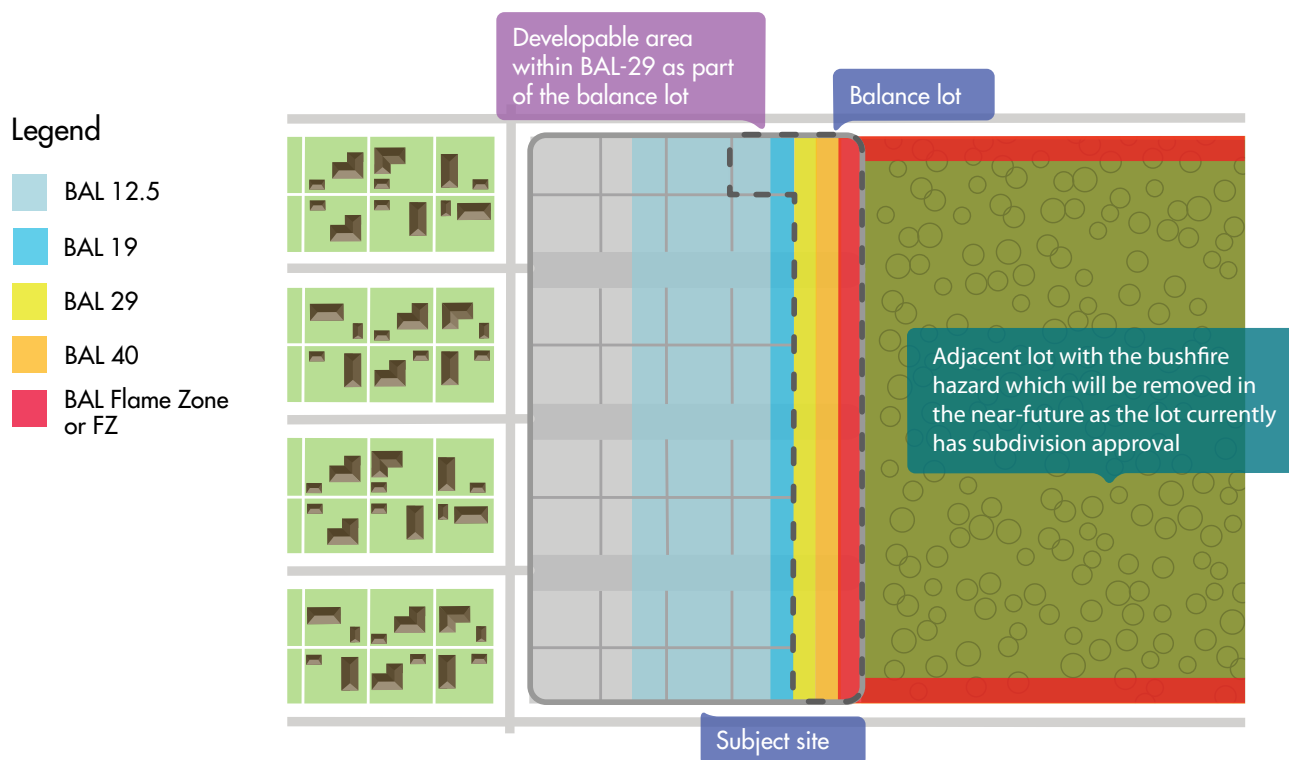
Where a subdivision proposes development in stages, the bushfire management plan should demonstrate that each stage can comply with the bushfire protection criteria.

Where public road access is required in two different directions to two different suitable destinations, these should be constructed in the first stage of subdivision. It should be demonstrated that each subsequent stage can achieve the necessary two access routes.

Classified vegetation within a subsequent stage of a subdivision may require removal or modification to ensure that proposed lots within the current stage of the subdivision achieve a development site of 29 kW/m² or below. The responsibility for the ongoing management at each stage of subdivision should be clearly defined within the implementation section of the bushfire management plan.

A proposed lot(s), the subject of the application, may abut an adjoining lot that has an approved structure plan or subdivision that is yet to be developed and still contains classifiable vegetation. The classifiable vegetation may result in a 40 kW/m² (BAL-40) or BAL-FZ on the proposed lot(s), with no development site suitable for development within 29 kW/m² or below. It is suggested that in these circumstances, the affected proposed lot(s) be created as a single balance lot until the adjoining classified vegetation is removed or modified and the proposed lot(s) can achieve a development site of 29 kW/m² or below (Figure 8). This may require the lodgement of a subsequent subdivision application, with a revised bushfire management plan.

Figure 8: Example of creating a balance lot in BAL-40/FZ that can be further subdivided when the adjacent land is developed and the bushfire hazard is removed



RELEVANT SUPPORTING INFORMATION

- > **Appendix A – Bushfire Protection Criteria explanatory notes**
 - A.1 Location
 - A.2 Siting and design
 - A.3 Vehicular Access
 - A.4 Water supply
- > **Appendix B – Bushfire Assessment Methodologies**
 - B.1 Broader landscape assessment
 - B.2 Bushfire Hazard Level
- > **Appendix C – A guide to developing a bushfire management plan**
- > **Fact Sheet – Bushfire and Vegetation.**



BPC 6: Bushfire protection criteria for structure plans (where the lot layout and/or internal road network is known) and subdivision applications

ELEMENT 1: LOCATION – STRUCTURE PLANS (LOT LAYOUT AND/OR INTERNAL ROAD NETWORK IS KNOWN) AND SUBDIVISION APPLICATIONS

SPP 3.7 OUTCOMES

ACCEPTABLE SOLUTIONS

O1 Avoid broader landscapes that present an unacceptable bushfire risk to life, property and infrastructure

Area 1: Not applicable.

Area 2: Determine the Broader Landscape Type in accordance with Appendix B.1. Then proceed under A1.1, A1.2 or A1.3.

A1.1 Broader Landscape Type A

The structure plan or subdivision is located in an area that is a Broader Landscape Type A – no additional landscape consideration is required.

A1.2 Broader Landscape Type B

Where a structure plan or subdivision is located in an area that is a Broader Landscape Type B, it should be demonstrated that:

- The risks presented by the broader landscape can be mitigated to an acceptable level, using the bushfire protection criteria contained in Elements 2 – 4 or any additional mitigation measures; and
- The structure plan or subdivision maintains or improves the evacuation capacity of the road network in the event of a bushfire and does not make the current situation worse; and
- Evacuation to a suitable destination in the event of a bushfire can be achieved.

A1.3 Broader Landscape Type C

Structure plans and subdivisions located in an area that is a Broader Landscape Type C present an unacceptable bushfire risk and the intensification of land use or development should be avoided. For strategic planning proposals to be further considered an outcomes-based approach, for element 1 in accordance with policy measure 7.4 of SPP 3.7.

ELEMENT 2: SITING AND DESIGN – STRUCTURE PLANS (LOT LAYOUT AND/OR INTERNAL ROAD NETWORK IS KNOWN) AND SUBDIVISION APPLICATIONS

SPP 3.7 OUTCOMES

ACCEPTABLE SOLUTIONS

O2 Ensure siting and design solutions minimise environmental degradation and manage the bushfire risk to people, property and infrastructure

A2.1 Siting and design

Ensure that each proposed and existing lot contains a development site(s) that achieves a radiant heat level of 29 kW/m² (BAL-29) or below.

A2.2 Hazard separation

Hazard separation is identified on the structure plan and/or subdivision, between areas of classified vegetation under AS 3959 and the development site.



A2.3 Asset Protection Zone (APZ)

Where a development site cannot be wholly located within an area of 29 kW/m² (BAL-29) or below in its pre-development state, an indicative APZ is to be provided and meet the following requirements:

- **Width:** the APZ is to be measured from the development site, and of sufficient size to ensure the potential radiant heat impact of a bushfire does not exceed 29 kW/m² (BAL-29) in all circumstances.
- **Location:** the APZ is to be contained solely within the boundaries of the lot, except in instances where:
 - the vegetation on the adjoining lot(s) is managed in a low threat state as per Clause 2.2.3.2 of AS 3959 or the requirements of Appendix A.2, Table 3 - APZ technical requirements, or an alternative standard in a gazetted local planning scheme, on an ongoing basis in perpetuity; or
 - the adjoining land is already in a minimal fuel condition, in perpetuity, such as a sealed or unsealed road, or a water body.
- **Management:** the APZ is managed in accordance with the requirements of Appendix A.2, Table 3 – APZ technical requirements, or in accordance with the local government APZ standards set out in a section 33 notice under the *Bush Fires Act 1954* (local firebreak notice), or an alternative standard in a gazetted local planning scheme.

ELEMENT 3: VEHICULAR ACCESS – STRUCTURE PLANS (LOT LAYOUT AND/OR INTERNAL ROAD ACCESS IS KNOWN) AND SUBDIVISION APPLICATIONS

SPP 3.7 OUTCOMES

ACCEPTABLE SOLUTIONS

O3 Ensure the design and capacity of vehicular access and egress provide for efficient and effective evacuation

A3.1 Public roads

Public roads are to meet the technical requirements in Appendix A.3, Table 4.

A3.2 Access routes

Area 1: Public road access is to be provided to at least one suitable destination.

Area 2: Public road access should be provided in two different directions to two different suitable destinations, with an all-weather surface.



A3.3 No-through roads

A3.3a **Area 1: No limitation on no-through road lengths.**

Area 2: If the public road access to the subject site is via a no-through road which cannot be avoided due to demonstrated site constraints, the public road access is to be a maximum of 200 m from the proposed lot(s) boundary to an intersection where two-way access is provided.

The no-through road may exceed 200 m if it is demonstrated that an alternative access, including an emergency access way, cannot be provided due to site constraints and the following requirements are met:

- the no-through road travels towards a suitable destination; and
- the balance of the no-through road, that is greater than 200 m from the subject site, is wholly within BAL-LOW, or is within a residential built-out area, or is within Area 1 (Figure 13).

A3.3b A no-through road is to meet all the following requirements:

- requirements of a public road (Appendix A.3, Table 4, Column 2); and
- turn-around area/head (Figure 14).

A3.4 Emergency access way

Where it is demonstrated that A3.2 and A3.3 cannot be achieved due to site constraints or where an alternative design option does not exist, an emergency access way can be considered as an acceptable solution.

An emergency access way is to meet all the following requirements:

- requirements in Appendix A.3, Table 4, Column 3;
- provides a through connection to a public road;
- be no more than 500 m in length; and
- must be signposted and if gated, gates must open for the whole trafficable width and remain unlocked.

A3.5a Perimeter roads

A perimeter road is a public road and is to be provided for greenfield or infill development where 10 or more lots are proposed (including as part of a staged subdivision) with the aim of:

- separating areas of classified vegetation under AS 3959 which adjoin the subject site, from the proposed lot(s); and
- removing the need for battle-axe lots that back onto areas of classified vegetation.

A perimeter road is to meet the requirements contained in Appendix A.3, Table 4, Column 1.

A perimeter road may not be required where:

- the adjoining classified vegetation is Class G Grassland;
- lots are zoned for rural living or equivalent;
- it is demonstrated that it cannot be provided due to site constraints; or
- all lots have frontage to an existing public road.



A3.5b Fire service access route

Where proposed lots adjoin classified vegetation under AS 3959 (excluding Class G Grassland), and a perimeter road is not required in accordance with A3.5a, a fire service access route can be considered as an acceptable solution to provide firefighter access, where access is not available to the classified vegetation.

A fire service access route is to meet all the following requirements:

- requirements of Appendix A.3, Table 4, Column 4;
- be through-routes with no dead-ends;
- must be signposted;
- no further than 500 m from a public road; and
- if gated, gates must open the whole trafficable width and can be locked by the local government and/or the emergency services, if keys are provided for each gate.

A3.6 Battle-axe access legs

Where it is demonstrated that a battle-axe access leg cannot be avoided due to site or design constraints, it can be considered as an acceptable solution.

There are no battle-axe technical requirements where the point of the battle-axe access leg joins the effective area of the battle-axe lot, is less than 50 m from a public road in a reticulated water area.

In circumstances where the above acceptable solution is not met, or the battle-axe lot is in a non-reticulated water area, the battle-axe leg is to meet all the following requirements:

- requirements in Appendix A.3, Table 4, Column 5; and
- passing bays every 200 m with a minimum length of 20 m and a minimum additional trafficable width of two metres (i.e. the combined trafficable width of the passing bay and constructed private driveway to be a minimum six metres).
- turn-around area/head (Figure 14).

ELEMENT 4: WATER SUPPLY – STRUCTURE PLANS (LOT LAYOUT AND/OR INTERNAL ROAD ACCESS IS KNOWN) AND SUBDIVISION APPLICATIONS

SPP 3.7 OUTCOMES

ACCEPTABLE SOLUTIONS

P4 Ensure that sufficient water is available to enable people, property and infrastructure to be defended from bushfire

A4.1 Water supply for structure plans

Evidence that a reticulated or sufficient and sustainable non-reticulated water supply for bushfire firefighting can be provided at the subdivision and/or development application stage, in accordance with the specifications of the relevant water supply authority or the requirements in Appendix A.4 - Water supply dedicated for bushfire firefighting.

Where the provision of a strategic water tank(s) is required, a suitable area identified as a Crown reserve should be identified on the structure plan, to the satisfaction of the WAPC on advice from the local government.



A4.2 Water supply for subdivision applications

Where a reticulated water supply is existing or proposed, a hydrant connection(s) should be provided in accordance with the specifications of the relevant water supply authority.

Where these specifications cannot be met, then the following applies:

- the provision of a water tank(s) in accordance with the requirements of Appendix A.4, Table 5 – Water supply dedicated for bushfire firefighting; and
- where the provision of a strategic water tank(s) is applicable, then the following requirements apply:
 - land to be ceded free of cost to Crown for the placement of the tank(s);
 - the proposed reserve where the tank is to be located is identified on the plan of subdivision;
 - tank capacity, construction and fittings, provided in accordance with the requirements of Appendix A.4; and
 - a strategic water tank is to be located no more than a 10-minute drive from the furthest development site (at legal road speeds).

A4.3 Water supply for existing habitable building(s)

Where subdivision includes an existing habitable building(s) that is to be retained, a hydrant connection(s) should be provided in accordance with the specifications of the relevant water supply authority.

Where these specifications cannot be met, a water tank(s) should be provided in accordance with the requirements of Appendix A.4, Table 5 – Water supply dedicated for bushfire firefighting



7 DEVELOPMENT - RESIDENTIAL

The following application types should address the requirements within this Section:

- An application for the development of, or additions to, a habitable building for residential purposes, including a single house, ancillary dwelling, grouped dwelling, multiple dwelling or mixed-use development
- An application for infill subdivision or strata subdivision of up to and including three residential lots (or three residential lots and one common property access lot), within Area 1.

Refer to Section 1.2 How the Guidelines apply for further information on when to apply SPP 3.7 and the Guidelines, and the LPS Regulations 2015.

7.1 DESIGN CONSIDERATIONS

The siting of development should respond to the bushfire risk presented by the interface with classified vegetation from land adjoining the subject site and any remaining or proposed classified vegetation within the subject site. Asset Protection Zones (APZs) are commonly used to mitigate the bushfire threat within a lot. Strategic management of vegetation and plant flammability within the APZ should be considered in accordance with Appendix A.2. Where possible, development should be in existing cleared area(s) to reduce the need for modification or removal of vegetation.

Topography has a direct correlation to rate of spread of a bushfire and should be considered when identifying development sites or when introducing vegetation or

regenerating existing vegetation. Ridge tops, crests, narrow gullies and steep slopes (Figure 6) often provide amenity and scenic views over a landscape, but are particularly dangerous in a bushfire, as fire can accelerate in these areas.

Although topography and existing cleared areas often compete with other planning considerations, where there is opportunity, the development site should be selected to reduce the bushfire threat.

Where possible, private driveways should provide a line of sight to the public road, to aid access by emergency services.

A helpful guide that may assist with siting, design and construction of new development is the Bushfire Resilient Building Guidance for Queensland Homes developed by the Queensland Government in collaboration with the CSIRO. [You can find the document here.](#)

7.1.1 Building envelopes

Where building envelopes are a requirement of a local planning scheme and an APZ is necessary to achieve 29 kW/m² (BAL-29) or below for a habitable building, the APZ should be accommodated within the building envelope. It is not necessary for the entire building envelope to achieve 29 kW/m² (BAL-29) as this could potentially lead to unnecessary clearing or modification of vegetation.

7.2 DEVELOPMENT SITES WITHIN BAL-40 OR BAL-FZ

Development sites and habitable buildings within 40 kW/m² (BAL-40) or BAL-FZ are likely to have direct exposure to flame contact, as well as radiant heat impact

in excess of 40 kW/m² and be subject to ember attack. Bushfire research has found that the separation distance between a structure and classified vegetation is a good indicator of the likelihood of damage by fire, with a clear trend towards greater total loss as the separation distance between vegetation and building decreases. This research identified that even where houses have been constructed to flame zone construction standards, house loss is still occurring.

7.2.1 Habitable buildings (residential)

There are occasions where a lot(s) has been created prior to implementation of SPP 3.7 and the Guidelines in December 2015 and due to site and/or environmental constraints, a habitable building is unable to be located within an area of 29 kW/m² (BAL-29) or below. SPP 3.7 and the Guidelines recognise the expectation to be able to build a residential habitable building on a lot that is zoned for this purpose and as such provides a pathway for the consideration of siting within areas subject to 40 kW/m² (BAL-40) or BAL-FZ in exceptional circumstances.

Clause 78D(3) of the LPS Regulations require a development application and a bushfire management plan where a development site is proposed within 40 kW/m² (BAL-40) or BAL-FZ.

7.2.2 Infill (residential) subdivision within areas designated Area 1 on the Map of Bush Fire Prone Areas

Where vegetation on land adjoining a lot is not deemed to be low threat under AS 3959 and is not able to be managed to low threat, such as a vegetated reserve or an area of public open space, often the result is a radiant heat impact of 40 kW/m² or above for the development site.



To facilitate an increase in density within areas designated as Area 1, consideration can be given to the creation of up to and including three residential lots (or three residential lots and one common property access lot), with a development site(s) with a radiant heat impact of 40kW/m² or above. Subdivision applications should be assessed against the bushfire protection criteria within this Section of the Guidelines. This provides a pathway for consideration of lots within 40 kW/m² or above.

The decision-maker should be satisfied that the bushfire protection criteria for A2.1b Siting within 40 kW/m² (BAL-40) and/or more than 40 kW/m² (BAL-FZ) of Section 7 (below), and the additional criteria contained within policy measure 7.4 ii of SPP 3.7, have been met. A notification on title is required to advise future owners of the hazard and the requirement to build to the appropriate bushfire construction standard in accordance with the BCA.

7.3 INFORMATION TO ACCOMPANY THE DEVELOPMENT APPLICATION OR SUBDIVISION

A BAL assessment or BAL Contour Map should be prepared. Subdivision applications, and development applications that propose multiple habitable buildings, should submit a BAL Contour Map, instead of a BAL assessment.

Where a BAL Contour Map was prepared as part of the subdivision and/or structure plan, a compliance certificate should be provided to confirm that, following completion of the subdivision works, the indicative BAL remains accurate. The BAL Contour Map and compliance certificate can be used for the purpose of the development application.

If the BAL assessment or BAL Contour Map indicates that the proposed development site(s) or habitable building(s) will have a BAL rating above BAL-LOW, a bushfire management plan should accompany the development application and include the following information:

- a. the identification of any environmental, biodiversity or conservation values on the subject site that may be impacted by any proposed clearing or modification of vegetation, necessary to mitigate bushfire risk
- b. a BAL Contour Map or BAL assessment
- d. the identification of any bushfire hazard issues arising from the assessment
- e. assessment against the bushfire protection criteria, demonstrating compliance via either the acceptable solutions, or through an outcomes-based approach.

Additional information:

Where a proposed habitable building(s) or development site(s) is within 40 kW/m² (BAL-40) or above (BAL-FZ), the bushfire management plan should include additional information in accordance with policy measure 7.4 ii of SPP 3.7.

7.3.1 BAL assessment (basic)

A BAL assessment (basic) is prepared for the development application where the development site is within a designated bushfire prone area but there is no apparent bushfire risk to the development site from vegetation classified under AS 3959, as Class A: Forest, Class B: Woodland, Class C: Shrubland or Class D: Scrub, or within 50 metres for Class G: Grassland.

A BAL assessment (basic) cannot be used for strategic planning proposals or subdivision applications.

Evidence such as the most up-to-date aerial photography from Nearmap or Google Earth and photography from the ground demonstrating the absence of vegetation should be submitted with the BAL assessment (basic). Landowners and proponents should be mindful of the native vegetation clearing laws and regulations if there is any vegetation onsite that they wish to remove prior to undertaking the assessment.

The BAL assessment (basic) can be prepared by the landowner/proponent, although it is at the discretion of the decision-maker whether they deem the assessment accurate and fit for purpose.

Where a local government is satisfied that the subject site has been legally cleared since the latest release of the *Map of Bush Fire Prone Areas*, the local government should contact the Office of Bushfire Risk Management to request that the area be removed from the Map in the next revised version, as per the annual review procedures outlined in the *Mapping Standard for Bush Fire Prone Areas*.

7.4 BUILDING PERMIT PROCESS AND BUSHFIRE CONSTRUCTION REQUIREMENTS

A building permit is generally required before construction of a building can commence. As part of the building permit process, a registered building surveyor will need to access the building for compliance with the BCA.

Residential development is generally classified under the BCA as being a Class 1, 2 or 3 building. A building with any of these classifications need to demonstrate compliance with the BCA bushfire construction requirements if located in a designated bushfire prone area. The registered



building surveyor will likely require a BAL Compliance Certificate or a BAL report to assist in determining the level of bushfire resistant construction needed for the building.

For information on Class 9 Buildings refer to Section 8 – Development: Commercial, industrial and community uses.

For more information on building permit process, visit the Department of Mines, Industry, Regulation and Safety's [website](#).

7.5 CLASS 10A BUILDINGS OR DECKS

Class 10a buildings are defined under the Building Code of Australia (BCA) as non-habitable buildings and include a private garage, carport, shed or the like. A Class 10a building or deck associated with a Class 1, 2 or 3 building located in a designated bushfire prone area is required to comply with the BCA bushfire construction requirements. Additional bushfire resistant construction may not be necessary if the Class 10a building or deck is located not less than 6 metres from other buildings on the site.

There is no requirement for a Class 10a building or deck located not less than 6 metres from the habitable building to be assessed or comply with SPP 3.7 or these Guidelines.

RELEVANT SUPPORTING INFORMATION

- > **Appendix A – Bushfire Protection Criteria explanatory notes**
 - A.2 Siting and design**
 - A.3 Vehicular Access**
 - A.4 Water supply**
- > **Appendix B – Bushfire Assessment Methodologies**
 - B.3 BAL Contour Map**
 - B.4 BAL Assessment**
 - B.5 BAL Assessment (BASIC)**
- > **Appendix C – A guide to developing a bushfire management plan**
- > **Fact Sheet – Bushfire and Vegetation**



BPC 7: Bushfire protection criteria for residential development and applications for infill subdivision or strata subdivision of up to and including three residential lots

ELEMENT 1: LOCATION – RESIDENTIAL DEVELOPMENT AND APPLICATIONS FOR INFILL SUBDIVISION OR STRATA SUBDIVISION OF UP TO AND INCLUDING THREE RESIDENTIAL LOTS	
SPP 3.7 OUTCOMES	ACCEPTABLE SOLUTIONS
Not applicable	<p>Area 1: Not applicable.</p> <p>Area 2: Not applicable.</p>
ELEMENT 2: SITING AND DESIGN – RESIDENTIAL DEVELOPMENT AND APPLICATIONS FOR INFILL SUBDIVISION OR STRATA SUBDIVISION OF UP TO AND INCLUDING THREE RESIDENTIAL LOTS	
SPP 3.7 OUTCOMES	ACCEPTABLE SOLUTIONS
O2 Ensure siting and design solutions minimise environmental degradation and manage the bushfire risk to people, property and infrastructure	<p>A2.1a Siting and design Every residential habitable building or development site achieves a potential radiant heat impact of 29 kW/m² (BAL-29) or below.</p> <p>A2.1b Siting within 40 kW/m² (BAL-40) and/or more than 40 kW/m² (BAL-FZ) The siting of a residential habitable building, or a development site(s) within 40 kW/m² (BAL-40) and/or more than 40 kW/m² (BAL-FZ) should only be considered where:</p> <ul style="list-style-type: none"> • the lot was created prior to December 2015; and • there are demonstrated site and/or environmental constraints that prevent the achievement of 29 kW/m² (BAL-29), and • it is demonstrated that the reduction of the building footprint or development site is not practical or appropriate; and • the criteria contained within policy measure 7.2.2 ii of SPP 3.7 are satisfied. <p>If the provision of an APZ in accordance with acceptable solution A2.2 cannot be achieved, then the vegetation immediately surrounding the building is to be managed as defensible space in accordance with Appendix A.2, Table 3 – APZ technical requirements.</p>



A2.2 Asset Protection Zone (APZ)

Where a residential habitable building or development site cannot be wholly within an area of 29 kW/m² (BAL-29) or below in its pre-development state, an APZ is to be provided and meet the following requirements:

- **Width:** the APZ is to be measured from the development site, and of sufficient size to ensure the potential radiant heat impact of a bushfire does not exceed 29 kW/m² (BAL-29) in all circumstances.
- **Location:** the APZ is to be contained solely within the boundaries of the lot, except in instances where:
 - the vegetation on the adjoining lot(s) is managed in a low threat state as per Clause 2.2.3.2 of AS 3959 or the requirements of Appendix A.2, Table 3 - APZ technical requirements, or an alternative standard in a gazetted local planning scheme, on an ongoing basis in perpetuity; or
 - the adjoining land is already in a minimal fuel condition, in perpetuity, such as a sealed or unsealed road, or a water body.
- **Management:** the APZ is managed in accordance with the requirements of Appendix A.2, Table 3 – APZ technical requirements, or in accordance with the local government APZ standards set out in a section 33 notice under the *Bush Fires Act 1954* (local firebreak notice), or an alternative standard in a gazetted local planning scheme.

ELEMENT 3: VEHICULAR ACCESS – RESIDENTIAL DEVELOPMENT AND APPLICATIONS FOR INFILL SUBDIVISION OR STRATA SUBDIVISION OF UP TO AND INCLUDING THREE RESIDENTIAL LOTS

SPP 3.7 OUTCOMES

ACCEPTABLE SOLUTIONS

O3 Ensure the design and capacity of vehicular access and egress provide for efficient and effective evacuation

A3.1 Private driveways

There are no private driveway technical requirements (prescribed by these Guidelines) where the private driveway is within a lot serviced by reticulated water and is no greater than 70 m in length between the most distant external part of the habitable building and the public road.

In circumstances where the above conditions are not met, the private driveway is to meet all of the following requirements:

- requirements in Appendix A.3 Table 4, column 5; and
- passing bays every 200 m with a minimum length of 20 m and a minimum additional trafficable width of 2 m (i.e. the combined trafficable width of the passing bay and constructed private driveway to be a minimum 6 m); and
- turn-around area (Figure 14) and within 30 m of the residential habitable building (Figure 22).

A3.2 Battle-axe access legs for subdivision applications (up to three lots) within Area 1

There are no battle-axe technical requirements (prescribed by these Guidelines) where the point of the battle-axe access leg joins the effective area of the battle-axe lot/s, is less than 50 m from a public road in a reticulated water area.

In circumstances where the above condition is not met, or the battle-axe lot is in a non-reticulated water area, the battle-axe access leg is to meet all the following requirements:

- requirements in Appendix A.3, Table 4, Column 5; and
- turn-around area (Figure 14) and within 30 m of a residential habitable building (Figure 22).



ELEMENT 4: WATER SUPPLY – RESIDENTIAL DEVELOPMENT AND APPLICATIONS FOR INFILL SUBDIVISION OR STRATA SUBDIVISION OF UP TO AND INCLUDING THREE RESIDENTIAL LOTS

SPP 3.7 OUTCOMES

ACCEPTABLE SOLUTIONS

O4 Ensure that sufficient water is available to enable people, property and infrastructure to be defended from bushfire

A4.1 Water supply for residential habitable buildings

Where a reticulated water supply is existing or proposed, a hydrant connection(s) should be provided in accordance with the specifications of the relevant water supply authority.

Where these specifications cannot be met, a water tank(s) should be provided in accordance with the requirements of Appendix A.4, Table 5 – Water supply dedicated for bushfire firefighting.

A4.2 Water supply for subdivision applications (up to three lots), including any existing habitable building, within Area 1

Hydrant connection(s) should be provided in accordance with the specifications of the relevant water supply authority.



8 DEVELOPMENT – COMMERCIAL, INDUSTRIAL AND COMMUNITY USES

The following application types should address the requirements within this Section:

- An application for the development of, or additions to, a habitable building for commercial, industrial or community uses within Area 1 or Area 2
- An application for the development of, or additions to, a habitable building for a vulnerable commercial, industrial or community purpose, within Area 1 or Area 2, that are not tourism land uses.

Commercial or community vulnerable land uses include, but are not limited to:

- **uses designed to accommodate people who are less physically or mentally able and are likely to present evacuation challenges. Examples may include the elderly, children (under 18 years of age), and the sick or injured, in dedicated facilities such as aged or assisted care, nursing homes, education centres, education establishments, schools, childcare centres, hospitals and rehabilitation centres**
- **facilities that, due to the building design or use, or the number of people accommodated, are likely to present evacuation challenges. Examples includes corrective institutions (prisons), large community purpose centres or large places of worship.**

The identification of an application as vulnerable is at the discretion of the decision-maker. Where the decision-maker determines that, based on the number of potential occupants, the development type and/or the location, that a bushfire emergency plan would assist in the emergency management arrangements of the site and the occupants in a bushfire event, then the application will be treated as vulnerable, and the provisions of this Section will be applied to its assessment.

This Section also includes the bushfire requirements under the BCA for certain types of Class 9 buildings.

8.1 DESIGN CONSIDERATIONS

The siting, layout and design should respond to the bushfire risk presented by the interface with classified vegetation adjoining the subject site and any remaining or proposed classified vegetation within the subject site. Asset Protection Zones (APZs) are commonly used to mitigate the bushfire threat within a lot. Strategic management of vegetation and plant flammability within the APZ should be considered in accordance with Appendix A.2. Where possible, development should be in existing cleared area(s) to reduce the need for modification or removal of vegetation.

Topography has a direct correlation to rate of spread of a bushfire and should be considered when identifying development sites or when introducing vegetation or regenerating existing vegetation. Ridge tops, crests, narrow gullies and steep slopes (Figure 6) often provide amenity and scenic views over a landscape, but are particularly dangerous in a bushfire, as fire can accelerate in these areas.

Although topography and existing cleared areas often compete with other planning considerations, where there is opportunity, the development site should be selected to reduce the bushfire threat.

Where possible, private driveways should provide a line of sight to the public road, to aid access by emergency services. Consideration should be given to internal access for emergency services vehicles, to both the building and any hazard (vegetation). If the use is vulnerable, then access should be provided to facilitate the evacuation of occupants and to allow for emergency services to attend the site.

Incidental 'open-air' land-uses associated with a habitable building are not required to be in an area subject to a radiant heat impact of 29 kw/m² or less. These uses include, but are not limited to, carparking areas, playgrounds, tennis courts, car yards, golf courses, parks and excavation sites.

8.1.1 Storage of hazardous materials

Some commercial or industrial development may involve the storage of flammable, combustible and/or hazardous materials, including chemical or toxic processes, that are not at a quantity that trigger the requirement for a licence under the *Dangerous Goods Safety Act 2004* or the *Environmental Protection Act 1986*, but could still potentially pose a risk to the community or emergency services due to the increased potential to ignite, intensify and prolong a bushfire. Flammable, combustible and hazardous materials may include flammable liquids, flammable solids, gases, corrosives and oxidizing substances.



Where a proposed development involves the storage of flammable, combustible or hazardous materials, which do not trigger a licence under the *Dangerous Goods Safety Act 2004* or the *Environmental Protection Act 1986*, the bushfire management plan should identify all of the following:

- the type and quantity of the flammable hazards proposed to be stored on-site, in context of the bushfire risk and scale of the development
- demonstrate that the hazardous materials are shielded from radiant heat from the bushfire hazard
- implementation measures are contained within the bushfire management plan for the on-site storage and/or management of any on-site storage of hazardous materials.

8.1.2 Siting in BAL-40 or BAL-FZ

Habitable buildings within 40 kW/m² (BAL-40) or BAL-FZ are likely to have direct exposure to flame contact, as well as radiant heat impact in excess of 40 kW/m² and be subject to ember attack. Bushfire research has found that the separation distance between a structure and classified vegetation is a good indicator of the likelihood of damage by fire, with a clear trend towards greater total loss as the separation distance between vegetation and building decreases. This research identified that even where houses have been constructed to flame zone construction standards, house loss is still occurring.

There are occasions where a lot(s) has been created prior to implementation of SPP 3.7 and the Guidelines in December 2015 and due to site and/or environmental constraints, a habitable building is unable to be located within 29 kW/m² (BAL-29) or below. SPP 3.7 and the Guidelines recognise the expectation to be able to build

a habitable building on a lot that is zoned for this purpose and as such provides a pathway for the consideration of siting within areas subject to 40 kW/m² (BAL-40) or BAL-FZ in exceptional circumstances.

The 2019 edition of the Building Code of Australia does not include bushfire construction requirements for most commercial, industrial and community purpose buildings. However, where buildings are proposed within areas subject to 40 kW/m² (BAL-40) or BAL-FZ, the bushfire resilience of the building should be maximised through the use of design solutions commensurate with those detailed within the BCA and AS 3959, where appropriate.

The siting of vulnerable land uses within 40 kW/m² (BAL-40) or BAL-FZ present additional challenges. Consideration will need to be given to the ability of the occupants to be able to evacuate in the event of a bushfire. Where it is expected that large numbers of people will be on-site at any one time and/or where the occupants are vulnerable, evacuation may not be a suitable option. In these instances, development should not be supported in areas subject to 40 kW/m² (BAL-40) or BAL-FZ.

8.1.3 Extensions or modifications to an existing habitable building

Where a development application for the construction and/or use of a habitable building for commercial, industrial or community uses, was approved prior to SPP 3.7 (2015) and the Guidelines, any subsequent development application for the modification or extension to the development, will require assessment and the preparation of a bushfire management plan where the extensions or modification will result in an intensification of development or will result in an increase in the bushfire risk.

The bushfire protection criteria should be demonstrated for the entire site, however it should be noted that there are no requirements under SPP 3.7 or the Guidelines to retrofit existing buildings to the appropriate bushfire construction standard, or any requirement for these existing buildings to be located within 29 kW/m² (BAL-29) or below.

Where the use is a vulnerable land use, the preparation of an bushfire emergency plan for the entire site is required.

8.1.4 Certain Class 9 Buildings and the Building Code of Australia

The 2019 edition of the BCA does not currently require Class 4, 5, 6, 7, 8 or 9 buildings to comply with bushfire construction requirements if located in a designated bushfire prone area.

However, the 2022 edition of the BCA will introduce bushfire construction requirements for certain types of Class 9 buildings located in a designated bushfire prone area, including:

- Class 9a health-care buildings
- Class 9b early childhood centres and primary or secondary schools
- Class 9c residential care buildings
- A Class 10a building or deck immediately adjacent or connected to one of the buildings listed above.

It is expected that these buildings will need to address bushfire construction requirements when the 2022 edition of the BCA takes effect in Western Australia. Further information, including amendments to these Guidelines, will be provided when that occurs.



Many Class 9 buildings are vulnerable land uses and require the preparation of a bushfire emergency plan.

8.2 INFORMATION TO ACCOMPANY THE DEVELOPMENT APPLICATION

A BAL assessment, or BAL Contour Map, should be prepared for the proposed development and accompany the application. Applications that propose multiple habitable buildings should submit a BAL Contour Map, instead of a BAL assessment, to better demonstrate that each habitable building can achieve 29 kW/m² (BAL-29) or below.

Where a BAL Contour Map was prepared as part of the subdivision and/or structure plan, a compliance certificate should be provided to confirm that, following completion of subdivision works, the indicative BAL remains accurate. This can then be used for the purpose of the development application.

If the BAL assessment or BAL Contour Map indicates that the proposed development will have a BAL rating above BAL-LOW, a bushfire management plan should accompany the application and include the following information at a scale that is appropriate for the development:

- a. the identification of any environmental, biodiversity or conservation values on the subject site that may be impacted by any proposed clearing or modification of vegetation, necessary to mitigate bushfire risk
- b. a BAL Contour Map or BAL assessment
- c. an assessment of the broader landscape (for vulnerable land uses located within an area designated as Area 2)
- d. the identification of any bushfire hazard issues arising from the assessment

- e. assessment against the bushfire protection criteria, demonstrating compliance via either the acceptable solutions, or through an outcomes-based approach.

8.2.1 Additional information:

Where a proposed habitable building(s) or development site(s) is within 40 kW/m² (BAL-40) or above (BAL-FZ), the bushfire management plan should include additional information in accordance with policy measure 7.2.2 of SPP 3.7.

A bushfire emergency plan should be prepared when an application for a vulnerable land use is proposed.

8.2.2 BAL assessment (basic)

A BAL assessment (basic) is prepared for a development application where the development site is within a designated bushfire prone area, but there is no apparent bushfire risk to the development site from vegetation classified under AS 3959.

RELEVANT SUPPORTING INFORMATION

- > **Appendix A – Bushfire Protection Criteria explanatory notes**
 - A.1 Location
 - A.2 Siting and design
 - A.3 Vehicular Access
 - A.4 Water supply
- > **Appendix B – Bushfire Assessment Methodologies**
 - B.1 Broader landscape assessment
 - B.3 BAL Contour Map
 - B.4 BAL Assessment
 - B.5 BAL Assessment (BASIC)
- > **Appendix C – A guide to developing a bushfire management plan**
- > **Appendix D – A guide to developing a bushfire emergency plan**
- > **Fact Sheet – Bushfire and Vegetation.**



BPC 8: Bushfire protection criteria for commercial, industrial and community uses

ELEMENT 1: LOCATION – VULNERABLE COMMERCIAL, INDUSTRIAL AND COMMUNITY USES

SPP 3.7 OUTCOMES

ACCEPTABLE SOLUTIONS

O1 Avoid broader landscapes that present an unacceptable risk to life, property and infrastructure

Area 1: Not applicable.

Area 2: Applies to vulnerable land uses only.

Determine the Broader Landscape Type in accordance with Appendix B.1. Then proceed under A1.1, A1.2 or A1.3.

A1.1 Broader Landscape Type A

The vulnerable development application is located in an area that is a Broader Landscape Type A – no additional landscape consideration is required.

A1.2 Broader Landscape Type B

Where a vulnerable development application is located in an area that is a Broader Landscape Type B, it should be demonstrated that:

- The risks presented by the broader landscape can be mitigated to an acceptable level, using the bushfire protection criteria contained in Elements 2 – 4 or any additional mitigation measures; and
- The development application maintains or improves the evacuation capacity of the road network in the event of a bushfire evacuation and does not make the current situation worse; and
- Evacuation to a suitable destination in the event of a bushfire can be achieved.

A1.3 Broader Landscape Type C

Vulnerable development applications located in an area that is a Broader Landscape Type C present an unacceptable bushfire risk and the intensification of land use or development should be avoided. For applications to be further considered an outcomes-based approach, in accordance with policy measure 7.4 of SPP 3.7 can be undertaken.

ELEMENT 2: SITING AND DESIGN – ALL COMMERCIAL, INDUSTRIAL AND COMMUNITY USES

SPP 3.7 OUTCOMES

ACCEPTABLE SOLUTIONS

O2 Ensure siting and design solutions minimise environmental degradation and manage the bushfire risk to people, property and infrastructure

A2.1 Siting and design

Every habitable building achieves a potential radiant heat impact of 29 kW/m² (BAL-29) or below.



A2.1b Siting within 40 kW/m² (BAL-40) and/or more than 40 kW/m² (BAL-FZ)

The siting of a commercial or industrial habitable building, except for vulnerable land uses, within 40 kW/m² (BAL-40) and/or more than 40kW/m² (BAL-FZ) should only be considered where:

- the lot was created prior to December 2015; and
- there are demonstrated site and/or environmental constraints that prevent the achievement of 29 kW/m² (BAL-29), and
- it is demonstrated that the reduction of the building footprint or development site is not practical or appropriate; and
- the criteria contained within policy measure 7.2.2 ii of SPP 3.7 are satisfied.

If the provision of an APZ in accordance with acceptable solution A2.2 cannot be achieved, then the vegetation immediately surrounding the building is to be managed as defendable space in accordance with Appendix A.2, Table 3 – APZ technical requirements.

A2.2 Asset Protection Zone (APZ)

Where a habitable building cannot be wholly within an area of 29 kW/m² (BAL-29) or below in its pre-development state, an APZ is to be provided and meet the following requirements:

- **Width:** the APZ is to be measured from any external wall or supporting post or column of the building, and of sufficient size to ensure the potential radiant heat impact of a bushfire does not exceed 29 kW/m² (BAL-29) to any part of the building, in all circumstances.
- **Location:** the APZ is to be contained solely within the boundaries of the lot on which the building is situated, except in instances where:
 - the vegetation on the adjoining lot(s) is managed in a low threat state as per AS 3959 or the requirements of Appendix A.2, Table 3 – APZ technical requirements, or in accordance with any APZ standards set out in a section 33 notice under the *Bush Fires Act 1954* (local firebreak notice), or an alternative standard in a gazetted local planning scheme, on an ongoing basis in perpetuity; or
 - the adjoining land is already in a minimal fuel condition, in perpetuity, such as a managed sealed or unsealed road or a water body.
- **Management:** the APZ is managed in accordance with the requirements of Appendix A.2, Table 3 – APZ technical requirements, or in accordance with the local government APZ standards set out in a section 33 notice under the *Bush Fires Act 1954* (local firebreak notice), or an alternative standard in a gazetted local planning scheme

A2.3 Storage of hazardous materials

Where a proposed land use will include the storage of hazardous materials, which would increase the intensity of a bushfire, as part of its ongoing day to day operations, the hazardous materials are to be stored in an area that:

- achieves a radiant heat impact of 29 kW/m² (BAL-29) or below; and
- shields the material from the radiant heat from the bushfire hazard.



ELEMENT 3: VEHICULAR ACCESS – COMMERCIAL, INDUSTRIAL AND COMMUNITY USES

SPP 3.7 OUTCOMES

ACCEPTABLE SOLUTIONS

O3 Ensure the design and capacity of vehicular access and egress provide for efficient and effective evacuation

A3.1 Public roads

A public road is to meet the requirements in Appendix A.3, Table 4, Column 2.

A3.2 Access routes

Area 1: Public road access is to be provided to at least one suitable destination.

Area 2: Public road access should be provided in two different directions to at least two different suitable destinations, with an all-weather surface.

A3.3 No-through roads

Area 1: No limitation on no-through road lengths.

Area 2: No-through roads should be avoided. If the public road access to the subject site is via a no-through road which cannot be avoided due to demonstrated site constraints, the public road access is to be a maximum of 200 m from the subject site to an intersection where two-way access is provided.

The no-through road may exceed 200 m if it is demonstrated that an alternative access, including an emergency access way, cannot be provided due to site constraints and the following requirements are met:

- the no-through road travels towards a suitable destination; and
- the balance of the no-through road, that is greater than 200 m from the subject site, is wholly within BAL-LOW, or is within a residential built-out area, or is within Area 1 (Figure 13).

A no-through road is to meet all the following requirements:

- requirements of a public road (Appendix A.3, Table 4, Column 2); and
- turn-around area/head (Figure 14).

A3.4 Emergency access way

Where it is demonstrated that A3.2 and A3.3 cannot be achieved due to site constraints, an emergency access way can be considered as an acceptable solution.

An emergency access way is to meet all the following requirements:

- requirements in Appendix A.3, Table 4, Column 3;
- provides a through connection to a public road;
- be no more than 500 m in length; and
- must be signposted and if gated, gates must open for the whole trafficable width remain unlocked.



A3.5 Private driveways

There are no private driveway technical requirements (prescribed by these Guidelines) where the private driveway is within a lot serviced by reticulated water and is no greater than 70 m in length between the most distant external part of the habitable building and the public road.

In circumstances where the above conditions are not met, the private driveway is to meet all of the following requirements:

- requirements in Appendix A.3 Table 4, Column 5; and
- passing bays every 200 m with a minimum length of 20 m and a minimum additional trafficable width of 2 m (i.e. the combined trafficable width of the passing bay and constructed private driveway to be a minimum 6 m); and
- turn-around area (Figure 14) and within 30 m of the habitable building (Figure 22).

ELEMENT 4: WATER SUPPLY – COMMERCIAL, INDUSTRIAL AND COMMUNITY USES

SPP 3.7 OUTCOMES

ACCEPTABLE SOLUTIONS

O4 Ensure that sufficient water is available to enable people, property and infrastructure to be defended from bushfire

A4.1 Water supply

Where a reticulated water supply is existing or proposed, a hydrant connection(s) should be provided in accordance with the specifications of the relevant water supply authority.

Where these specifications cannot be met, a water tank(s) should be provided in accordance with the requirements of Appendix A.4, Table 5 – Water supply dedicated for bushfire firefighting.



9 VULNERABLE TOURISM LAND USES

Tourism land uses are considered vulnerable land uses when they involve visitors who are unfamiliar with the surroundings and/or where they present evacuation challenges.

SPP 3.7 and the Guidelines cannot account for all situations, including the specific tourism needs, the known bushfire risks, or emergency services capacity, within a local area. Local governments are encouraged to:

- identify within their local planning strategy appropriate locations for tourism land uses, or alternatively identify those areas of extreme bushfire risk and/or areas with limited vehicular access, where tourism land uses should be avoided
- amend or require the proponent to initiate an amendment to their local planning scheme to zone land Tourism, for those proposals considered regionally or locally significant by the State or local government. This will facilitate strategic State level consideration of the bushfire risk, by the WAPC
- consult with local emergency services when considering tourism land uses.

9.1 DESIGN CONSIDERATIONS

9.1.1 General

Developing tourism land uses within remote and/or heavily vegetated areas comes with an inherent risk of bushfire, which can be reduced but never fully eliminated. Such risks must be understood in order to anticipate and manage them and foster a culture of resilience at all levels.

Each tourism land use will present different evacuation challenges and different risk profiles, dependant on locational characteristics, number of patrons and management arrangements, including the presence of a resident/manager on site. It is important to consider these differences and provide suitable bushfire risk management measures that respond to the unique nature of the tourism land use and location. The acceptable solutions provided should be treated as a minimum requirement and if deemed necessary by the bushfire planning practitioner, or decision-maker, additional bushfire risk management measures should be included.

Construction standards

It is acknowledged that for some tourism structures, such as tents, caravans and cabins, construction complying with AS 3959 may be impossible to achieve and consideration should be given to whether, in the event of a bushfire, the loss of these structures is a tolerable loss. If not, then an Asset Protection Zone should be provided to minimise the likelihood of loss of these structures during a bushfire event.

The bushfire planning practitioner should also consider construction of tourism structures above the requirements contained within the bushfire protection criteria of this Section and to the extent possible, construction in accordance with AS 3959, to improve resilience to bushfire.

This should be clearly detailed within the bushfire management plan.

Vehicular access and traffic management

Vehicular access and traffic management, including the ability for vehicles to quickly evacuate the site in the event of a bushfire, will be an important consideration.

Directional signage and advice on what to do and where to go in the event of a bushfire, should be clearly provided.

Some tourism land uses, particularly when remote, face challenges with satisfying the requirement for two access ways in two different directions, to two suitable destinations.

If an outcomes-based approach is being developed to justify a no-through road exceeding 200 metres, consideration could be given to the information contained within Appendix A.3 – Vehicular access and to the following additional suggested measures:

- a bushfire emergency plan provides for closure during days forecasted to be an extreme or catastrophic fire danger rating, a total fire ban and/or a fire behaviour index of 75 or above; and for the early evacuation of guests and staff; or
- where a bushfire emergency plan provides for non-operation during the bushfire season.

It is noted that these additional measures are not suitable for most tourism land uses but could be applied in some limited circumstances.

The private driveway or internal vehicular access from the public road network to the development site(s) should be designed to provide for unobstructed access and egress. Internal vehicular access should include passing bays, be six metres wide and should allow for multiple vehicular access points onto the public road network, where possible.

9.1.2 Remote camping grounds

Remote camping grounds may be low-cost and/or small-scale with the aim of having minimal or no impact on the environment. They may be isolated from town sites and



emergency services. They are often located on Crown reserves, unallocated Crown land or pastoral stations, although some may be located on private property. They may provide limited facilities, such as a manager's house, toilets, washing up facilities or camper's kitchen, but often there will be no facilities, with campers expected to be fully self-contained.

Bushfire is an inherent risk in many of these areas, and it is the responsibility of the owner/operator to inform visitors of the risk and the options available in the event of a bushfire. It is also the responsibility of those visiting these areas to understand and prepare for the risk. Vehicular access may be limited to a four-wheel drive. Drinking water and water for firefighting may not be available.

The bushfire management plan and the bushfire emergency plan should identify risks and propose bushfire risk management measures to reduce risk. This could include improvements to vehicular access, signage and options for on-site and off-site shelter (evacuation).

9.1.3 Holiday house

The regulatory framework for a holiday house is currently being considered by the Western Australian Planning Commission's draft Tourism Position Statement.

The Planning For Bushfire Guidelines will reflect the final Tourism Position Statement.

9.1.4 Tourism day uses

Tourism day uses involve no overnight stay and may include, art galleries, breweries, exhibition centres, reception centres, restaurants/cafés, small bars, taverns, and wineries. Not all tourism day uses are vulnerable land uses.

Vulnerability should be determined on a case-by-case basis by the decision-maker, with consideration being given to criteria including, but not limited to:

- a) options for vehicular egress and access in the event of a bushfire, to a suitable destination**
- b) the maximum number of visitors and staff on-site at any one time**
- c) whether the visitors are likely to be tourists who are unfamiliar with the area, or visitors from the local area**
- d) whether the visitors have special needs, such as the elderly, disabled or children.**

Many day uses can rely on closure in response to a pre-determined fire danger rating and/or on the issue of a total fire ban on any given day. Most of these uses would have a manager and/or staff member on site, who is able to activate the emergency procedures. In most cases, visitors to the site would have travelled in their own or shared vehicle or tourist bus and would be able to evacuate the premises in the manner they came. Details on emergency bushfire procedures for occupants of the facility, should be detailed in a bushfire emergency plan.

9.1.5 Outdoor events

Outdoor events often cater for large numbers of people in isolated locations and can continue over a number of days. They include music festivals and sporting events. Events that involve overnight camping, multiple days, or attract large numbers of people in bushfire prone areas require careful consideration.

Local governments may consider some of these uses as temporary works, exempt from development approval under section 61(1)(f) of the LPS Regulations 2015. Where an outdoor event is considered exempt, but the surrounding bushfire threat and/or the number of persons anticipated to attend the event, creates an evacuation risk, the decision-maker should consider, at the least, requiring the preparation of a bushfire emergency plan.

Where a development application is required, partial application of SPP 3.7 and the Guidelines is required, noting that there are no requirements for uses, other than habitable buildings, to be located within an area subject to 29 kW/m² (BAL-29). In addition to the bushfire protection criteria, the following should be considered:

- holding events outside the gazetted bushfire danger period for the area and consideration of cancelling events on a pre-determined fire danger rating and/or the issue of a total fire ban
- vehicular access and egress routes for emergency services and patrons in the event that evacuation is required
- a suitable method of staging evacuation, ensuring that evacuation flow is directed through different areas or exit points of the site
- expected evacuation timeframes



- ability to cease and override the public address (PA) and audio systems throughout the site to announce emergency warnings, alerts or safety information, which can be clearly heard from all areas of the site
- a prescribed ratio of trained fire wardens to participants
- bulk water supplies and associated firefighting infrastructure on site that are specifically allocated to firefighting purposes
- slashing of grassed areas in the lead-up to the event and maintained throughout its duration
- emergency management planning during the event organisation stage to be undertaken in consultation with the relevant local government and emergency services in the area
- fires for cooking and heating in approved fireplaces only.

On-site shelter for large numbers of patrons and staff, should be considered with caution.

9.2 CONTINGENCY MEASURES TO MITIGATE RISK

9.2.1 Closure of a tourism land use

Consideration should be given to the closure of a tourism land use in response to a pre-determined fire danger rating and/or the issue of a total fire ban on any given day. It is acknowledged that closure may not be realistic for overnight facilities, however, could apply where there are incidental day uses. This option would be reliant on a caretaker or staff member available on-site and able to activate the approved bushfire emergency plan.

Closure requires adoption of a trigger point. The Department of Fire and Emergency Services generally recommends leaving an area when the fire danger rating is 'extreme' or 'catastrophic', or alternatively when the fire behaviour index is 75 or above.

Closure could also relate to closure of a facility during the bushfire season.

The closure of a tourism development should be identified within the bushfire emergency plan and enforced through a condition of the development approval.

In some situations, such as remote vulnerable tourism land uses, it may be safer to require all staff and guests to remain on-site for the day as opposed to undertaking day visits, where communication may be more difficult.

9.2.2 Off-site shelter (evacuation)

Early evacuation in response to Department of Fire and Emergency Services alerts during a bushfire event should be reinforced through a bushfire emergency plan.

The bushfire emergency plan should identify an off-site location(s) for evacuation that will provide somewhere to evacuate to, that considers factors such as location, transportation arrangements to the location, its size and capacity. Consultation should occur with the local government and local emergency management committee when identifying an off-site location for evacuation.

9.2.3 On-site shelter

It should be emphasised that on-site shelter is not a standalone contingency to managing risk to life and safety. In most instances early evacuation of visitors and

staff based on an imminent bushfire threat should be the first consideration and will form the basis of a successful bushfire emergency plan.

Where on-site shelter is contemplated, the shelter should be provided with sufficient space for the maximum number of employees and visitors that could be on-site at any given time and should be within easy walking distance from the tourism land use, with a designated and sign-posted footpath. The *ABCB Design and Construction of Community Bushfire Refuges Handbook (2014)* recommends 0.75 m² per person, however it is recommended that a minimum of 1.0 m² per person be considered.

9.2.4 On-site shelter in a nominated building

The building nominated to be used as an on-site shelter, should be designed to withstand bushfire attack in the form of wind, smoke, embers, radiant heat and flame contact.

A building proposed for this purpose needs to have a sufficient separation distance from the predominant bushfire prone vegetation, including a safety factor that correlates to the level of risk for the site and the vulnerability of the inhabitants. The highest level of protection will be achieved when the on-site shelter is designed and constructed by a suitably qualified fire engineer in accordance with the BCA and the ABCB Design and Construction of Community Bushfire Refuges Handbook (2014).

The ongoing maintenance of the building and the surrounding separation distances from the bushfire prone vegetation will be the responsibility of the owner/operator. A 'maintenance plan' should detail the maintenance and annual testing requirements.



9.2.5 On-site shelter in a nominated open space area

Where a tourism land use provides no facilities or built structures that could be utilised for on-site shelter, such as a camping ground, an open space area may be acceptable for on-site shelter, as a last resort.

Where an open space area is being proposed, the site and surrounding site vegetation modification and management should seek to achieve a radiant heat flux of 2 kW/m² or less (with an assumed flame temperature of 1200 K). Whilst a radiant heat flux of 2 kW/m² or less is an acceptable level of heat exposure, it does not address the respiratory impacts from smoke or the potential for ember attack. Any ability to provide some shelter, such as a roofed area or shielding, would be beneficial.

Some remote coastal camping sites, where it can be demonstrated that the potential for ember attack from the coastal vegetation, is not significant, may be able to utilise the beach as an open space area to shelter.

The ongoing maintenance of the separation distances from the bushfire prone vegetation will be the responsibility of the owner/operator.

It should be noted that this is an option of last resort and closure of the venue ahead of a bushfire event, and/or evacuation off-site where safe to do so, is recommended.

9.3 INFORMATION TO ACCOMPANY THE DEVELOPMENT APPLICATION

A BAL assessment, or BAL Contour Map, should be prepared for the proposed development and accompany the development application. Applications that propose multiple habitable buildings should submit a BAL Contour

Map, instead of a BAL assessment, to better demonstrate that each habitable building can achieve 29 kW/m² (BAL-29) or below.

If the BAL assessment or BAL Contour Map indicates that the proposed development will have a BAL rating above BAL-LOW, a bushfire management plan should accompany the application and include the following information at a scale that is appropriate for the development:

- a. The identification of any environmental, biodiversity or conservation values on the subject site that may be impacted by any proposed clearing or modification of vegetation, necessary to mitigate bushfire risk
- b. a BAL Contour Map or BAL assessment
- c. an assessment of the broader landscape (where required)
- d. the identification of any bushfire hazard issues arising from the assessment
- e. assessment against the bushfire protection criteria, demonstrating compliance with either the acceptable solutions, or through an outcomes-based approach.

9.4 BUSHFIRE EMERGENCY PLAN

It is a requirement under SPP 3.7 for all vulnerable land uses to be accompanied by a bushfire emergency plan, which details implementation mechanisms to support the bushfire management plan.

9.5 CONDITIONS OF DEVELOPMENT APPROVAL WHERE ON-SITE SHELTER IS PROPOSED

While closure and early evacuation are recommended in the first instance, it is recommended that the following conditions are imposed on a development approval where on-site shelter in a building is proposed. Note that where an on-site open space shelter is proposed only conditions d and c would be required.

- a) The on-site shelter must be designed and constructed in accordance with the Building Code of Australia and the ABCB Design and Construction of Community Bushfire Refuges Handbook (2014). The design must be undertaken by a suitably qualified fire engineer with fire risk assessment expertise, accredited with Engineers Australia.
- b) Prior to occupation of the development, a final inspection of the on-site shelter must be undertaken by a suitably qualified fire engineer with fire risk assessment expertise, accredited with Engineers Australia. The fire engineer shall provide certification, to the satisfaction of the local government, that the works have been completed in accordance with the requirements of the BCA and the ABCB Design and Construction of Community Bushfire Refuges Handbook (2014).
- c) Prior to occupation of the development, an on-site shelter maintenance plan must be prepared by a suitably qualified fire engineer with fire risk assessment expertise, accredited with Engineers Australia, and must include:
 - i) details of maintenance requirements, and
 - ii) details of annual testing requirements for operational compliance.



- d) Annual testing shall include the lodgement of a compliance certification by a suitably qualified fire engineer, to the local government at least one month prior to the start of the bushfire season.

RELEVANT SUPPORTING INFORMATION

- > **Appendix A – Bushfire Protection Criteria explanatory notes**
 - A.1 Location
 - A.2 Siting and design
 - A.3 Vehicular Access
 - A.4 Water supply
- > **Appendix B – Bushfire Assessment Methodologies**
 - B.1 Broader landscape assessment
 - B.3 BAL Contour Map
 - B.4 BAL Assessment
- > **Appendix C – A guide to developing a bushfire management plan**
- > **Appendix D – A guide to developing a bushfire emergency plan**



BPC 9: Bushfire protection criteria for vulnerable tourism land uses

ELEMENT 1: LOCATION FOR VULNERABLE TOURISM LAND USES

SPP 3.7 OUTCOMES

ACCEPTABLE SOLUTIONS

O1 Avoid broader landscapes that present an unacceptable risk to life, property and infrastructure

Area 1: Not applicable.

Area 2: Only where an outcomes-based approach is required for Elements 2, 3 or 4.

Determine the Broader Landscape Type in accordance with Appendix B.1. Then proceed under A1.1, A1.2 or A1.3.

A1.1 Broader Landscape Type A

Where the vulnerable land use is located in an area that is a Broader Landscape Type A – no additional landscape consideration is required.

A1.2 Broader Landscape Type B

Where the vulnerable land-use is located in an area that is a Broader Landscape Type B, it should be demonstrated that:

- The risks presented by the broader landscape can be mitigated to an acceptable level, using the bushfire protection criteria contained in Elements 2 – 4 or any additional mitigation measures; and
- The planning proposal maintains or improves the evacuation capacity of the road network in the event of a bushfire and does not make the current situation worse; and
- Evacuation to a suitable destination in the event of a bushfire can be achieved.

A1.3 Broader Landscape Type C

The vulnerable land use is located in an area that is a Broader Landscape Type C, which presents an unacceptable risk and the intensification of land use or development should be avoided. For applications to be further considered an outcomes-based approach, for Element 1 in accordance with policy measure 7.4 of SPP 3.7 can be undertaken.

ELEMENT 2: SITING AND DESIGN FOR VULNERABLE TOURISM LAND USES

SPP 3.7 OUTCOMES

ACCEPTABLE SOLUTIONS

O2 Ensure siting and design solutions minimise environmental degradation and manage the bushfire risk to people, property and infrastructure

A2.1 Caravan Park APZ

For caravan parks, including camping grounds, the provision of an APZ to achieve 29 kW/m² (BAL-29) or below around the campground facilities, which include the office, manager’s residence, camper’s kitchen, and shower/laundry, in accordance with A2.2 of Section 7 - Development - Residential.

Where the bushfire management plan identifies accommodation structures, including, but not limited to, caravan and camping sites, eco tents and cabins, as a tolerable loss in the event of a bushfire, these accommodation structures can be sited in areas above 29 kW/m² (BAL-29).



A2.2 All other short-term accommodation (except caravan parks) APZ

For all other short-term accommodation, the provision of an APZ to achieve 29 kW/m² (BAL-29) or below around habitable buildings, in accordance with A2.2 of Section 7 - Development - Residential.

A2.3 All short-term accommodation: Landscape management plan

Area 2: A landscape management plan is to be prepared to identify on-going on-site vegetation management.

A2.4 On-site shelter

Where an on-site shelter is proposed, to comply with A3.5 On-site shelter, it is to meet all the following requirements:

- Pedestrian paths to any on-site shelter should be provided and be clearly signposted;
- Where a building is to function as an on-site shelter, there is to be sufficient separation distance from the predominant bushfire prone vegetation to avoid exposure to a radiant heat flux exceeding 10 kW/m² (with an assumed flame temperature of 1200 K); or where an open space area is to function as an on-site shelter, there is to be sufficient separation distance from the bushfire prone vegetation to avoid exposure to a radiant heat flux exceeding 2 kW/m² (with an assumed flame temperature of 1200 K); and
- Buildings identified as suitable for on-site shelter, to be designed in accordance with *Building Code of Australia* and the *ABCB Design and Construction of Community Bushfire Refuges Handbook* and located within an area of 10 kW/m².

ELEMENT 3: VEHICULAR ACCESS FOR VULNERABLE LAND USES

SPP 3.7 OUTCOMES

ACCEPTABLE SOLUTIONS

O3 Ensure the design and capacity of vehicular access and egress provide for efficient and effective evacuation

A3.1 Public roads

A public road is to meet the requirements in Appendix A.3, Table 4, Column 2.

A3.2 Access routes

Area 1: Public road access is to be provided to at least one suitable destination.

Area 2: Public road access should be provided in two different directions to at least two different suitable destinations, with an all-weather surface.

A3.3 No-through roads

Area 1: No limitation on no-through road lengths.

Area 2: No-through roads should be avoided. If the public road access to the subject site is via a no-through road which cannot be avoided due to demonstrated site constraints, the public road access is to be a maximum of 200 m from the subject site to an intersection where two-way access is provided.



The no-through road may exceed 200 m if it is demonstrated that an alternative access, including an emergency access way, cannot be provided due to site constraints and if the following requirements are met:

- the no-through road travels towards a suitable destination; and
- the balance of the no-through road, that is greater than 200 m from the subject site, is wholly within BAL-LOW, or is within a residential built-out area, or is within Area 1 (Figure 13).

A no-through road is to meet all the following requirements:

- requirements of a public road; and
- turn-around area/head (Figure 14).

A3.4 Emergency access ways

Where it is demonstrated that A3.2 and A3.3 cannot be achieved, an emergency access way can be considered as an acceptable solution. An emergency access way is to meet all of the following requirements:

- Requirements in Appendix A.3, Table 4, Column 3;
- Provide a through connection to a public road;
- Be no more than 500 m in length; and
- Must be signposted and if gated, gates must remain unlocked.

A3.5 On-site shelter

Where A3.2, A3.3 and A3.4 (if required), cannot be achieved, and the proposed development has a capacity of up to a maximum of 50 guests and staff at any one time, an on-site shelter is to be provided in accordance with A2.4.

Where A3.2, A3.3 and A3.4 (if required), cannot be achieved and more than 50 guests and staff are proposed, and/or the bushfire planning practitioner considers an on-site shelter not necessary, an outcomes-based approach can be prepared.

A3.6 Internal vehicular access and private driveways

Internal vehicular access and private driveways longer than 70 metres should meet all the following requirements:

- Requirements in Appendix A.3, Table 4, Column 5;
- Passing bays every 200 m with a minimum length of 20 m and a minimum additional trafficable width of 2 m (that is, the combined trafficable width of the passing bay and constructed private driveway to be a minimum 6 m); and
- Turn-around areas as shown in Figure 14.

A3.7 Signage

Signage to be provided within the subject site, advising of where each access route travels to and the distance and general information signs on what to do in the event of a bushfire.



ELEMENT 4: WATER SUPPLY FOR VULNERABLE TOURISM LAND USES

SPP 3.7 OUTCOMES

ACCEPTABLE SOLUTIONS

O4 Ensure that sufficient water is available to enable people, property and infrastructure to be defended from bushfire

A4.1 Water supply

Where a reticulated water supply is existing or proposed, a hydrant connection(s) should be provided in accordance with the specifications of the relevant water supply authority.

Where these specifications cannot be met, a water tank(s) should be provided in accordance with the requirements of Appendix A.4, Table 5 – Water supply dedicated for bushfire firefighting.



10 ROLES AND RESPONSIBILITIES

The management of bushfire related risk is the shared responsibility of landowners/proponents, government, industry and the community. This section summarises the key authorities and stakeholders, and their respective responsibilities in implementing SPP 3.7 and the Guidelines.

10.1 LANDOWNERS/PROPONENTS

Landowners/proponents responsibilities in addressing SPP 3.7 and the Guidelines include:

- awareness of the bushfire threat to their life and property and understanding that the bushfire risk in most circumstances cannot be entirely avoided or removed
- preparing and implementing contingency and emergency evacuation measures in case a bushfire occurs onsite or nearby
- responding to and complying with fire protection or hazard management notices issued by the local government
- seeking the services of an accredited Level 1 BAL assessor or accredited bushfire planning practitioner to:
 - prepare a BHL, BAL Contour Map and/or BAL assessment to support their planning application, in accordance with SPP 3.7 and the Guidelines

- where applicable, prepare a bushfire management plan, to demonstrate compliance with the bushfire protection criteria outlined in the relevant sections of the Guidelines
- where applicable, prepare a Bushfire Emergency Plan for vulnerable land uses
- seeking the services of a planning or environmental consultant to address environmental considerations within the bushfire management plan, including:
 - identifying Environmentally Sensitive Areas with significant environmental conservation values
 - identifying vegetation that requires clearing or modification and where necessary providing a flora assessment to support the application
 - consulting with local government about locally significant native vegetation
 - providing an appropriate buffer for strategic planning proposals, subdivision or development applications abutting waterways and wetlands
- consulting early with relevant State and local government agencies, in circumstances where elements of their proposal may not conform to the acceptable solutions in the bushfire protection criteria
- ensuring the ongoing implementation of any bushfire management plan, including the ongoing management of any Asset Protection Zone, maintenance of a water source for firefighting (if applicable) and ensuring internal access provisions are provided (including trimming tree branches back that overhang a driveway).

10.2 LOCAL GOVERNMENTS

Local government's responsibilities in addressing SPP 3.7 and the Guidelines may include:

- ensuring strategic planning proposals, structure plans and development applications located in designated bushfire prone areas address SPP 3.7 and the Guidelines
- administering development controls in accordance with the local planning scheme, with due regard to SPP 3.7 and other policies and publications outlined in these Guidelines
- preparing a water distribution plan that identifies existing strategic water tanks for the use in the event of a bushfire and to assist with the identification of new strategic water tanks necessary to support new development. This should be done through the Local Emergency Management Committee
- seeking the advice of DPLH and DFES on bushfire local planning policies and supplementary provisions to the deemed provisions relating to bushfire risk management contained in the LPS Regulations 2015
- ensuring related documents, such as local biodiversity strategies, revegetation and/or environmental management plans have been considered in the bushfire management plan and ensuring revegetation is considered in the bushfire assessment and does not increase the bushfire risk
- seeking comments and advice from DFES in relation to:
 - all strategic planning proposals within bushfire prone areas
 - all vulnerable land uses



- applications that propose an outcomes-based approach
- seeking advice from the appropriate agency if the bushfire management plan proposes modification or impacts on an environmentally sensitive area including a waterway/wetland, coastal foreshore or proposes clearing native vegetation
- providing advice where the clearing of locally significant vegetation is proposed
- advising DFES of recommended amendments to the *Map of Bush Fire Prone Areas* in accordance with the *Mapping Standard for Bush Fire Prone Areas* where:
 - there is no apparent bushfire prone vegetation (for example, where a BAL Contour Map or BAL assessment indicates a section of land as BAL-LOW)
 - clearing has been undertaken in accordance with a subdivision or development application
 - there are inconsistencies between the *Map of Bush Fire Prone Areas* and local government mapping
 - an area is proposed to be developed in a way that introduces a bushfire hazard (for example, it incorporates the revegetation of cleared land, wetlands or foreshores)
- ensuring a final compliance check against the implementation table within the bushfire management plan has been undertaken by the BAL assessor, bushfire planning practitioner and/or local government, upon completion of subdivisional works
- ensuring landowners/occupiers comply with the ongoing management actions within the bushfire management plan implementation table

- applying the precautionary principle to all strategic planning proposals, subdivision and development applications in bushfire prone areas
- ensuring buildings are constructed in accordance with the determined BAL rating and associated bushfire construction requirements where required.

10.3 WESTERN AUSTRALIAN PLANNING COMMISSION/DEPARTMENT OF PLANNING, LANDS AND HERITAGE

The WAPC/DPLH is responsible for:

- assessing and determining higher order strategic planning proposals, strategic planning proposals, subdivision and development applications in accordance with SPP 3.7 and the Guidelines
- applying the precautionary principle to all strategic planning proposals, subdivision and development applications in bushfire prone areas
- monitoring the implementation and effectiveness of SPP 3.7 and the Guidelines.
- reviewing SPP 3.7 and the Guidelines, as necessary
- ensure consistent consideration and determination of those applications that are inconsistent with the advice of DFES and/or do not satisfy the acceptable solutions of the bushfire protection criteria, and/or propose an outcomes-based approach
- assessing proposed local government supplementary provisions to the deemed provisions relating to bushfire risk management contained in the LPS Regulations 2015, in consultation with DFES, if required

- assessing local government requests for local variations to the bushfire protection criteria
- seeking DFES' comments and advice in relation to:
 - bushfire local planning policies
 - where a local government seeks to make local variations to the bushfire protection criteria
 - bushfire management plans that propose an outcomes-based approach to the bushfire protection criteria
 - where a Method 2 assessment has been undertaken in accordance with AS 3959
 - strategic planning proposals, including regional and local planning schemes, scheme amendments and structure plans, where SPP 3.7 and the Guidelines apply and where a bushfire management plan has been prepared
 - applications for vulnerable, including tourism, land uses
- referring bushfire management plans that are close to waterways/wetlands or impact on significant vegetation to the appropriate agency for comment
- advising DFES of recommended amendments to the *Map of Bush Fire Prone Areas* in accordance with the *Mapping Standard for Bush Fire Prone Areas* where an area is proposed to be developed in a way that introduces a bushfire hazard (for example, it incorporates the revegetation of cleared areas, wetlands or foreshores).



10.4 DEPARTMENT OF FIRE AND EMERGENCY SERVICES

The Fire and Emergency Services Commissioner is responsible for designating bushfire prone areas to trigger planning and building requirements under the *Fire and Emergency Services Act 1998* (as amended). DFES is responsible for fire management across the State.

DFES provide technical fire-related advice to help guide decision-making on strategic planning proposals, subdivision and development applications. DFES is responsible for providing referral advice detailing their assessment against SPP 3.7 and the Guidelines to the decision-maker within statutory timeframes, where:

- a strategic planning proposal is required to address SPP 3.7 and the Guidelines and where a bushfire management plan has been prepared
- a strategic planning proposal, subdivision or development application proposes an outcomes-based approach to the bushfire protection criteria contained within these Guidelines
- a Method 2 assessment has been undertaken in accordance with AS 3959
- a strategic planning proposal, subdivision application or development application contains a vulnerable land use, including a tourism land use as specified in SPP 3.7 and the Guidelines
- a local government proposes a local planning scheme amendment containing supplementary provisions in addition to the deemed provisions relating to bushfire risk management contained in the LPS Regulations 2015

- a bushfire local planning policy, or variation to the acceptable solutions or the Asset Protect Zone standards is proposed
- there is a conflict of opinion between the decision-maker and/or the landowner/proponent concerning a bushfire management plan or bushfire assessment.

If a subdivision or development application meets all the acceptable solutions and does not otherwise trigger a referral as listed above, the advice of DFES is not required.

DFES is also responsible for providing:

- technical advice on bushfire behaviour and emergency management procedures to decision-makers in cases where refusal of the strategic planning proposal, subdivision or development application is recommended
- expert technical evidence, including representation of DFES, is required for the State Administrative Tribunal on bushfire risk and its consequences to planning decisions
- expert technical evidence, including representation of DFES, is required for Development Assessment Panels on bushfire risk and its consequences to planning decisions
- expert technical advice on other occasions where bushfire technical advice is required to support planning decision-making.

10.5 OFFICE OF BUSHFIRE RISK MANAGEMENT

The Office of Bushfire Risk Management (OBRM) is a branch within the Rural Fire Division of DFES. The Fire and Emergency Services (FES) Commissioner is the employing authority. The FES Commissioner and OBRM are responsible for:

- setting standards addressing strategic bushfire risk management, including the development of the *Map of Bush Fire Prone Areas* and the *Mapping Standard for Bush Fire Prone Areas*
- reviewing the *Map of Bush Fire Prone Areas* and associated standards
- facilitating the coordination of key authorities on the management, auditing and reporting of bushfire-related risk matters.

10.6 DEPARTMENT OF MINES, INDUSTRY REGULATION AND SAFETY (BUILDING AND ENERGY DIVISION)

The Department of Mines, Industry Regulation and Safety is responsible for:

- administering the *Building Act 2011* and *Building Regulations 2012* that set out the building approval process for Western Australia, including the requirement to obtain a building permit to carry out building work
- administering and applying the Building Code of Australia in Western Australia
- responding to general enquiries about the application of the Building Code of Australia



- registering builders and building surveyors
- auditing building work and registered practitioners (such as builders and building surveyors)
- providing a dispute resolution process for complaints about registered practitioners.

10.7 DEPARTMENT OF CLIMATE CHANGE, ENERGY, THE ENVIRONMENT AND WATER (AUSTRALIAN GOVERNMENT)

The Australian Government's Department of Climate Change, Energy, the Environment and Water protect Australia's natural environment and heritage sites, respond to climate change and manage water and energy resources. The Department administers the *Environmental Protection and Biodiversity Conservation Act 1999* (EPBC Act 1999). Under the *EPBC Act 1999*, a strategic planning proposal, subdivision and development application requires referral to the Department for assessment if it has, or is likely to have, a significant impact on matters of national environmental significance, such as nationally and internationally important flora, fauna, ecological communities and heritage places.

10.8 DEPARTMENT OF WATER AND ENVIRONMENTAL REGULATION

The Department of Water and Environmental Regulation (DWER) is responsible for:

- assessing vegetation clearing proposals associated with land development

- providing referral advice on the management of water resources in accordance with Better Urban Water Management (WAPC 2008) and water resource management legislation, policies and guidelines
- determining whether to assess region or local planning schemes, scheme amendments or development applications in order to protect the environment.

10.9 DEPARTMENT OF BIODIVERSITY, CONSERVATION AND ATTRACTIONS

The Department of Biodiversity, Conservation and Attractions (DBCA) is responsible for implementation of the *Biodiversity Conservation Act 2016* and *Biodiversity Conservation Regulations 2018* and providing referral advice on applications abutting reserves and land under its management, including State land that is managed by agreement with the DPLH, WAPC and/or local government. DBCA considers biodiversity, flora and fauna, wetlands and ecological communities as well as nature conservation covenants on freehold land and fire management issues within adjoining reserves. General conservation enquiries should be directed to DBCA.

10.10 STATE ADMINISTRATIVE TRIBUNAL

The State Administrative Tribunal reviews decisions made by government where it is empowered to do so by State legislation. The *Planning and Development Act 2005* and local planning schemes give power to State Administrative Tribunal to review decisions made pursuant to the *Planning and Development Act 2005*, local and regional planning schemes and the *Metropolitan Redevelopment Authority Act 2011*.



ACRONYMS

WAPC	Western Australian Planning Commission
DPLH	Department of Planning, Lands and Heritage
DMIRS	Department of Mines, Industry Regulation and Safety
DFES	Department of Fire and Emergency Services
BCA	Building Code Australia
BMP	Bushfire Management Plan
BEP	Bushfire Emergency Plan
NCC	National Construction Code
BAL	Bushfire Attack Level
BLA	Broader Landscape Assessment
BHL	Bushfire Hazard Level



DEFINITIONS

All-weather surface: Compacted gravel surface to the standard prescribed in the Austroads Guide to Pavement Technology as a minimum. An all-weather surface does not need to be sealed.

Aspect: The four cardinal (north, south, east and west) or intercardinal (northeast, southeast, northwest and southwest) directions a site is exposed to.

Asset protection zone: A low fuel area maintained in accordance with Table 3 of these Guidelines around a building to increase the likelihood that it will survive a bushfire. Its size is dependent on adjacent vegetation and slope.

Bushfire Attack Level (BAL): Bushfire Attack Level (BAL) as set out in the *Australian Standard 3959: Construction of buildings in bushfire-prone areas*, as referenced in the Building Code of Australia (as amended).

BAL assessment: An assessment prepared in a manner and form set out in AS 3959 to determine a bushfire attack level (BAL).

BAL Contour Map: A BAL Contour Map is a scale map of the subject lot(s) illustrating the potential radiant heat impacts and associated indicative BAL ratings in reference to classified vegetation. The intent of the BAL Contour Map is for land use planning purposes and to identify land suitable for development based on the potential BAL, not for final determination of the BAL.

Broader landscape: The landscape characteristics, including vegetation type and distribution, slope and vehicular access within at least 2 kilometres from the subject site that provides an indication of the risk and intensity of a potential bushfire.

Building Code of Australia: Means Volumes One and Two, as amended from time to time, of the National Construction Code series published by, or on behalf of, the Australian Building Codes Board.

Building envelope: The area of land within which all buildings and effluent disposal facilities on a lot must be contained, as defined in the *Planning and Development (Local Planning Schemes) Regulations 2015*.

Bushfire: An unplanned fire burning in vegetation. A generic term which includes grassfire, forest fires and scrub fires.

Bushfire hazard: The potential or existing flammability of vegetation that, in association with topography and slope, when ignited may cause harm to people and/or damage property and/or infrastructure.

Bushfire hazard issues: Issues identified in a bushfire management plan as a result of an examination of the results of the bushfire assessment, environmental considerations and broader landscape (where necessary), for a planning proposal. Identified issues are to be addressed through the bushfire protection measures and/or may need special consideration.

Bushfire Hazard Level (BHL) assessment: A pre- or post-development assessment that provides a measure of the likely intensity of a bushfire and the likely level of bushfire attack on a site determined by categorising and mapping land as having a low, moderate or extreme BHL in accordance with the methodology set out in the Guidelines.

Bushfire Management Plan: A document that sets out short, medium and long-term risk management strategies for the life of the development.

Bushfire Planning Practitioner: A person who holds, Level Two or Three accreditation under the [Western Australian Bushfire Accreditation Framework](#).

Bushfire prone area: An area that has been designated by the FES Commissioner under s. 18P of the *Fire and Emergency Services Act 1998* as an area that is subject, or likely to be subject, to bushfires.

Bushfire protection criteria: An outcomes-based system of assessing bushfire risk management measures contained in these Guidelines.

Bushfire resilient community: A community that is likely to suffer less during a bushfire and is likely to be able to withstand and recover quickly, financially and physically, from the negative impacts of a bushfire.

Bushfire risk: The chance of a bushfire igniting, spreading and causing damage to people, property and infrastructure.

Bushfire risk management: The application of the bushfire protection criteria contained in the Planning for Bushfire Guidelines.

Carriageway: A portion of a road that is improved, designed or ordinarily used for vehicular traffic.

Clearing: The removal or modification of native vegetation, as defined in the *Environmental Protection Act 1986* section 51A.



Community use: A use that provides a community or civic function, such as an education establishment, aged or assisted care, nursing homes, community halls, hospitals.

Decision-maker: The Minister for Planning, State Administrative Tribunal, Western Australian Planning Commission, Development Assessment Panel, any other state decision making authorities, and/or relevant local government and their delegates that make decisions regarding the application of this policy, in accordance with the *Planning and Development Act 2015*.

Defendable space: An area of land around a building where vegetation (and other fuels) is managed to reduce the effects of flame contact and radiant heat associated with a bushfire and provides a relatively safe space from which firefighters and appropriately prepared homeowners may defend the property.

Determined BAL: The BAL rating provided in accordance with *AS 3959: Construction of buildings in bushfire-prone areas*, that is based on current site conditions, without the need for any modifications to the site or surrounds to occur.

Development application: An application for approval to carry out development or change a land use under either a local planning scheme or region planning scheme and includes local development plans.

Development site: Means that part of a lot on which a building(s) that is the subject of development stands or is to be constructed, as defined in the *Planning and Development (Local Planning Schemes) Regulations 2015*, section 78A.

Evacuation: The urgent movement of people temporarily to safer places before or during the occurrence of a hazardous event, when conditions may be so hazardous that sheltering-in-place would place people in greater danger.

Greenfield: Undeveloped land that has been identified for future urban use, usually on the urban periphery or within rural area.

Guidelines: Refers to the *Planning for Bushfire Guidelines* (WAPC 2023, as amended).

Habitable Building: Means a permanent or temporary structure on land that –

- a. Is fully or partially enclosed; and
- b. Has at least one wall of solid material and a roof of solid material; and
- c. Is used for a purpose that involves the use of the interior of the structure by people for living, working, studying or being entertained,

as defined in the *Planning and Development (Local Planning Schemes) Regulations 2015*, section 78A.

Hazard separation: Separation of a development site from vegetation classified under *AS 3959* to assist in preventing the spread of bushfire to buildings. Hazard separation is usually in addition to an Asset Protection Zone, and includes hard surfaces, including roads and footpaths, waterways and public open space that is managed in a low threat state, in accordance with *AS 3959: Construction of buildings in bushfire-prone areas*.

Horizontal clearance: The trafficable and traversable surface that provides for the movement and parking of vehicles and area required by emergency services to operate. It includes the trafficable unsealed/sealed road pavement, traversable shoulders and verge treatments. Frangible obstructions can be within the verge treatments.

Higher order strategic planning including regional and sub-regional frameworks, region schemes, sub-regional strategies, district structure plans and local planning strategies.

Indicative BAL: A BAL rating that could be achieved within a site, based on future measures such as clearing, development or thinning of vegetation occurring.

Infill: The development of land surrounded by existing urban areas, generally to a higher density than currently exists. Infill includes the re-development of land that has been previously built on (brownfield sites).

Intensification: A planning proposal that would expose a greater number of individuals to a bushfire. This may be the result from development at a larger scale than what is currently existing; and/or a change in land use that would allow more occupants on the site, or activities occurring more frequently on the site and/or for longer periods.

Landscape scale bushfire: Extreme fire behaviour influenced by topographical features such as long areas of continuous vegetation and steep slopes. Landscape scale bushfires are difficult to defend and control and often last for a number of days.

Level 1 BAL assessor: A person who holds Level 1 BAL assessor accreditation under the *Western Australian Bushfire Accreditation Framework*.

No-through road: A cul-de-sac or dead-end road.

Off-site shelter: Another location, some distance away from the site that is able to accommodate all the people being evacuated. The place is not under threat from a bushfire.

On-site shelter: An on-site location where people facing an immediate threat to their personal safety or property can gather and seek shelter from the impact of a bushfire.



Plant flammability: The characteristics and properties of plant species that have a direct correlation with flammability, such as moisture content.

Precautionary principle: The presumption against approving further strategic planning proposals, subdivision and development applications, where there is a lack of sufficient certainty that potentially significant adverse impacts can be adequately reduced or managed.

Residual bushfire risk: Risk remaining after applying mitigation measures.

Risk treatment: The partial or complete removal of a risk source or some improvement in the controls to reduce the level of risk.

Short-term accommodation: Temporary accommodation provided either continuously or from time to time with no guest accommodated for periods totalling more than 3 months in any 12 month period, as defined in the Planning and Development (Local Planning Schemes) Regulations 2015.

Site constraints: A physical component affecting a site that restricts the ability of the site to address the bushfire protection measures listed in the Guidelines. It may include a physical feature within or adjacent to a site that constrains the ability to re-design the planning proposal as the feature itself cannot be re-located and/or could relate the shape of the subject lot.

Strategic planning proposal: Any strategic-level planning proposal includes local planning schemes and amendments and structure plans but does not include subdivision and development applications.

Subject site: The entirety of the lot(s), subject to and affected by the planning proposal.

Suitable destination: An area that is not designated as bushfire prone on the *Map of Bush Fire Prone Areas* or is greater than 100 metres from classified vegetation, or 50 metres from Class C Grassland, as per AS 3959 and can provide protection during and after a bushfire event.

Tolerable: The willingness to live with a risk to secure benefits and achieve objectives, on the understanding that it is being properly controlled. 'Tolerability' does not mean 'acceptability'. Tolerating a risk does not mean that it is regarded as negligible, or something we may ignore, but rather as something that needs to be kept under review and reduced further.

Trafficable: Can be travelled upon by vehicles at the posted speed limit.

Two-way access: Vehicular access from a site in two different directions to at least two different suitable destinations.

Type 3.4 firefighting appliance: A 4x4 tanker with a 3000 litre water tank capacity used for firefighting.

Unacceptable bushfire risk: A level of risk that is so high that bushfire mitigation measures are not considered appropriate and only avoidance enables the elimination of the risk.

Vulnerable land use: A land use which:

- is designed to accommodate people who are less physically or mentally able and likely to present evacuation challenges and/or
- due to the building design or use, or the number of people accommodated, likely to present evacuation challenges and/or
- involves visitors who are unfamiliar with the surroundings.

Examples are provided within the Guidelines.

Weight capacity: Applies to the trafficable surface construction, including all bridges or culverts on the site and access routes.



BUSHFIRE PROTECTION CRITERIA EXPLANATORY NOTES

A.1 LOCATION

A.1.1 UNDERSTANDING SIZE AND INTENSITY OF BUSHFIRE

Appendix B.1: Broader landscape assessment methodology defines how vegetation is categorised, to understand the likely size and intensity of a bushfire and to determine the broader landscape type surrounding the planning proposal. The vegetation categories used in this methodology simplify those in AS 3959 and have been developed to provide a broad-scale understanding of the bushfire hazard. The basis for identifying these vegetation categories is to inform the likely fire behaviour that may arise from different vegetation types.

AS 3959 should assist with understanding the underlying vegetation types but the assessment should spatially delineate the categories identified in Appendix B.1. The assessment should contain a level of detail appropriate to the nature and scale of the proposal in relation to its contextual setting.

The assessment is primarily concerned with classified vegetation (excluding Class G Grassland) that presents a risk of supporting a landscape scale bushfire, which could result in a significant loss of property and life, such as large areas of state forest and reserves.

As a general guide, a continuous stretch of vegetation, classified under AS 3959 of 1 kilometre or more and 100 metres or more in width, has the potential to result in a landscape scale bushfire potentially resulting in loss

of property and life. However, Class G Grassland can burn quickly with less ember attack and can generally be mitigated through the use of an APZ and/or hazard separation, such as a perimeter road.

A.1.2 TRAFFIC ANALYSIS

For a Broader Landscape Type C, where the existing adjoining town or urban area does not achieve two public access routes to two suitable destinations, a traffic assessment should be prepared by a qualified transport planner or engineer. The assessment should demonstrate that the existing and proposed road network has capacity for the evacuation of existing and new residents, and access for emergency services vehicles, in the event of any bushfire. It will be important to clearly demonstrate the proposed development maintains or improves the evacuation capacity of the road network in the event of a bushfire and does not make the current situation worse.

This may include contributions or improvements to the existing road network, where access is required. In addition to analysing the proposed details of the subject or development site(s), the traffic analysis should use a catchment-based approach that contemplates traffic movements from the wider area. This approach should be included in the traffic models used within the assessment.

The bushfire planning practitioner and the transport planner or engineer will need to collaborate to incorporate parameters that consider the identified bushfire scenarios. The following should be considered within the assessment:

- A range of evacuation timeframes for each scenario. For example, off-peak times such as Sunday afternoons when there may be higher occupancy within a residential area, which could cause greater congestion in an emergency evacuation, compared to traffic flow during a peak hour on a weekday.
- Timeframes that reflect evacuation movements of people. For example, how many people will leave two hours before, one hour before, 20 minutes before a bushfire emergency. These numbers will impact the volumes in the traffic model.
- Impact of seasonal variations such as school holidays or the peak tourism season.
- Typical vehicles in a specific area, such as horse floats or trailers in a rural area.
- Unfamiliar road networks.
- In some locations, fire authorities will know which roads will close at what point and triggers will be in place or be known.
- Effects of smoke on visibility and reduced evacuation speeds.
- Fire danger ratings and the effect on evacuation. Under the National Fire Danger Rating system, people will be asked to leave for a safer place on catastrophic danger days.
- Some intersections will operate on contraflow but this cannot be guaranteed. Any reliance on emergency services changes to traffic flow need to be avoided in the modelling as these situations cannot be guaranteed.



- The point at which evacuation is no longer an option. This may be the time from ignition to the point where evacuation is no longer an option, or how long it will take for warnings to be provided, those warnings to be received and decisions made to leave.

A.1.3 UNDERTAKING AN OUTCOMES-BASED APPROACH FOR ELEMENT 1 – LOCATION

SPP outcome for Element 1: location – Avoid broader landscapes that present an unacceptable bushfire risk to people, property and infrastructure.

A.1.3.1 Methodology

An outcomes-based approach is detailed in policy measure 7.4 of SPP 3.7 and Section 3 of the Guidelines. The methodology used for an outcomes-based approach will be up to the bushfire practitioner, however, it is recommended that discussions are held with the decision-maker prior to preparation of the bushfire management plan (BMP).

The chosen methodology needs to be clear and transparent, as well as being replicable, robust and, where possible, supported by evidence. Not all methodologies are suitable for land use planning purposes and there are limitations on applying the methodologies listed below to planning proposals. Practitioners may adapt methodologies where necessary to ensure that they are appropriate to the scale and purpose of the assessment. Where the methodology is adapted, what has changed and why must be clearly stated, to ensure transparency.

Examples of methodologies or documents that may be useful include:

- [National Emergency Risk Assessment Guidelines \(NERAG\)](#)
- [ISO 31000:2018 – Risk management](#)
- [Sendai Framework for Disaster Risk Reduction 2015-2030](#)
- [Queensland Fire and Emergency Services Risk Assessment Process Handbook](#)
- [Generalised extreme value analysis](#)
- [Australian Institute for Disaster Resilience \(AIDR\) Land Use Planning for Disaster Resilient Communities](#)
- [AIDR Evacuation Planning Handbook](#)

A.1.3.2 Bushfire scenario planning

Scenario planning for bushfires is a useful way to examine the potential impact a bushfire will have around or within the planning proposal. Bushfire scenarios can consider the dimensions and characteristics of a bushfire flame, its initiation, spread and development, which arise from assumed weather conditions, topography and fuel (vegetation) in a given setting.

An output of scenario planning is the formulation of map(s), which provide a useful visual representation for decision-makers. These maps should spatially identify:

- the direction a landscape-scale fire run(s), which could impact the planning proposal
- bushfire scenarios through differing contiguous extents of vegetation
- aspects and sections of the planning proposal to exposed interfaces with bushfire hazards

- potential impact of direct attack mechanisms such as radiant heat, ember and surface fire attack
- whether a bushfire has the ability to run into and through the subject site
- the interaction between the internal and external broader landscape bushfire hazards.

In addition to the information above, the assessment should include:

- consideration or acceptance of ember load modelling and/or smoke hazard
- a transport impact assessment
- provision of additional mitigation measures where applicable
- a vulnerability assessment of and discussion on how the planning proposal reduces the bushfire risk to 'As low as reasonably practicable' (ALARP).

It is noted that the impact of particular bushfire hazards will be different, including the long-range impact of ember attack and smoke hazard. Where possible, the practitioner may consider ember load modelling to show the extent of the potential affected area on or around the site from different bushfire scenarios. Where ember attack or ember load and/or smoke modelling is not undertaken to inform hazard identification, a general acceptance of the presence and/or relevance of these two mechanisms can be adopted.

A.1.3.3 Vulnerability assessment

A vulnerability assessment may prove to be useful in some situations, including where the planning proposal involves large numbers of people. The vulnerability assessment



can consider how the identified bushfire hazards are likely to impact on people and the proposed development or assets (buildings and infrastructure), including consideration of the function assets can have in protecting human life. It assigns the degree to which people and assets are susceptible to the adverse effects of a bushfire.

A vulnerability assessment should consider the details of the proposed occupants or users of the future site, future building construction standards, and access and egress available to and within the site. An ALARP approach should be taken to achieve the best outcome. This approach aims to reduce the bushfire risk(s) as much as reasonably possible given practicalities in application of the approach and site constraints.

A.1.3.4 Additional mitigation measures

Additional mitigation measures should be identified in circumstances where the bushfire protection criteria do not appropriately respond to the identified bushfire threats, and particularly when developing an outcomes-based approach for those sites identified as Broader Landscape Type C.

It is up to the practitioner to justify why each mitigation measure is considered effective to appropriately mitigate the threat to the development and can be implemented, in perpetuity. Application of a greater number of mitigation measures may not equate to a lower level of vulnerability in all instances.

Examples of additional mitigation measures are identified in Table 2. This list is not exhaustive and measures listed may not apply to all planning stages. It is up to the practitioner to include what is appropriate for the site and

to justify each measure's inclusion, as well as to provide other measures they deem suitable, which may not be listed below.

Mitigation measures should be assessed in terms of their:

- potential benefits
- effectiveness in reducing losses or maximising opportunities
- impact on other objectives, including the introduction of new threats or issues
- practicality
- reversibility/adaptability
- effectiveness over time
- implementation certainty and timing
- ongoing management and compliance reporting
- acceptance by community, stakeholders and decision-makers
- legal and approval barriers.



Table 2: Examples of additional mitigation measures

OPTION CATEGORY	MITIGATION MEASURE	HOW IT WILL HELP	EXAMPLE OF MITIGATION ANALYSIS	POTENTIAL ASSETS
Avoid	Within the site, locating assets in areas of lowest risk to the bushfire hazard.	Assets will not be vulnerable to risk arising from bushfire hazard.	Persons and assets are not directly exposed to bushfire hazard or risk.	All or specific assets.
Built form, design and layout	The facility's buildings incorporate bushfire-resilient design features (beyond construction requirements).	Design features of buildings can effectively mitigate aspects of bushfire attack. Resilient design principles are incorporated into the architectural design of assets.	Simple built forms, including roof forms, are adopted that avoid re-entrant corners and complex roof forms that may entrap embers.	Whole development or selected buildings.
	Buildings are sufficiently separated from each other to limit the potential for building-to-building ignition.	Site layout considers the potential for building-to-building ignition and separates buildings, or groups of buildings, to limit risk. A detailed assessment to support this will be required.	The site layout is rationalised to limit building-to-building ignition, employing built form separation.	Whole development or selected or groups of buildings.
	Restricting or limiting the siting of dwellings in the landscape context.	Dwellings may have a lower exposure to bushfire risk.	Restricting dwelling construction on ridges even where a BAL-29 rating may be achieved.	Whole development or selected buildings.
Building construction	Construction to AS 3959 (or NASH Bushfire Standard) at a higher standard than required by the radiant heat flux profile (see additional construction measures).	Voluntary heightening of BAL construction standards other than those prescribed by the assessment methodologies of AS 3959 or the NASH Bushfire Standard to facilitate a higher level of potential protection.	Financial investment in construction to higher construction standard may increase the ability for the asset to withstand bushfire attack.	Selected buildings.
Access and egress (evacuation)	The capacity of the on-site and surrounding road network can support evacuation processes, either in leaving early or in an emergency, in conveying people to a safe location (note: traffic analysis may be required to demonstrate this risk mitigation measure).	The development does not create bottleneck situations where vehicles may be trapped on the road network during an event, or subject to an existing bottleneck on the broader road network on which the development seeks to rely.	A traffic analysis demonstrates vehicles will not be standing on the road network at the time of fire front arrival.	Whole development.
	Where accessed by an unsealed road, the road enables two-way traffic flow and is not obstructed by low bridges, gates or involve sharp turns or steep drop-offs.	Unsealed roads are designed and constructed to provide safe passage during an evacuation.	The road network is capable of safely carrying evacuating traffic in an emergency with reduced risk of road accidents occurring.	Whole development.



OPTION CATEGORY	MITIGATION MEASURE	HOW IT WILL HELP	EXAMPLE OF MITIGATION ANALYSIS	POTENTIAL ASSETS
	The facility includes its own on-site vehicles that can be used to assist evacuation (i.e. tour vehicles, minibuses, troop carriers, etc.) for occupants with poor mobility or unable to follow instructions.	Access to exclusive vehicle fleet may assist efficient evacuation of guests and staff without relying on buses or other vehicles for groups of guests who do not have access to private vehicles. This may apply to tour groups and other groups of guests.	Adequate provision of vehicles to meet the capacity of the development.	Whole development.
Water supply and firefighting infrastructure	For facilities connected to reticulated water supplies, additional static water supplies are provided on-site as redundancy.	Electricity can fail during bushfire emergencies, which limits operation of water pumping stations and other infrastructure. On-site static water supply sources for explicit use of firefighting ensures water availability. Petrol or diesel-fuelled pumps are required. Alternatively, solar or other renewable energy sources could be contemplated to ensure pumping ability.	Water supply redundancy is achieved via the provisions of water tanks for the exclusive purpose of firefighting should mains supply fail.	Whole development or selected buildings.
	Where electric pumping equipment is used, an onsite back-up power source is provided, with reserves to provide power for at least four hours	Provide additional power supply when main power source fails, which is generally common in a bushfire event.	Loss of power supply from main source and back-up power is used to pump water supply from the water source.	Whole development.
	Suitable fire suppression sprinklers and associated infrastructure attached to buildings internally and/or externally	Provision of suitable suppression sprinklers and associated water supply to wet buildings ahead of bushfire. Mitigate house-to-house flame contact.		Whole development or selected buildings.
	Firefighting infrastructure such as (but not limited to) hydrants (flows and pressures that meet local requirements), pumps and high-pressure hoses that can reach all external facades of the buildings, and appropriate fire brigade fittings to static supplies.	Firefighting infrastructure supports the development and its buildings and occupants to be defended, where safe to do so.	Firefighting equipment is available for asset defence, only under certain conditions.	Whole development or selected buildings.

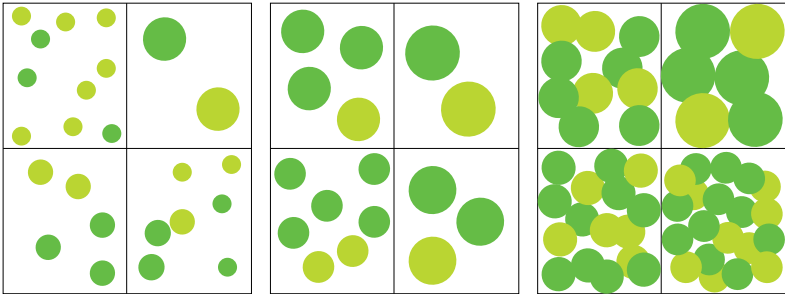


OPTION CATEGORY	MITIGATION MEASURE	HOW IT WILL HELP	EXAMPLE OF MITIGATION ANALYSIS	POTENTIAL ASSETS
Protection measures	Power is provided underground.	Overhead powerlines are a known ignition source. Electricity servicing the development is provided underground.	Opportunity for ignition from overhead powerlines is avoided.	Whole development or selected buildings.
	Landscaping is based on bushfire resilient principles and plant flammability.	Site-based landscape can contribute to fire propagation immediately adjacent to buildings and evacuation routes. Careful plant flammability considerations seek to limit vertical and horizontal propagation of fire within the site and does not contribute to a worsening level of risk.	Potential propagation within the site is reduced through careful plant flammability considerations in landscaping. A landscape concept plan that informs this is required. An ongoing management plan is required.	Whole development.
	Land management practices are identified within the site to manage fuel loads and balance ecological values.	Fuel and hazard management such as prescribed burning and mechanical treatments are employed on the site to manage on-site fuel loads where clearing is not proposed.	On-site fuels are managed appropriately to limit fuel build-up and provide fuel managed/reduced zones around the development.	Whole development.
	Fencing and retaining walls are constructed of stone, masonry, concrete or other non-combustible material.	Fire-resistant retaining walls will ensure ground stabilisation during and post-fire. It also ensures retaining features do not inadvertently contribute to fire propagation internal to the site.	Fencing and retaining walls are unable to carry fire into or across the site, applying radiant heat or propagation effects internal to the site.	Whole development.



A.2 SITING AND DESIGN

Table 3: Asset Protection Zone (APZ) technical requirements

OBJECT	REQUIREMENT
Fences within the APZ	Should be constructed from non-combustible materials (for example, iron, brick, limestone, metal post and wire, or bushfire-resisting timber referenced in Appendix F of AS 3959).
Fine fuel load (combustible, dead vegetation matter less than 6 mm in thickness)	<ul style="list-style-type: none"> • Should be managed and removed on a regular basis to maintain a low threat state • Should be maintained at less than 2 tonnes per hectare (on average) • Mulches should be non-combustible such as stone, gravel or crushed mineral earth or wood mulch more than 6 mm in thickness.
Trees* (more than 6 m in height)	<ul style="list-style-type: none"> • Trunks at maturity should be a minimum distance of 6 m from all elevations of the building • Branches at maturity should not touch or overhang a building or powerline • Lower branches and loose bark should be removed to a height of 2 m above the ground and/or surface vegetation. • Canopy cover within the APZ should be less than 15 per cent of the total APZ area • Tree canopies at maturity should be at least 5 m apart to avoid forming a continuous canopy. Stands of existing mature trees with interlocking canopies may be treated as an individual canopy provided the total canopy cover within the APZ does not exceed 15 per cent and is not connected to the tree canopy outside the APZ. <p data-bbox="638 1023 1348 1050">Tree canopy cover – ranging from 15 to 70 per cent at maturity</p>  <p data-bbox="734 1385 786 1406">15%</p> <p data-bbox="1003 1385 1055 1406">30%</p> <p data-bbox="1272 1385 1323 1406">70%</p>



OBJECT	REQUIREMENT
Shrub* and scrub* (0.5 m to 6 m in height). Shrub and scrub more than 6 m in height are to be treated as trees.	<ul style="list-style-type: none"> • Should not be located under trees or within 3 m of buildings • Should not be planted in clumps more than 5 m² in area • Clumps should be separated from each other and any exposed window or door by at least 10 m.
Ground cover* (less than 0.5 m in height. Ground cover more than 0.5 m in height is to be treated as shrub)	<ul style="list-style-type: none"> • Can be planted under trees but must be maintained to remove dead plant material, as prescribed in 'Fine fuel load' above • Can be located within 2 m of a structure but 3 m from windows or doors if more than 100 mm in height.
Grass	<ul style="list-style-type: none"> • Grass should be maintained at a height of 100 mm or less, at all times • Wherever possible, perennial grasses should be used and well-hydrated with regular application of wetting agents and efficient irrigation.
Defendable space	Within 3 m of each wall or supporting post of a habitable building; the area is kept free from vegetation but can include ground cover, grass and non-combustible mulches as prescribed above.
Liquid petroleum gas cylinders	<ul style="list-style-type: none"> • Should be located on the side of a building farthest from the likely direction of a bushfire or on the side of a building where surrounding classified vegetation is upslope, at least 1 m from vulnerable parts of a building • The pressure relief valve should point away from the house • No flammable material within 6 m from the front of the valve • Must sit on a firm, level and non-combustible base and be secured to a solid structure.

Notes:

* Plant flammability, landscaping design and maintenance should be considered – refer to following explanatory notes



EXPLANATORY NOTES

SPP outcome: Ensure siting and design solutions minimise environmental degradation and manages the bushfire risk to people, property and infrastructure.

A.2.1 IDENTIFYING AN APZ

An APZ is a low fuel area maintained around a building to increase the likelihood a building will survive a bushfire by reducing the potential for direct flame contact, radiant heat exposure and ember attack. The APZ allows emergency services access and provides an area for firefighters and home-owners to defend their property.

The width of an APZ should ensure the potential radiant heat impact of a bushfire does not exceed 29 kW/m² for a habitable building, or 10 kW/m² where a building is identified for use as an on-site shelter. Where a building or development site achieves 29k W/m² or lower in its pre-development state (prior to any vegetation clearing or modification), an APZ is generally not required. However, providing for the ongoing management of an APZ in perpetuity, in a low threat state, will ensure the BAL rating of the building does not increase over time.

At the subdivision stage where a lot contains a building envelope, and the development site(s) is yet to be determined, the BMP should demonstrate the lot(s) can achieve an indicative development site(s) of 29 kW/m² or below, within the building envelope.

It may not be necessary for an entire building envelope to achieve 29 kW/m² or lower, where this results in significant unnecessary clearing of vegetation.

An APZ should be contained within the boundaries of the lot on which the building is situated, except in instances where it is demonstrated the vegetation on the adjoining land is managed in a low threat state or is excluded under cl. 2.2.3.2 of AS 3959, such as a road, managed park, rocky outcrop or a water body. However, it should be noted there is no requirement for a neighbouring landowner or land manager (public or private) to be party to a legal agreement to undertake ongoing management of vegetation to a low threat state, in perpetuity.

Exclusion of vegetation on adjoining land, which is covered by a local government firebreak notice, issued under section 33 of the *Bushfires Act 1954*, may occur in limited circumstances at the development application stage. Where it is evident the adjoining landowner is managing the vegetation in accordance with the firebreak notice, a copy of the firebreak notice and photographic evidence of the managed vegetation should be included in a BMP. It will also be necessary to seek written confirmation from the local government, to confirm that it supports the exclusion.

A.2.1.1 Designing an APZ

An APZ should not be seen as an area entirely cleared of vegetation but as a strategically designed space that considers how existing and future mature vegetation and combustible and non-combustible features interact with and affect the building's resilience to bushfire.

An APZ should provide the greatest level of vegetation management within at least three metres of a building, to ensure adequate unobstructed defensible space for

emergency services to operate within. This area should contain minimal vegetation and be free of combustible materials and obstructions. Within the remainder of the APZ, planting of vegetation can increase as you move farther away from the building.

The placement of plants within an APZ is a key design technique. Separation of garden beds with areas of low fuel or non-combustible material will break up fuel continuity and reduce the likelihood of vegetation within an APZ supporting a bushfire. It is important to consider the plant density and final structure and form of plants in their mature state.

Strategic landscaping measures can be applied, such as replacing weeds with low flammability vegetation to create horizontal and vertical separations between the retained vegetation.

Mulches used within the APZ should be non-combustible. The use of stone, gravel, rock and crushed mineral earth is encouraged. Wood mulch more than 6 mm in thickness may be used, however, it is recommended that it is used in garden beds or areas where the moisture level is higher by regular irrigation.

Incorporation of landscaping features, such as masonry feature walls, can provide habitable buildings with barriers to wind, radiant heat and embers. These features can include noise walls or wind breaks. Use of Appendix F of AS 3959 for bushfire resistant timber selection or the use of non-combustible fencing materials such as iron, brick, limestone, metal post and wire is encouraged within an APZ.



A.2.1.2 Management of an APZ

Ongoing maintenance of an APZ is usually enforced through a condition of a subdivision or development approval, which should refer to Table 3 APZ technical requirements within this Appendix and/or through the local government firebreak notice.

Fine fuel load is the combustible, dead or dry vegetation matter found on the ground. Fine fuel should be maintained to less than 2 tonnes/ha. A simple method to estimate fine fuel load is to roughly equate 1 tonne of fuel load/ha, as 100 g/m². For example, 2 tonnes/ha of leaf litter is roughly 200 g of leaf litter/m². Eucalyptus leaf litter is approximately 100 g per handful, so two handfuls of leaf litter/m² will roughly equate to 2 tonnes/ha. Different types of fine fuel, such as mulch or pine needles may be more or less than a handful, however, the 100 g/m² rule of thumb can still be used.

In addition to regular maintenance of an APZ, further bushfire protection can be provided by:

- ensuring gutters are free from vegetation
- installing gutter guards or plugs
- regular cleaning of underfloor spaces, or enclosing them to prevent gaps
- trimming and removing dead plants or leaf litter

- pruning climbing vegetation (such as vines) on a trellis, to ensure it does not connect to a building, particularly near windows and doors
- removing vegetation in close proximity to a water tank to ensure it is not touching the sides of a tank
- following the requirements of the relevant local government section 33 fire break notice, which may include additional provisions such as locating wood piles more than 10 metres from a building.

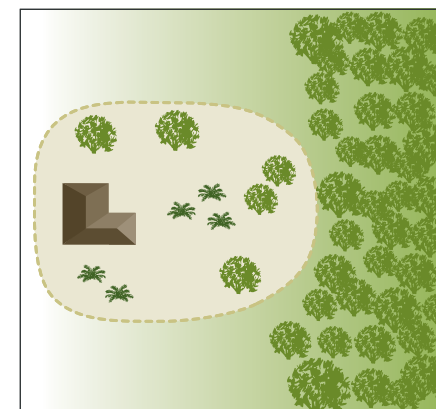
Preparation of a property prior to the bushfire season and/or in anticipation of a bushfire is beneficial even if your plan is to evacuate. Embers can travel up to several kilometres from a bushfire and fall into small spaces and crevices or land against the external walls of a building. Best practice recommends objects within the APZ are moved away from the building prior to any bushfire event. Objects may include, but are not limited to:

- door mats
- outdoor furniture
- potted plants
- shade sails or umbrellas
- plastic garbage bins
- firewood stacks
- flammable sculptures
- playground equipment and children's toys.

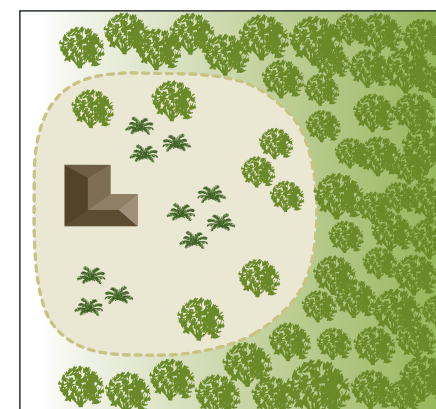
Regardless of whether an Asset Protection Zone exists in accordance with the acceptable solutions and is appropriately maintained, it should be noted that fire fighters are not obliged to protect an asset if they think the separation distance between the dwelling and vegetation is unsafe.

Figure 9: Design of an Asset Protection Zone

Hazard on one side



Hazard on three sides



Legend

- APZ
- trees
- shrubs



A.2.2 PLANT FLAMMABILITY

There are certain plant characteristics that are known to influence flammability, such as moisture or oil content and the presence and type of bark. Plants with lower flammability properties may still burn during a bushfire event but may be more resistant to burning and some may regenerate faster post-bushfire.

There are many terms for plant flammability, which should not be confused, including:

- **Fire resistant** – plant species that survive being burnt and will regrow after a bushfire and, therefore, may be highly flammable and inappropriate for a garden in areas of high bushfire risk.
- **Fire retardant** – plants that may not burn readily or may slow the passage of a bushfire.
- **Fire wise** – plants that have been identified and selected based on their flammability properties and linked to maintenance advice and planting location within a garden.

Although not a requirement of the Guidelines, local governments may develop their own list of fire wise or fire retardant plant species that suit the environmental characteristics of an area. When developing a recommended plant species list, local governments should consult with ecologists, land care officers or environmental authorities to ensure the plants do not present a risk to endangered ecological communities, threatened or endangered species or their habitat.

When selecting plants, private landholders and developers should aim for plants within the APZ that have the following characteristics:

- grow in a predicted structure, shape and height
- are open and loose branching with leaves that are thinly spread
- have a coarse texture and low surface-area-to-volume ratio
- will not drop large amounts of leaves or limbs that require regular maintenance
- have wide, flat and thick or succulent leaves
- trees that have bark attached tightly to their trunk or have smooth bark
- have low amounts of oils, waxes and resins (which will often have a strong scent when crushed)
- do not produce or hold large amounts of fine dead material in their crowns
- will not become a weed in the area.

Refer to the WAPC [Bushfire and Vegetation Fact Sheet](#) for further information on clearing and vegetation management and APZ landscaping, design and plant selection reference material.



A.3 VEHICULAR ACCESS

Table 4: Vehicular access technical requirements

	1		2		3		4		5	
TECHNICAL REQUIREMENTS	PERIMETER ROADS		PUBLIC ROADS		EMERGENCY ACCESS WAY ³		FIRE SERVICE ACCESS ROUTE ³		BATTLE-AXE & PRIVATE DRIVEWAYS ¹	
MAP OF BUSH FIRE PRONE AREAS DESIGNATION	Area 2	Area 1	Area 2	Area 1	Area 2	Area 1	Area 2	Area 1	Area 2	Area 1
Minimum horizontal clearance (metres)	12	8	See note 5		10	6	10	6	6	
Minimum vertical clearance (metres)	4.5									
Minimum weight capacity (tonnes)	15									
Maximum grade unsealed road ²	See note 5		See note 5		1:10 (10% or 6°)					
Maximum grade sealed road ^{2,4}					1:7 (14.3% or 8°)					
Maximum average grade sealed road					1:10 (10% or 6°)					
Minimum inner radius of road curves (metres)					8.5					

Notes:

- ¹ Driveways and battle-axe legs to comply with the Residential Design Codes and Development Control Policy 2.2 Residential Subdivision where not required to comply with the widths in this Appendix or the Guidelines.
- ² Dips must have no more than a 1 in 8 (12.5% - 7.1 degrees) entry and exit angle.
- ³ To have crossfalls between 3 per cent and 6 per cent.
- ⁴ For sealed roads only the maximum grade of no more than 1 in 5 (20 per cent) (11.3 degrees) for no more than 50 metres is permissible, except for short constrictions to 3.5 metres for no more than 30 metres in length where an obstruction cannot be reasonably avoided or removed.
- ⁵ As outlined in the Institute of [Public Works Engineering Australasia \(IPWEA\) subdivision guidelines](#), [Liveable Neighbourhoods](#), [Austroads Standards](#) and/or any applicable standard in the local government area.



EXPLANATORY NOTES

SPP outcome: Ensure the design and capacity of vehicular access and egress provide for efficient and effective evacuation to a suitable destination(s).

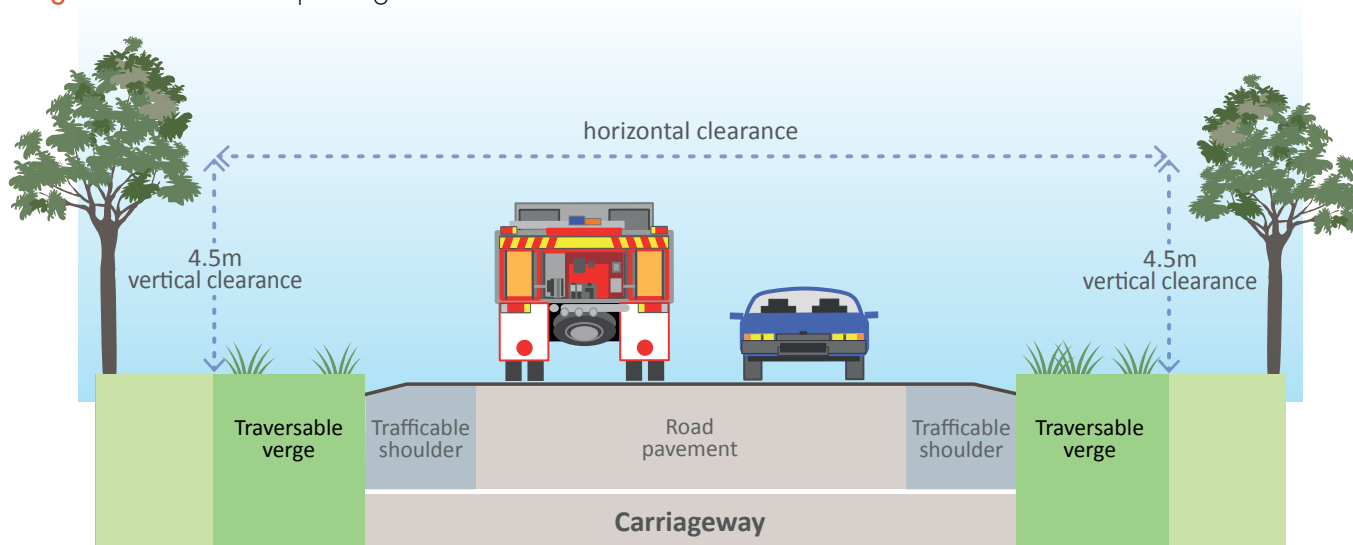
A.3.1 PUBLIC ROADS

The Guidelines do not prescribe values for the trafficable (carriageway/pavement) width or the horizontal clearance of public roads (except for perimeter roads) as they should be in accordance with the class of road as specified in the Public Works Engineering Australasia (IPWEA) subdivision guidelines, Liveable Neighbourhoods, Austroads Standards and/or any applicable standard in the local government area.

However, it is important that public roads (and other forms of access) allow for emergency services vehicles to stop and operate on the side of the public road, specifically where the public road may traverse large areas of classified vegetation. It is, therefore, recommended that public roads achieve a minimum 6 metres horizontal clearance. Perimeter roads require additional width.

Where local government roads are proposed to be widened by the proponent, written approval is required from the local government.

Figure 9: Area encompassing horizontal clearance and vertical clearance



Horizontal clearance: The trafficable and traversable surface that provides for the movement and parking of vehicles and area required by emergency services to operate. It includes the unsealed/sealed road pavement, trafficable shoulders and traversable verges. The traversable verges should be frangible and allow for vehicular movement in the event of an emergency.

A.3.2 ACCESS TO SUITABLE DESTINATION(S)

Public vehicular access in at least two different directions to at least two different suitable destinations should always be the goal within bushfire prone areas. The more options available for evacuation and for emergency services to respond to the bushfire, the better the bushfire resilience of a development and/or a community.

Suitable destination: An area that is not designated as bushfire prone on the Map of Bush Fire Prone Areas or is greater than 100 metres from classified vegetation or 50 metres from Class C Grassland, as per AS 3959, and can provide protection during and after a bushfire event.



A suitable destination is likely to be an urban area, townsite or similar. This also includes any evacuation centre, dedicated by the local government, for use during a bushfire event.

Where a planning proposal, such as a structure plan or subdivision, proposes a large number of lots, or where the structure plan or subdivision adjoins an urban area or townsite, this could potentially result in land that is more than 100 metres from classified vegetation (BAL-LOW). In this instance, an argument could be made that the suitable destination is within the subject site or within the adjoining urban area or townsite. For example, where coastal communities are limited to one public road servicing the community, there may be an existing managed area large enough to provide an area suitable for people to locate to before, during and after a bushfire event.

There is no prescribed distance to a suitable destination as it is assumed that in the event of a bushfire, a person would travel any necessary distance to evacuate.

A suitable destination should not be confused with an on-site shelter provided for tourism land uses. On-site shelters are a last resort option, purpose built or designed, and are supported in limited circumstances to facilitate tourism within remote and/or heavily vegetated areas. On-site shelters are used only where it is demonstrated in a BMP and bushfire emergency plan that in instances when it is no longer safe to evacuate, there is a second and last resort option for visitors and staff to shelter on-site. Early evacuation should always be prioritised.

On-site shelters are not supported for residential land-uses.

Figure 11: Example of compliant and non-compliant two-way access



A.3.3 NO-THROUGH ROADS

No-through roads reduce the legibility of a road network and options available for access and egress in the event of a bushfire emergency. The inclusion of new no-through roads within subdivision or structure plan designs, in the first instance, should be avoided in bushfire prone areas.

However, where it is demonstrated, to the satisfaction of the decision-maker, that a no-through road cannot be avoided due to site or design constraints, the inclusion of a new no-through road is to be treated as an acceptable solution, if it satisfies the prescribed maximum road length. Where this is not demonstrated, a decision-maker is able to request a redesign to remove the no-through road.

The acceptable solution for no-through roads in areas designated as Area 2 on the *Map of Bush Fire Prone Areas* includes a maximum of 200 metres from the lot(s) boundary to an intersection where two-way access is provided. There is no prescribed maximum length for no-through roads in areas designated as Area 1 on the *Map of Bush Fire Prone Areas*.

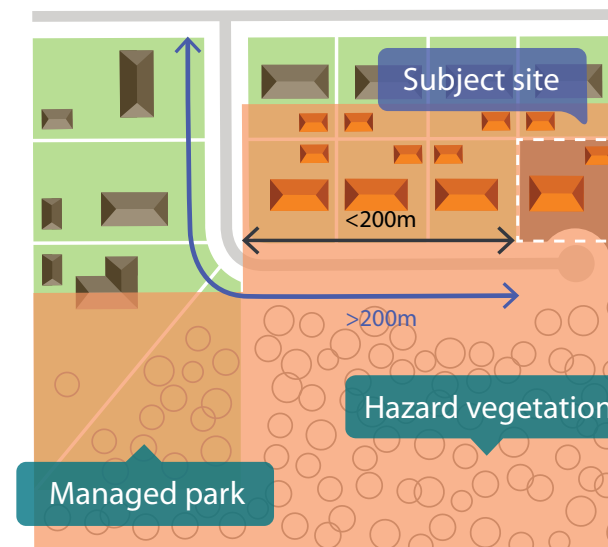
It becomes more challenging to comply with the acceptable solutions where the proposal includes existing no-through roads that exceed 200 metres. Support for development on existing no-through roads longer than the prescribed 200 metres should be considered carefully. They should be the exception to the rule where it is demonstrated through an outcomes-based approach that the hazards and the road network within the broader landscape are such that, in the event of a bushfire, evacuation to a suitable destination is possible.



Figure 12: Demonstration of a lot achieving two-way access within 200 metres



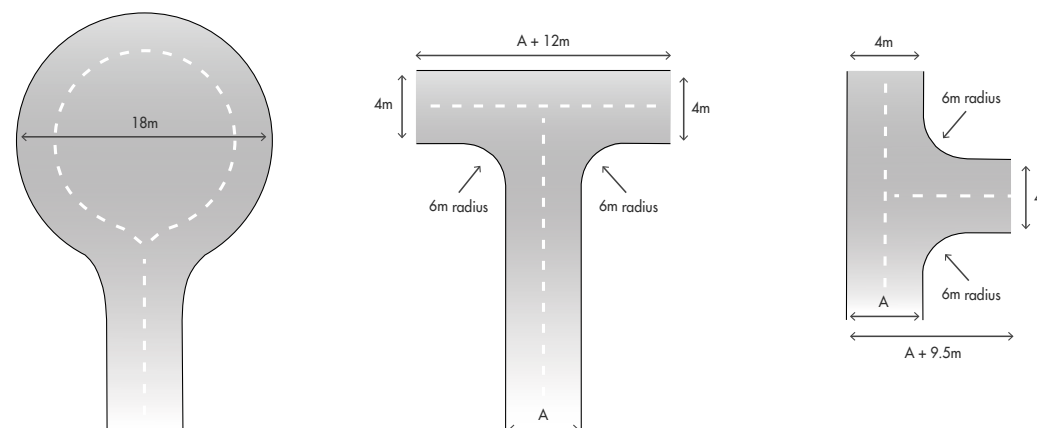
Figure 13: Example of a site on a no-through road greater than 200 metres but within 200 metres of BAL-LOW



An outcomes-based approach should justify the increase in length, and/or the proposed additional lots, on an existing non-compliant no-through road and should consider:

- the broader landscape
- size and scale of the development
- whether the no-through road travels away from the source of the bushfire hazard (Figure 13)
- evacuation in the event of a worst-case bushfire scenario
- the vegetation within and adjoining the road reserve

Figure 14: Design requirements for a turn-around area for a no-through road





- legibility of the broader road network
- whether the no-through road is straight and provides a line of sight
- any improvements to the bushfire resilience of the existing landowners/occupiers in the area, including improvements to the existing road or vegetation modification.

A.3.4 EMERGENCY ACCESS WAY

An emergency access way is not a preferred alternative to public road access. It should be considered acceptable only where it has been demonstrated that public road access cannot be achieved due to site or environmental constraints and that it will provide for the safety and performance needs of emergency services and the community.

The principal function of the emergency access way is to provide a contingency (second) public evacuation route and simultaneously provide access for emergency services in the event of a bushfire. Where an emergency access way traverses classified vegetation, it performs the secondary function of providing access for emergency services to this vegetation.

Emergency accessways should connect to a public road. An emergency accessway should not exceed 500 metres in length as there are often issues of legibility and safety. Emergency accessways are generally not part of the formal road network and many are not identified on various online or other mapping platforms, which may limit emergency services and/or the community finding their way through the network in an emergency.

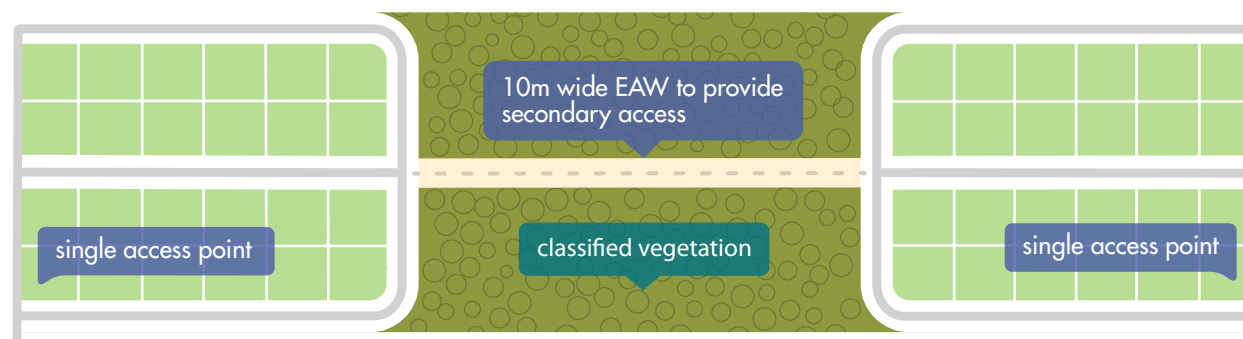
Where the emergency access way is located within an area designated as Area 2 on the *Map of Bush Fire Prone Areas*, a minimum horizontal clearance of 10 metres should be provided. The 10 metres is to provide access for emergency services to any classified vegetation, including grassland, adjoining the easement. Where there are areas along the easement with no classified vegetation,

the width may be reduced where an outcomes-based approach in accordance with policy measure 7.4 of SPP 3.7 is used. A minimum six metres horizontal clearance should be provided within an area designated as Area 1 on the *Map of Bush Fire Prone Areas*.

Figure 15: Example of a 9 metre wide emergency access way



Figure 16: Example of a 10 metre wide emergency access way





A.3.4.1 Permanent public emergency access way

A public emergency access way can be provided as either a public easement in gross or a right-of-way. In both approaches, the care, control and management of the emergency access way should be the responsibility of the local government as the grantee of the easement or management body of the right-of-way (ceded to the Crown).

If the emergency access way is provided as an easement, it should be provided as a public easement in gross under sections 195 and 196 of the *Land Administration Act 1997* in favour of the local government and/or public authority, to ensure accessibility by fire emergency services and the public at all times. If the emergency access way traverses an adjoining private lot(s), support will be necessary from the adjoining lot owner(s).

To be provided as a right-of-way, the emergency access way should be vested as such in the Crown under section 152 of the *Planning and Development Act 2005*. Such land should be ceded free of cost and without any payment or compensation by the Crown.

The proponent should obtain written consent from the local government that it will accept care, control and management of the easement or right-of-way. This should be provided to the decision-maker prior to granting planning approval. Consultation with Land Use Management Division of the Department of Planning, Lands and Heritage should also be undertaken if the land is to be ceded to the Crown.

If gates are used to control traffic flow during non-emergency periods, these will be managed by the local government and should not be locked. They should be double gates wide enough to access the whole trafficable

width and accommodate type 3.4 fire appliances with the design and construction to be approved by the relevant local government.

A.3.4.2 Right-of-carriageway emergency access way

There may be instances where a proposed development is limited to secondary access through the adjoining lot(s). A right-of-carriageway easement can be provided under

section 195 of the *Land Administration Act 1997*, which restricts the use of the emergency access way to the lot owner(s) and emergency services and is not available to the public.

Written support is required from the adjoining lot owner(s). Approval for the use of these types of right-of-carriageway is on a case-by-case basis and at the discretion of the decision-maker. The easement is to be granted to the

Figure 17: Example of where an emergency access way may be provided

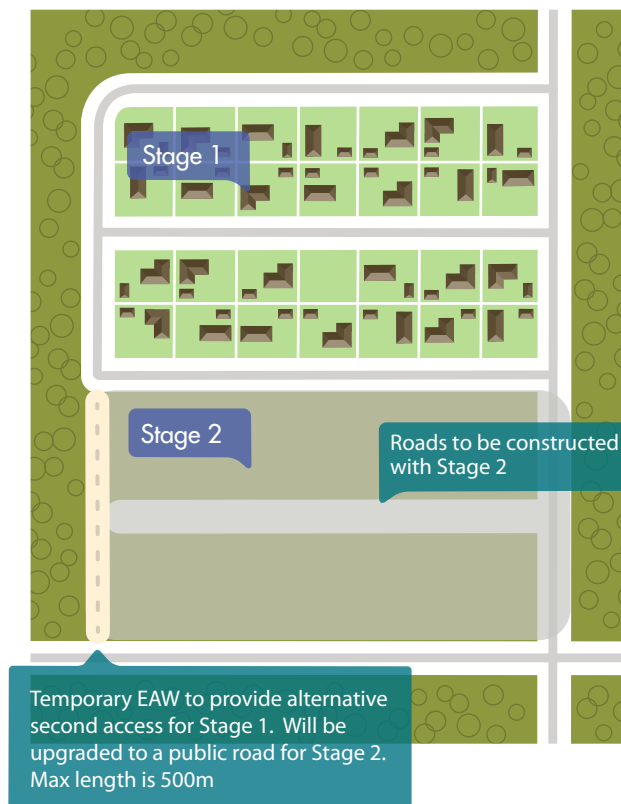


Figure 18: Example of a 6 metre wide emergency access way





local government and its management should be agreed to by all parties and included within the deed. If gated, the easement area can be locked to restrict day-to-day vehicular access.

A.3.4.3 Temporary emergency access way

A temporary emergency access way may be proposed to facilitate the staging arrangements of a subdivision. The provision of two public roads may not be possible or feasible in the first stage of the subdivision and an emergency access way can be provided as an interim access route, until the second public road is constructed in the subsequent stage of the subdivision (Figure 17).

A.3.4.4 Restricted public emergency access way

Emergency access ways should not be gated, or where they are gated should not be locked. However, there may be instances where the local government or Main Roads Western Australia will request that the gate be locked and public vehicular access restricted, except during an emergency. This is usually due to concern regarding the additional vehicular movements onto an existing local or state road.

In this scenario, the emergency access way can be provided as an easement under section 195 of the *Land Administration Act 1997*, as public access in the event of a bushfire emergency, or vested in the Crown as a reserve under section 152 of the *Planning and Development Act 2005*. Where vested, such land is to be ceded free of cost without any payment or compensation by the Crown. The proponent should obtain written consent from the local government accepting care, control and management of the proposed easement or reserve and

agree to the terms of the Management Order Conditions (if applicable); this should be provided to the decision-maker prior to granting planning approval.

The reserve should be for a public purpose specified in the condition related to the subdivision, for example, for emergency access only or for emergency access and recreation. A reserve for emergency access and recreation optimises the land-use by providing vehicular access in the event of a bushfire emergency and daily access by the public (on foot) as a recreation link. Appropriate signage can ensure the public is aware of the purpose of the reserve.

A.3.5 PERIMETER ROADS

Hazard separation should be provided in the form of a perimeter road where a strategic planning proposal or subdivision application includes the creation of 10 or more lots adjacent to each other, which adjoin classified vegetation under AS 3959 with the exception of Class G Grassland, as part of a greenfield development or large urban infill site.

The creation of 10 or more lots includes cumulative subdivision applications where the subdivision application may be part of a staged subdivision.

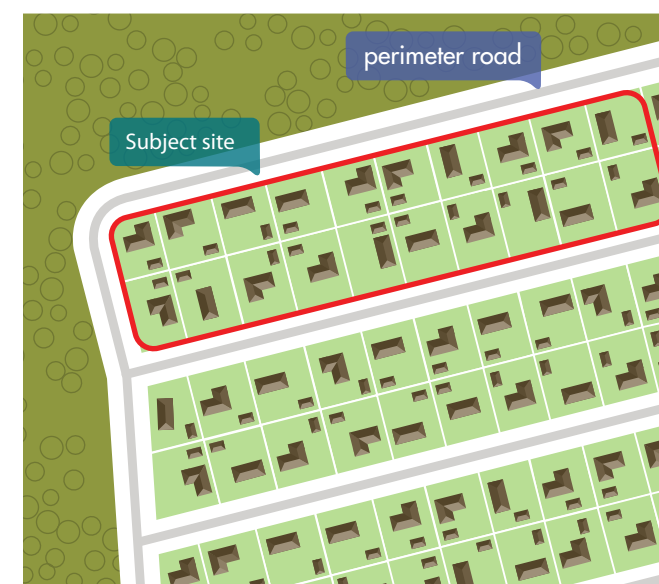
As the road is likely to function as a key neighbourhood distributor or similar, it is important to provide additional width to allow emergency services vehicles to stop and operate on the side of the perimeter road, whilst simultaneously providing for community evacuation. This is reflected in Table 4, Column 1 requirements.

When designing a strategic planning proposal and/or subdivision, there are many benefits in creating a large setback between classified vegetation and proposed lots

with a perimeter road and orientating habitable buildings to front rather than back onto areas of vegetation. They include:

- passive surveillance
- defensible space for firefighting and emergency management purposes
- reducing the potential radiant heat that may impact a habitable building in a bushfire event
- reducing the need for battle-axe lots
- unconstrained public access/egress for the community in the event of a bushfire.

Figure 19: Example of a perimeter road





In developments where no perimeter road exists, property defence in a bushfire event is difficult and can be impossible. Where proposed lots have frontage to an existing public road and abut the hazard at the rear or side, it may be an undesirable planning outcome to create lots that front the existing public road and back onto a perimeter road. In this instance, consideration should be given to a fire service access route.

A.3.6 FIRE SERVICE ACCESS ROUTE

Where a planning proposal adjoins classified vegetation (excluding Class G Grassland) and where a perimeter road is not appropriate and/or not required, there may be a need to provide access for emergency services vehicles to classified vegetation for firefighting and fire management purposes.

This route is not intended to provide residents and the public with emergency egress and, therefore, is not a suitable second access or substitute for a public road.

Where the fire service access route is within an area designated as Area 2 on the *Map of Bush Fire Prone Areas*, a minimum horizontal clearance of 10 metres should be provided to allow access for emergency services to any classified vegetation adjoining the fire service access route. In areas along the fire service access route with no classified vegetation, the width may be considered for reduction where an outcomes-based approach is used. A minimum six metres horizontal clearance should be provided where the area is designated as Area 1 on the *Map of Bush Fire Prone Areas*.

A fire service access route can be provided as either an easement in gross over private or Crown land or ceded to the Crown as a reserve. In both approaches, the

management of the fire service access route is by the local government as the grantee of the easement or management body of the reserve. Determining which approach to take depends on the intended tenure of the fire service access route, which is explained below. The proponent should obtain written consent from the local government that it will accept care, control and management of the easement or reserve and agree to the terms of the Management Order Conditions (if applicable). This should be provided to the decision-maker prior to granting planning approval. The approach taken is at the discretion of the decision-maker and/or the local government. Consultation with Land Use Management Division of the Department of Planning, Lands and Heritage should also be considered if the land is to be ceded to the Crown or if the local government is uncertain of which approach to take.

Where gates are used, they should be double gates wide enough when open to allow vehicles to access the whole trafficable width and accommodate type 3.4 fire appliances. The design and construction are to be approved by the relevant local government. Gates on fire service access routes may be locked to restrict access provided a common key system is used. Keys are to be available to emergency services and designated fire officers within the local government area and/or surrounding district. Gates should be installed where fences intersect or cross over with fire service access routes. If an easement in gross is proposed, such arrangements for gates should be included in the deed of easement and be agreed to by the local government.

A.3.6.1 Fire service access route to remain in private ownership of multiple landowners

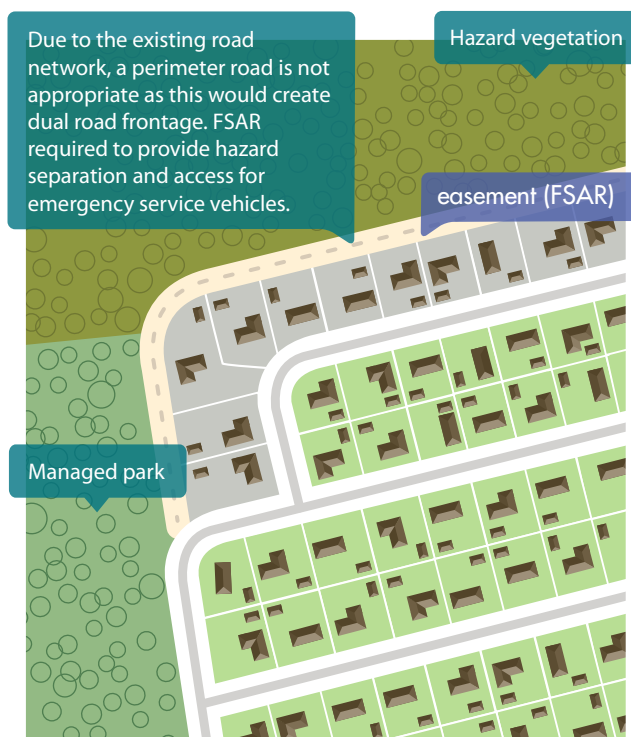
Where a fire service access route is proposed to traverse multiple private lots and they are intended to remain in the private ownership of the multiple landowners, it should be provided as an easement in gross under section 195 of the *Land Administration Act 1997*, to ensure accessibility for fire emergency services and not for use by the public. The easement is to be granted to the local government and/or public authority for firefighting and emergency management purposes.

A.3.6.2 Fire service access route to be created under State ownership

Where a fire service access route is proposed to traverse multiple private lots but the decision-maker and/or local government prefer for it in a single parcel for management purposes, the route can be vested in the Crown under section 152 of the *Planning and Development Act 2005* as a reserve. Such land is to be ceded free of cost without any payment or compensation by the Crown. The reserve should be for a public purpose specified in the condition related to the subdivision, for example, for vehicular access for emergency services and the local government only, or for vehicular access for emergency services and the local government and recreation. A reserve for emergency services access and recreation optimises the land-use by providing vehicular access for emergency services and daily access by the public (on foot) as a recreation link. Appropriate signage will ensure the public is aware of the purpose of the reserve. The approach taken is at the discretion of the decision-maker and/or local government.



Figure 20: Example of a fire service access route



- existing development
- new development

A.3.7 BATTLE-AXE ACCESS LEGS

In bushfire prone areas, lots with battle-axe access legs should be avoided because they:

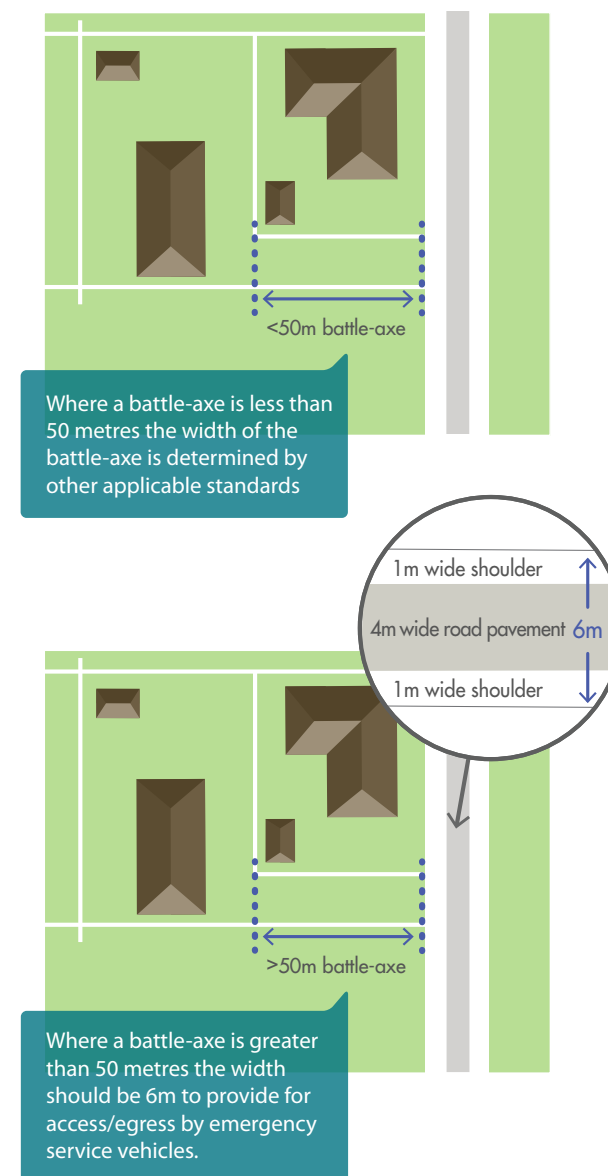
- do not enable the habitable building to be located close to a public road where it is visible to emergency services
- result in longer than necessary access routes for evacuation and the response by emergency services
- may be blocked by falling trees or debris
- may not provide certainty for emergency services regarding the width, length and ability to turn around emergency services vehicles.

In some instances, battle-axe access legs may be appropriate to overcome specific site or design constraints created by the existing road network or lot layout. The BMP should provide justification for proposed battle-axe access leg(s) and the decision-maker should determine whether the justification is valid.

Where the use of battle-axe access legs is considered appropriate, the measurement should be from the edge of the public road to where the access leg joins the effective area of the battle-axe lot. Effective lot area means that part of the battle-axe lot that is capable of development and excludes the access leg and associated truncations for vehicle manoeuvrability.

Turn-around areas should allow type 3.4 fire appliances to turn around safely (for example, kerb to kerb 18 metres) and should be located within 30 metres of the future development site.

Figure 21: Battle-axe design requirements





A.3.8 PRIVATE DRIVEWAYS

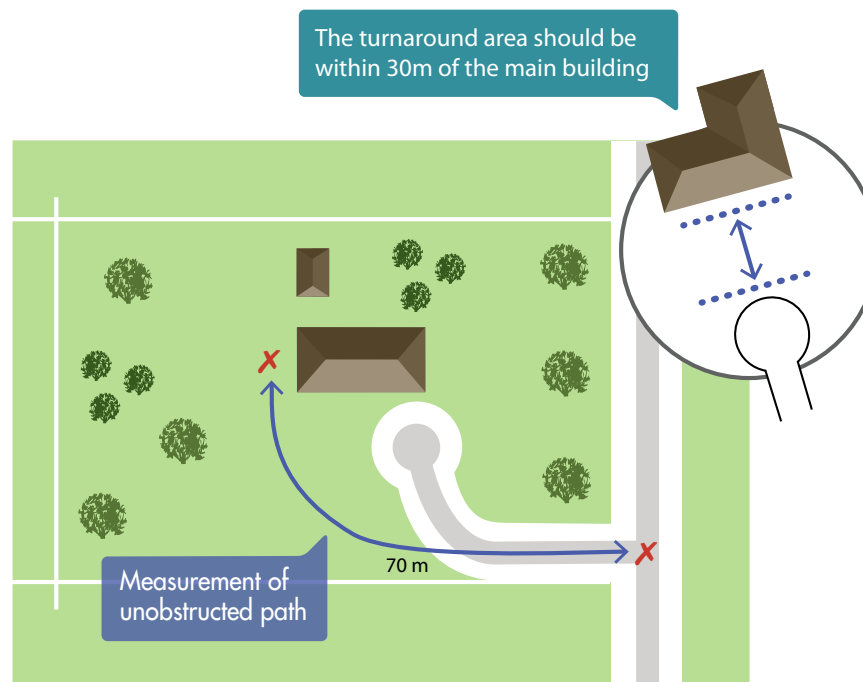
Emergency services vehicles typically operate from the street frontage in areas serviced by reticulated water and where the distance from the public road to the farthest part of the habitable building is no greater than 70 metres.

In the event the habitable building cannot be reached by hose reel from the public road, emergency services vehicles will need to gain access via the driveway to the property. Emergency services vehicles will also need to gain access to the property where access to water is provided by onsite water tanks. In these situations, the driveway and battle-axe access leg (if applicable) will need to be wide enough for access by an emergency services vehicle and a vehicle to evacuate.

It is acceptable for a private driveway to have a carriageway (trafficable) width of four metres with a traversable verge of one metre on either side of the carriageway.

Turn-around areas (Figure 22) should be available for conventional two-wheel drive vehicles and type 3.4 fire appliances and should be located within 30m of habitable buildings. Circular and loop driveway design may also be considered.

Figure 22: Design requirements for a private driveway where required





A.4 WATER SUPPLY

Table 5: Water supply dedicated for bushfire firefighting purposes

SECTIONS FROM THE PLANNING FOR BUSHFIRE GUIDELINES					
SECTION 6 ² STRUCTURE PLANS (LOT LAYOUT/ INTERNAL ROAD NETWORK KNOWN) AND SUBDIVISION APPLICATIONS		SECTION 7 ² DEVELOPMENT - RESIDENTIAL	SECTION 8 DEVELOPMENT - COMMERCIAL, INDUSTRIAL & COMMUNITY	SECTION 9 - TOURISM LAND USES	
1 additional lot	10,000 L water tank per lot	10,000 L water tank per habitable building	For each habitable building - 10,000 L per 1,500 m ² of floor space up to 50,000 L. Provided in a water tank	Short-term accommodation	10,000 L water tank per habitable building
3 to 24 lots	10,000 L water tank per lot ¹ or 50,000 L strategic water tank			Camping ground	At the discretion of the local government
25 lots or more	50,000 L per 25 lots or part thereof, provided as a strategic water tank(s) and/or 10,000 L water tank per lot			Day uses	For each habitable building - 10,000 L per 500 m ² of floor space up to 50,000 L. Provided in a water tank

Notes:

¹ For multiple or grouped dwellings of fewer than five lots, water supply may be provided as one tank for all proposed lots on common property or as one tank per lot. A strategic water tank does not need to be provided.

² Evidence that the identified water supply amounts in either column denoted is to be provided at the relevant planning stage.



EXPLANATORY NOTES

SPP outcome: Ensure that sufficient water is available and accessible for emergency services use, to enable people, property and infrastructure to be defended from bushfire.

A.4.1 CONSTRUCTION AND DESIGN

An above-ground tank and associated stand should be constructed of non-combustible material. The tank may need to comply with AS/NZS 3500.1:2018.

Below-ground tanks should have a 200 millimetres diameter access hole to allow tankers or emergency services vehicles to refill direct from the tank, with the outlet location clearly marked on the surface. The tank may need to comply with AS/NZS 3500.1:2018. An inspection opening may double as the access hole provided that the inspection opening meets the requirements of AS/NZS 3500.1:2018.

Where an outlet for an emergency services vehicle is provided, then an unobstructed, hardened ground surface is to be supplied within four metres of any water supply.

A.4.1.1 Pipes and fittings

All above-ground, exposed water supply pipes and fittings should be metal. Fittings should be located away from the source of bushfire hazard and be in accordance with the applicable section below, unless otherwise specified by the local government.

A.4.1.2 Fittings for above-ground water tanks:

- Commercial land uses: 125 mm Storz fitting; or
- Strategic water tanks: 50 mm or 100 mm (where applicable and adapters are available) male camlock coupling with full flow valve; or
- Standalone water tanks: 50 mm male camlock coupling with full flow valve; or
- Combined water tanks: 50 mm male camlock coupling with full flow valve or a domestic fitting, being a standard household tap that enables an occupant to access the water supply with domestic hoses or buckets for extinguishing minor fires.

A.4.1.3 Remote outlets

In certain circumstances, it may be beneficial to have the outlet located away from the water supply. In instances in which a remote outlet is to be used, the applicant should consult the local government and DFES on their proposal.

A.4.2 USE OF WATER SUPPLY

Water supply for firefighting in the event of a bushfire can be provided on a lot for use by emergency services or for use by the landowner, if their Bushfire Survival Plan is to stay and defend their property. The combination of drinking water and water for firefighting purposes is not recommended, as stagnant water may alter the quality of the drinking water and the emergency services, by law, may not be able to take water from the water supply to suppress a bushfire.

Combining drinking water and water for firefighting purposes is contrary to provisions within clause 4.2.3 of AS/NZS 3500.1:2021.

A.4.3 INDEPENDENT WATER AND POWER SUPPLY

Bushfires can directly impact a water service provider's equipment or pipes. As such, a reticulated water supply may not be reliable due to a reduction in water pressure or loss of supply. Where development is in an area designated as Area 2 on the *Map of Bush Fire Prone Areas* and/or where the local government area has known issues with water supply or pressure, it is recommended that the landowner consider providing a water tank in accordance with Table 5, Water supply dedicated for bushfire firefighting purposes.

In non-reticulated water supply areas, it is recommended that any pumping equipment be powered by means other than the electricity network. The pumping equipment could be a diesel or petrol-powered pump, or an electric pump if there is an onsite generator or backup power supply independent of the electricity network grid.

It is recommended that combustion pumps should be a minimum 5 hp or 3 kW diesel or petrol-powered pump and should be shielded against bushfire attack. Where an electric pump is used, a backup power supply independent of the electricity network grid should be provided. A 3.7 kW/12k W/h sized battery (14.8 kW/h reserved solely for bushfire will power a 3.7 kW system for four hours) with blackout protection or a generator should be provided.

A.4.4 STRATEGIC WATER SUPPLIES

Many local governments have a well-developed network of strategic water tanks for firefighting within their local government area. Given this, it is at the discretion of the local government to determine if the water supply within



a locality is sufficient to cater for an increasing population when a subdivision is proposed. Local governments are encouraged to work with local emergency services to ensure the water supply needs for firefighting are understood.

Where a structure plan or subdivision proposes to create more than three but fewer than 24 lots, it is at the discretion of the local government whether it requires a strategic water tank or for each lot to be provided with a 10,000 litre tank.

A strategic water tank should be located no more than 10 minutes from the farthest development site (20 minute turnaround time). The turnaround time is the time it takes an emergency services vehicle to travel at legal road speeds from a lot to the water supply and back to the lot. Where a strategic water tank has been provided at the subdivision stage, the local government should consider whether the tank has the capacity to serve applications for development approval.

A landowner should enquire with their local government to determine whether a private water tank on their lot will be required.

When there is fragmented ownership of a structure plan area, or when staging of a subdivision is to occur and the local government has determined that a strategic water tank is required, then the first stage should include arrangements for the installation of a strategic water tank and the identification of land to be ceded. This should occur free of cost, without any payment or compensation by the Crown, as a Crown reserve for 'strategic water supply for firefighting purposes' (if applicable). Where local planning scheme provisions provide for developer contributions for public infrastructure and

the local government is supportive, then a cash-in-lieu arrangement may be established for the provision of a strategic water tank.

A.4.5 LOCATION OF WATER TANKS AND HYDRANTS

Surrounding vegetation should be considered when locating a water tank. Avoid locations where the tank will be situated underneath existing vegetation or where vegetation will grow against or overhang the tank, (Figure 23). Where a tank is on the bushfire hazard side of a building, sufficient shielding for the protection of firefighters should be provided. In addition to the tank location, the fitting should be positioned and/or shielded from the bushfire hazard to allow access by emergency services.

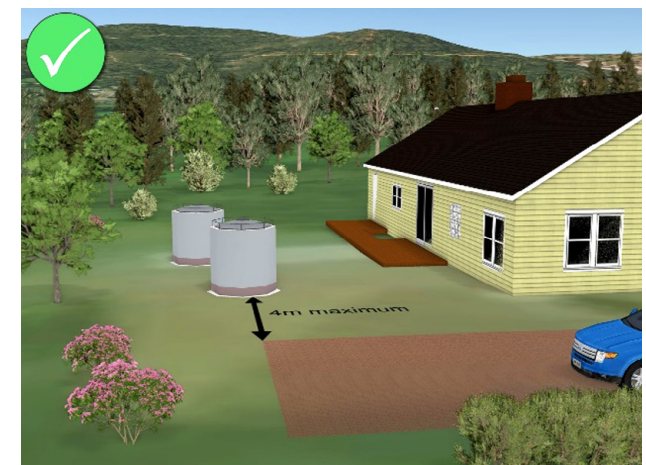
In areas serviced by reticulated water, where the distance from the public road to the farthest part of the habitable building is greater than 70 metres, emergency services vehicles will need to gain access within the property and be provided with a water supply for firefighting purposes. This is because access to reticulated water (fire hydrants) is not possible further than 70 metres, due to the length of the hose reel.

A.4.6 ALTERNATIVE WATER SOURCES

A dam, river or other source may be considered a firefighting water source for emergency services if it complies with DFES guidelines, and it can be demonstrated that the water level will be maintained above the top of the highest fire brigade suction point.

Approval for the use of these types of water supplies is on a case-by-case basis and at the discretion of the decision-maker, in consultation with emergency services and local government.

Figure 23: A good and bad example of landscaping around a water tank





BUSHFIRE ASSESSMENT METHODOLOGIES

APPENDIX B.1 – BROADER LANDSCAPE ASSESSMENT (BLA) METHODOLOGY

B.1.1 WHAT IS A BLA

The BLA examines the area external to the strategic planning proposal, subdivision or development application extending beyond the 150 metres Bushfire Hazard Level (BHL) or BAL Contour Map assessment area and includes an assessment of the bushfire hazards (vegetation extent and slope), the broader road network, proximity to urban areas and suitable destinations for evacuation.

B.1.2 WHEN SHOULD A BLA BE USED

Strategic planning proposals, subdivision and development applications within an area designated as Area 1 on the *Map of Bush Fire Prone Areas* will not require an assessment of the broader landscape or need to demonstrate compliance with Element 1: location.

Where the following strategic planning proposals, subdivision and development applications are located within an area designated as Area 2 on the *Map of Bush Fire Prone Areas*, they require an assessment of the broader landscape to demonstrate compliance with Element 1: location.

- a. All strategic planning proposals (Section 5)
- b. All structure plans and subdivisions (Section 6)
- c. Vulnerable (commercial/industrial) development applications (Section 8)
- d. Vulnerable tourism land uses where an outcomes-based approach is triggered (Section 9).

B.1.2.1 How to consider previous BLAs

Where a strategic planning proposal, subdivision or development application was assessed against SPP 3.7 (2015) and the Guidelines, the subsequent stage(s) of the planning process, or modification or addition to the development approval should demonstrate compliance with SPP 3.7 (2023) and the Guidelines, including a BLA to satisfy Element 1: location (if required).

Where a BLA has been undertaken at a prior planning stage, the assessment may still be relevant for use at a subsequent planning stage(s).

Notwithstanding this, the decision-maker may request a new BLA if they believe that the existing assessment is inappropriate or inadequate. This may include, but not be limited to, instances where there has been a significant period of time since the original assessment was completed/approved, the planning proposal is significantly different, the broader landscape conditions have changed or the original BLA contains sufficient errors to render the assessment unreliable.

B.1.3 WHO CAN CONDUCT A BLA

It is strongly recommended where a BLA is required, the assessment and the BMP should be prepared by an accredited Level 2 or Level 3 bushfire planning practitioner.

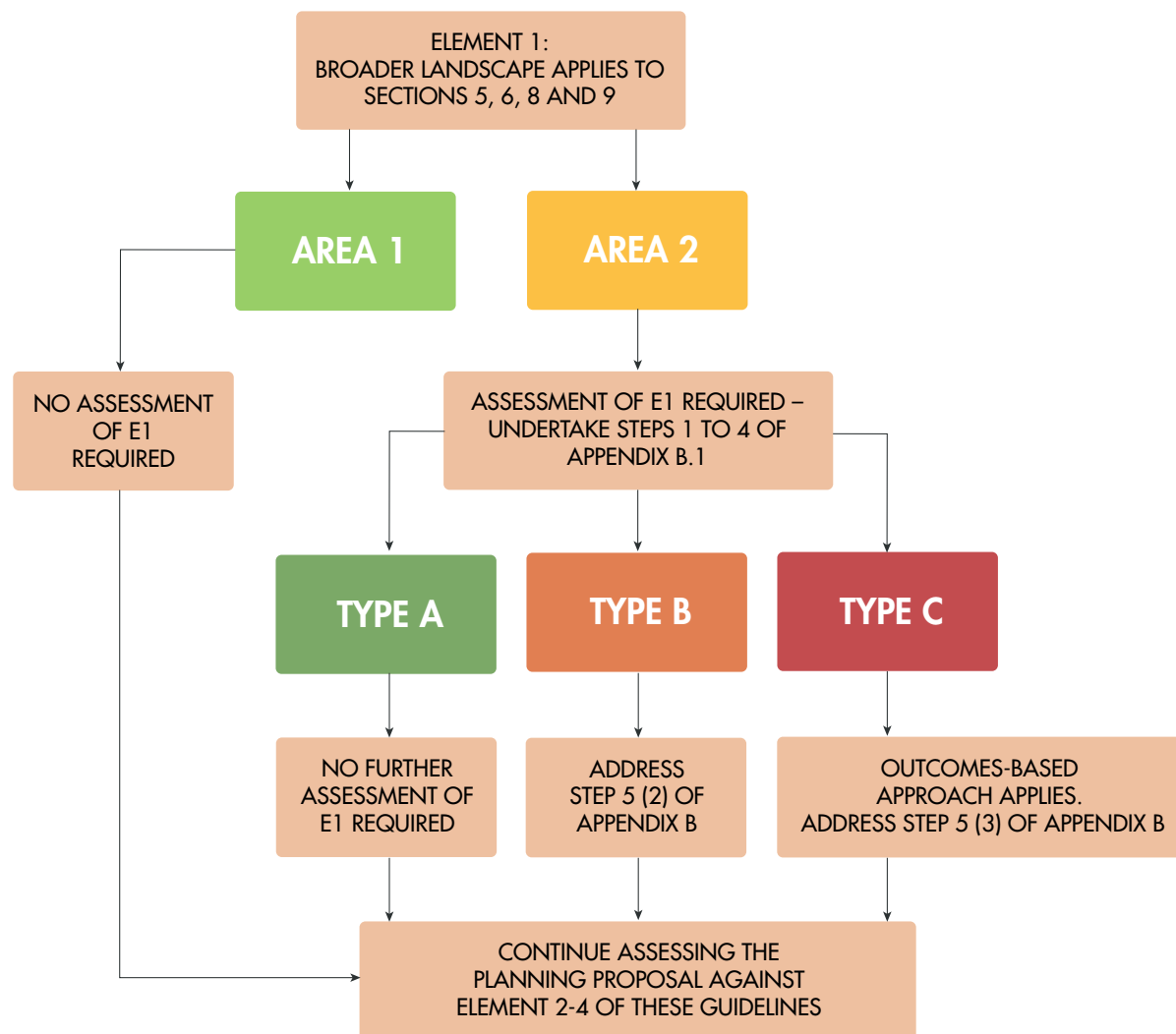
Where the BLA determines that the broader landscape is a type C, then an outcomes-based approach is required. It is strongly recommended that this be undertaken by an accredited Level 3 bushfire planning practitioner.

B.1.4 BLA METHODOLOGY

A BLA should be prepared in accordance with this Appendix. Compliance with Element 1: location is provided in Section 4 – Higher order strategic planning documents and Section 5 – Strategic planning proposals. Where an outcomes-based approach is required, additional guidance is provided in Appendix A.1: location.



Figure 24: Assessment process for Element 1



Step One: Assess the internal hazard

A BHL or BAL Contour Map assessment is required to be prepared in accordance with Appendix B.2 and Appendix B.3 of the Guidelines.

Step Two: Determine the BLA area

The assessment area should include the area at least two kilometres beyond the 150 metres BHL or BAL Contour Map assessment area (Figure 25).

Where multiple development sites are proposed, the practitioner may decide that the assessment area is better represented by grouping the development sites into one area (Figure 26).

The practitioner may recommend and/or the decision-maker may determine that a larger BLA area should be used. This may be due to one or more of the following:

- the extent of contiguous vegetation
- proximity to a suitable destination
- the point of two-way access is beyond the two kilometre assessment area
- the vulnerability of future occupants or visitors.

This information can be agreed on at a pre-lodgement meeting with the decision-maker prior to undertaking the BLA.



Figure 25: How to determine the Broader Landscape Assessment area

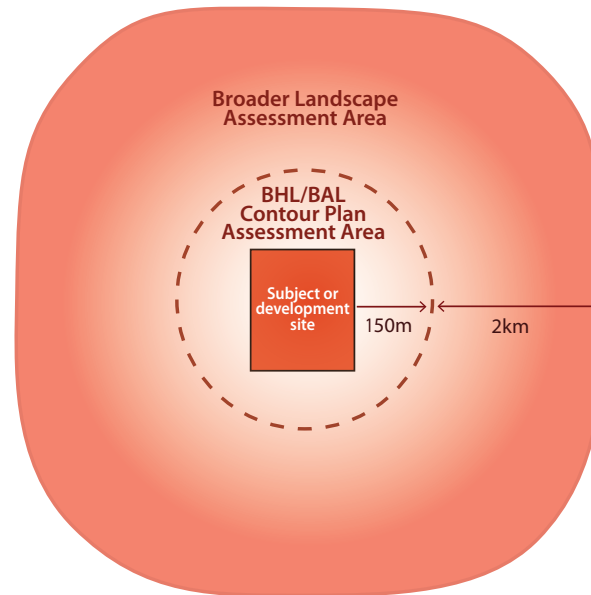
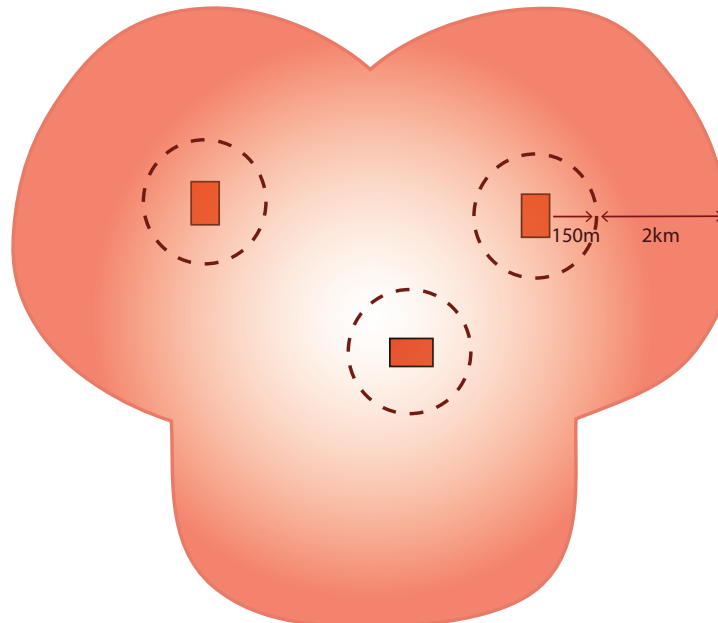


Figure 26: Broader Landscape Assessment area for multiple development sites





Step Three: Assess and map the broader landscape

Relevant information for the BLA should be shown and annotated on a scaled aerial map. The map should be supported by explanatory text commensurate with the scale and complexity of the proposal and/or the broader landscape. The bushfire hazards within the BLA area include contiguous classified vegetation and the underlying slope that are likely to present a bushfire threat to the planning proposal.

A Assess and map vegetation

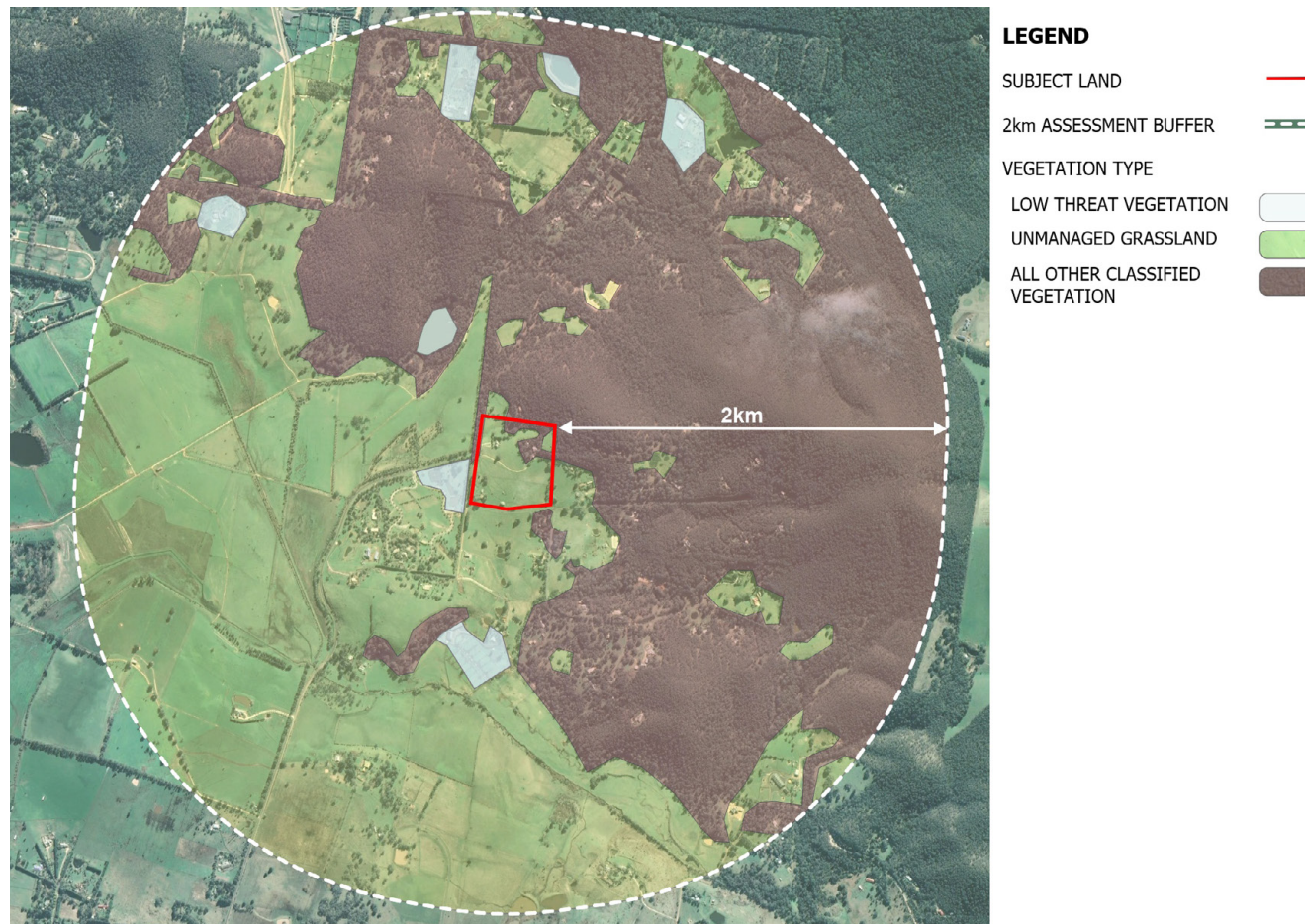
Using up-to-date aerial imagery, undertake a desktop vegetation assessment by delineating plots on the aerial image that distinguish between:

- areas of low threat vegetation and non-vegetated areas (refer to exclusions under AS 3959)
- areas of unmanaged grassland
- areas of all other types of classified vegetation (as one category).

Where the planning proposal adjoins land with an approved structure plan or subdivision, which has been assessed under SPP 3.7 (2015 or 2023) and proposes a post-development BAL rating of BAL-LOW, but is yet to be developed, this can be treated as a future non-vegetated area, as it should not present a future external bushfire hazard.

Where the BLA area includes or directly abuts a coastline or water body, then this area should be considered as a non-vegetated area.

Figure 27: Example of Vegetation type and whether it is continuous or fragmented



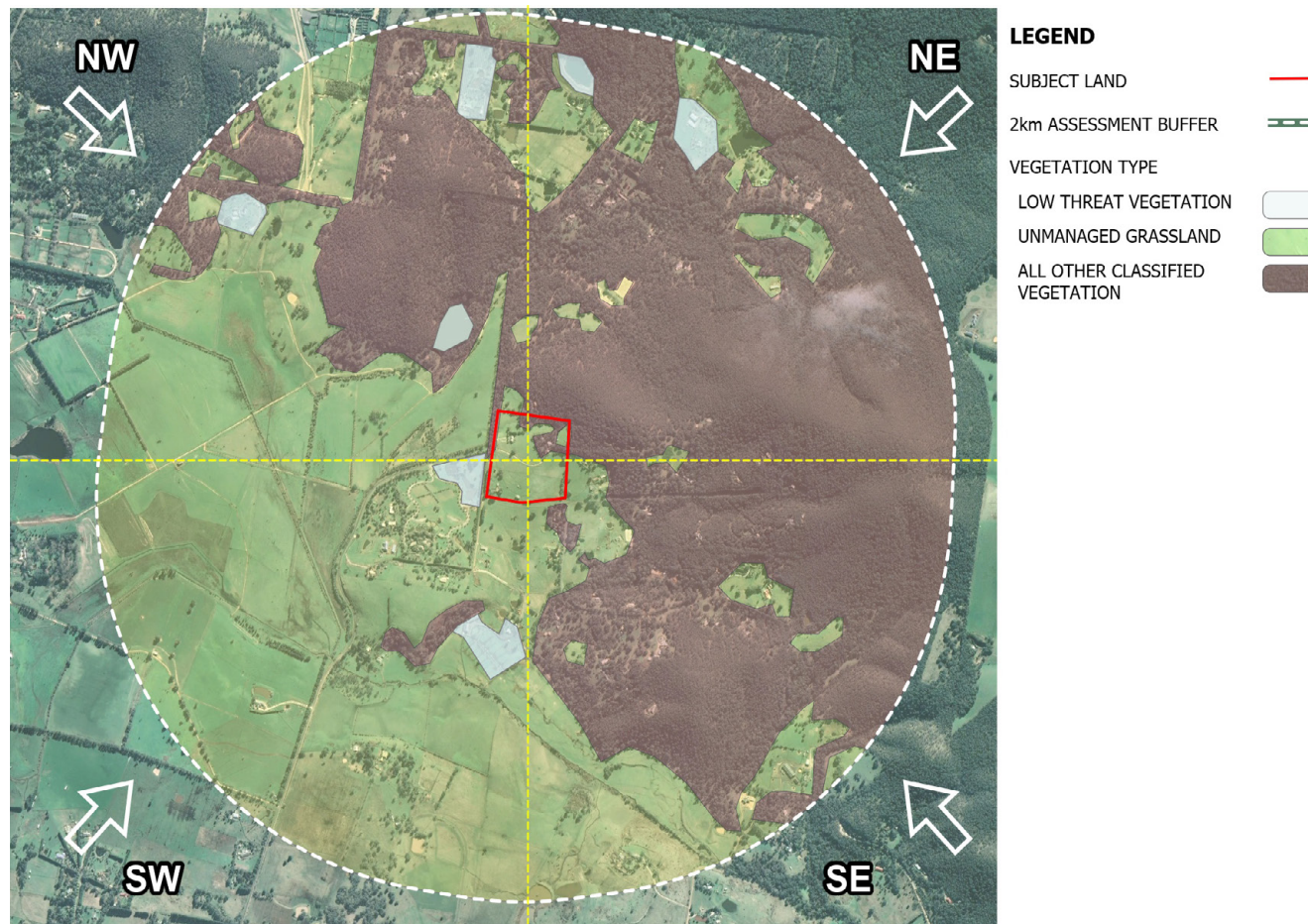


B Assess and map aspects

An assessment of aspects is used to quantify the bushfire hazards that exist within the BLA area that are likely to present landscape-scale destruction, including significant house loss and potential loss of life.

Assume that there are four aspects to the planning proposal, irrespective of the proposal shape and confirm whether they are cardinal directions (North, South, East, or West) or intercardinal directions (Northeast, Southeast, Northwest and Southwest). The extent of classified vegetation should be considered in relation to the identified aspects. Where the BLA area includes or directly abuts a coastline or water body, then this is to be counted as an aspect.

Figure 28: Example of Aspect assessment





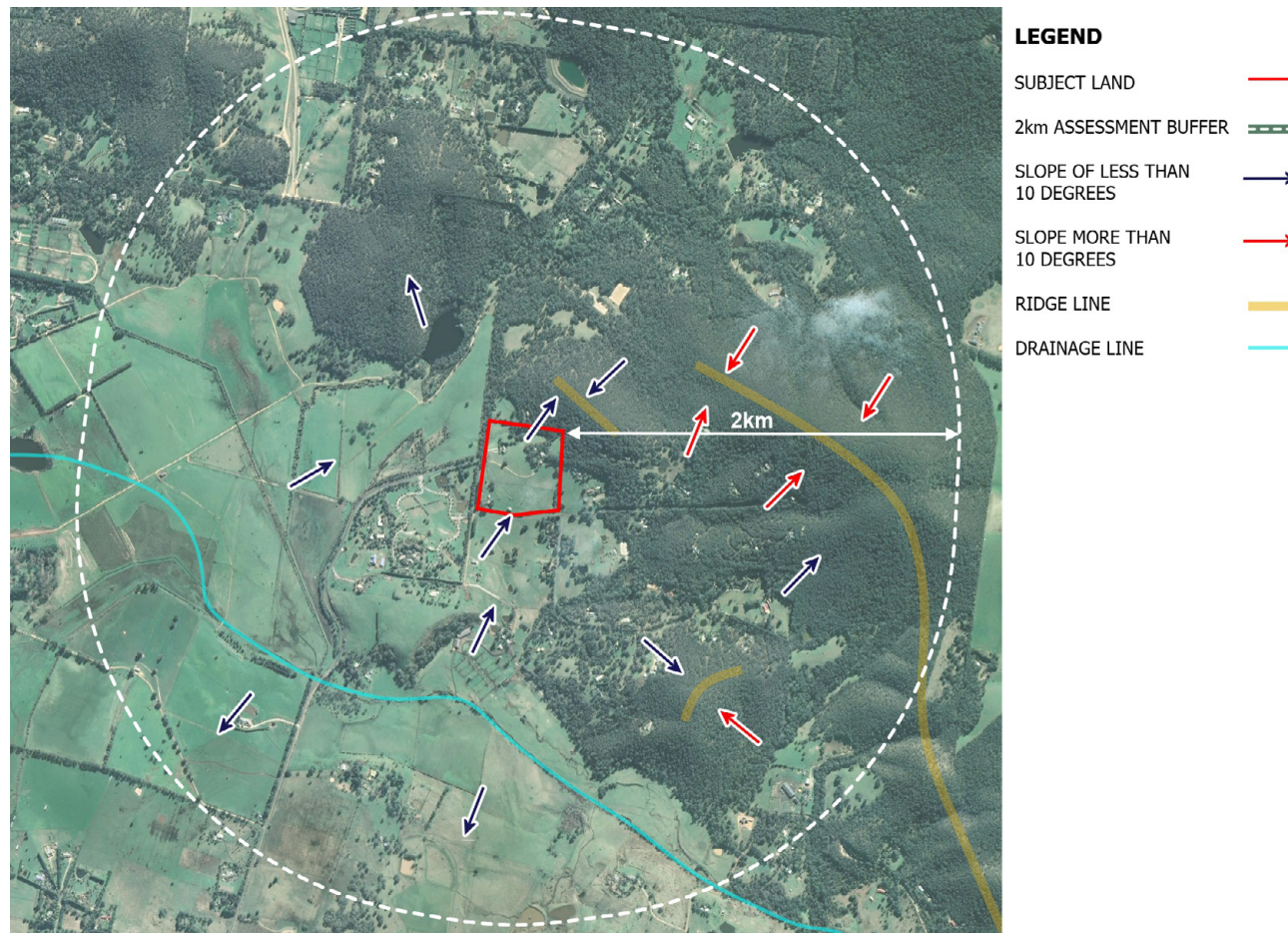
C Assess and map effective slope

Using a desktop assessment, distinguish between the following slopes:

- All upslopes and flat land (0 degrees)
- Downslope (more than 0 to 10 degrees)
- Downslope (more than 10 degrees)
- Ridge lines and peaks.

It is suggested these are annotated as slope arrows rather than plots. Please note the definition of effective slope is defined in AS3959.

Figure 29: Example of effective slope

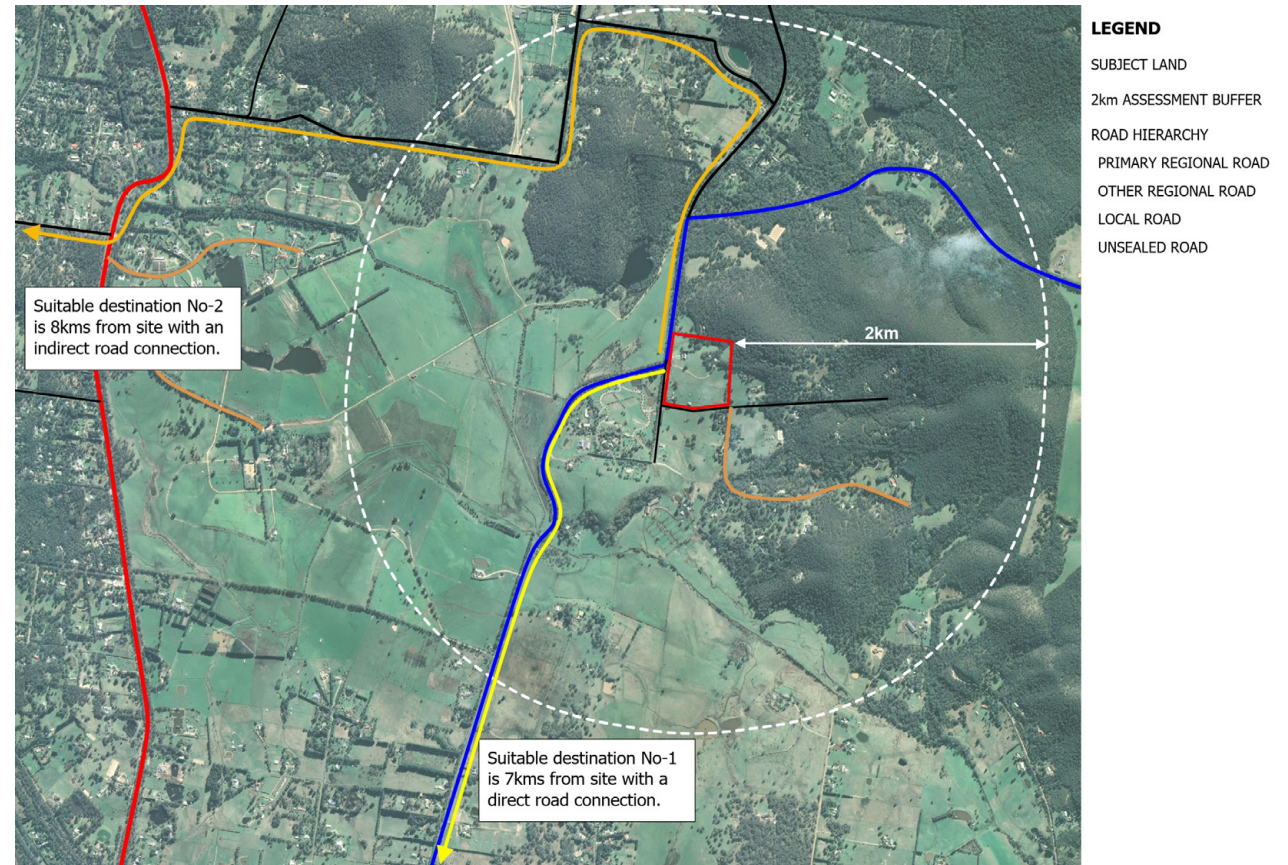




D Assess and map access routes

- Identify and map the existing and proposed (if known) roads leading to a suitable destination(s)
- Identify road hierarchy (see Liveable Neighbourhoods)
- Inclusion of road standards (sealed or other)
- Spatially differentiate between direct road access, including straight roads with extended view lines (grid or modified grid pattern) or complex road patterns (curved or cul-de-sac pattern)
- Annotate any impediments to use of the access routes.

Figure 30: Example of Access Routes





Step Four: Establish the broader landscape type

Use the points-based system in Table 6 to determine the broader landscape type for the planning proposal. The first column lists each criterion to be considered. In addition to the criteria column there are three columns with descriptors that relate to the criterion and provide corresponding assigned points listed in the header row (5 points, 2 points and 1 point). The final column is for noting the point(s) assigned for each criterion. The points column should be tallied and the sum of points listed in the total points cell. The total points are then used to derive the broader landscape type as indicated at the bottom of Table 6.

Determination of a broader landscape type should be supported by explanatory text commensurate with the scale and complexity of the planning proposal and/or the broader landscape type identified. Where the planning proposal adjoins land with an approved structure plan or subdivision, which has been assessed under SPP 3.7 (2015 or 2023) and proposes a post-development BAL-LOW, but is yet to be developed, this can be treated as an area that does not present an external bushfire hazard.

Table 6: Points-based system for determining a broader landscape type

CRITERIA	5 POINTS	2 POINTS	1 POINTS	POINTS
Proximity of the planning proposal to a suitable destination (as the crow flies):	Remote	Not adjoining but within 1 km	Adjoins (next lot)	
The road pattern immediate to the planning proposal is:	Complex and indirect (curved roads, cul-de-sacs, and/or multiple intersections)	Mixed road patterns	Direct and/or Straight view lines (grid or modified grid)	
Public road access to a suitable destination from the planning proposal is:	Provided to one suitable destination	N/A	Provided to two suitable destinations	
Exposure of the planning proposal to an identified external bushfire hazard (excluding Class G Grassland) is from:	Four aspects	Three aspects; and/or any of the identified aspects has a slope under the vegetation of more than 10 degrees	From nil, one or two aspects only; and all of the identified aspects have a slope under the vegetation of less than 10 degrees	
Total points				
Total points	Broader landscape type			
0 - 5 points	Broader landscape type A (BLT A)			
6 - 14 points	Broader landscape type B (BLT B)			
15 - 20 points	Broader landscape type C (BLT C)			
Broader landscape type determined				



Figure 31: Broader landscape type A aerial examples

Broader landscape type A

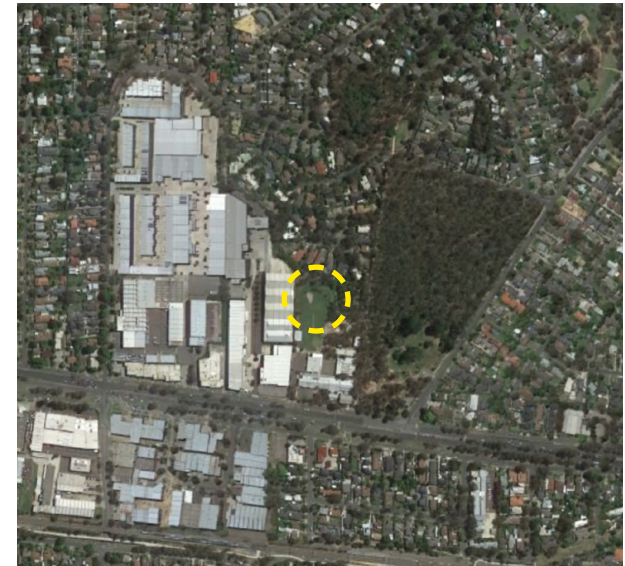
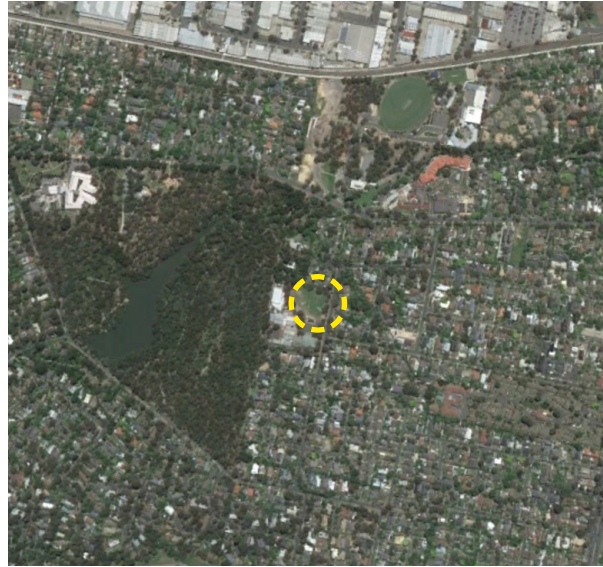




Figure 32: Broader landscape type B aerial examples

Broader landscape type B

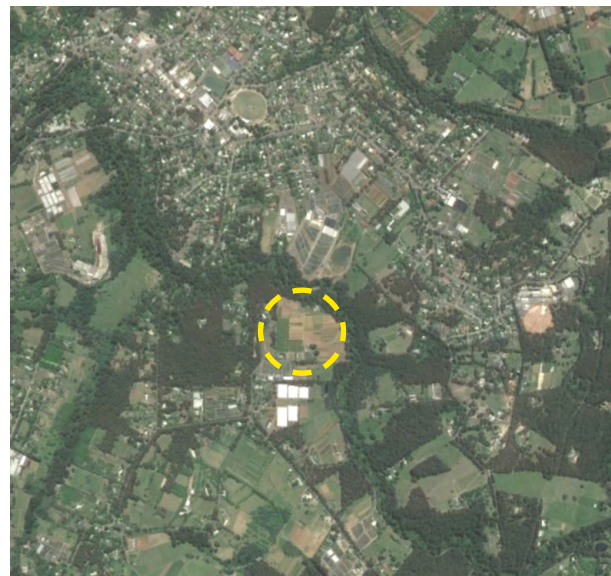
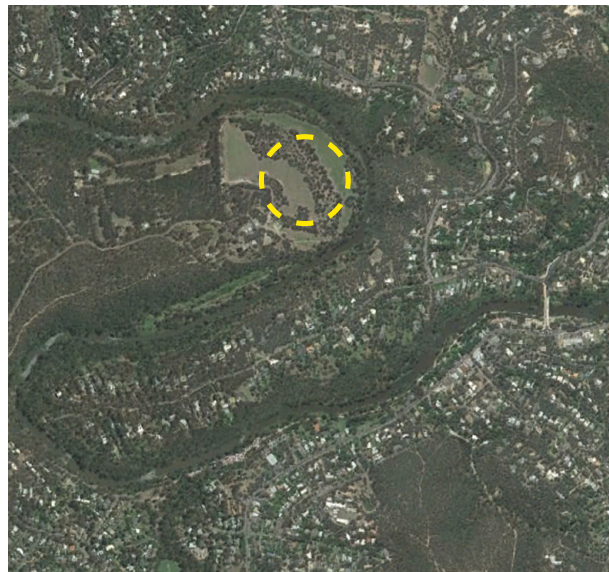




Figure 33: Broader landscape type C aerial examples

Broader landscape type C





Step Five: Assessment requirements for each broader landscape type

1 BLT A assessment:

A BLT A presents a lower risk of a landscape-scale bushfire. It is considered the risk can be mitigated through compliance with Elements 2 – 4 of the Guidelines. No further assessment of Element 1: location is necessary. Compliance with other elements in accordance with the relevant sections of the Guidelines is required.

2 BLT B assessment:

A BLT B presents more risk of a landscape-scale bushfire than a BLT A. Further analysis is required. Where a planning proposal is located in an area that is a BLT B, it should be demonstrated that:

- The risks presented by the broader landscape can be mitigated to an acceptable level, using the bushfire protection criteria contained in Elements 2 – 4 or any additional mitigation measures; and
- The planning proposal maintains or improves the evacuation capacity of the road network in the event of a bushfire and does not make the current situation worse; and
- Evacuation to a suitable destination in the event of a bushfire can be achieved.

If proponents are unable to demonstrate compliance with the above requirements, an outcomes-based approach is required.

Assessments should discuss how the bushfire risk from external hazards could impact the planning proposal and, if classified vegetation is to remain within the planning proposal, discuss the potential for a bushfire to run into and through the site.

When considering access routes, information should be presented on the internal road network (proposed) and the external broader road network (existing). The assessment should also consider suitable destinations together with the evacuation capacity for current road users and proposed road users associated with the proposal, to assist in determining the overall impact.

Where the decision-maker is of the opinion that this level of information is not sufficient to provide confidence that the proposal will not make the current situation worse, further information may be necessary.

3 BLT C assessment:

A BLT C presents an unacceptable bushfire risk of a landscape-scale bushfire resulting in significant loss of property and potential loss of life. It does not satisfy the acceptable solutions for Element 1: location. The bushfire risk is unlikely to be managed or mitigated through use of the Guidelines' bushfire protection criteria and intensification of land use or development should be avoided.

Where a practitioner considers that further analysis could demonstrate to the decision-maker that the broader landscape does not present an unacceptable risk and/or that the risks can be appropriately mitigated, an outcomes-based approach can be prepared. Further explanatory notes are provided in Section 3 and Appendix A.1 of the Guidelines.



APPENDIX B.2 – BUSHFIRE HAZARD LEVEL (BHL) ASSESSMENT

B.2.1 WHAT IS A BHL ASSESSMENT

A BHL assessment provides a ‘broad brush’ means of assessing the potential intensity of a bushfire for an area. It assists in informing the suitability of land contained within strategic planning proposals for future development.

B.2.2 WHEN SHOULD A BHL ASSESSMENT BE USED

A BHL assessment should be undertaken for any area identified for intensification of land use, at the strategic planning stage or structure plan stage when details of the lot layout or internal road network are not yet known.

B.2.3 WHO CAN PREPARE A BHL ASSESSMENT?

It is strongly recommended that BHL assessments are prepared by an accredited Level 2 or Level 3 bushfire planning practitioner.

B.2.4 BHL ASSESSMENT METHODOLOGY

The assessment methodology categorises the BHL as low, moderate or extreme based on the vegetation and slope within 150 metres of the subject site.

Traditionally, a BHL assessment is based on the current or pre-development state of the vegetation. However, in instances where the pre-development BHL is extreme, the

assessment fails to demonstrate that, with careful design and vegetation modification, the BHL could be reduced to a medium or low hazard level, which is recognised as suitable for development or land use intensification.

Where the areas identified within the subject site for land use intensification have a predominant pre-development BHL of extreme, a vegetation survey should be provided to demonstrate to the decision-maker that vegetation clearing or modification is possible to reduce the hazard level to moderate or low.

Alternatively, where concept plans are available for the subject site, a post-development BHL assessment should be undertaken, based on the post-development state of the vegetation, once subdivision or development works are complete.

A BHL assessment should be prepared in accordance with this Appendix with consideration for the predominant classified vegetation for a site (Table 7).

Table 7: BHL and vegetation classification (as per AS 3959)

HAZARD LEVEL	CLASSIFICATION/CHARACTERISTICS
Extreme	<ul style="list-style-type: none"> • Class A: Forest • Class B: Woodland • Class D: Scrub • Any classified vegetation with a greater than 10-degree slope
Moderate	<ul style="list-style-type: none"> • Class C: Shrubland • Class E: Mallee/Mulga • Class G: Grassland, including sown pasture and crops • Vegetation that has a low hazard level, but is within 100 m of vegetation classified as a moderate or extreme hazard, is to adopt a moderate hazard level
Low	<ul style="list-style-type: none"> • Low threat vegetation, which may include mangroves and other saline wetlands, areas of maintained lawns, golf courses (such as playing areas and fairways), maintained public reserves and parklands, sporting fields, vineyards, orchards, banana plantations, market gardens (and other non-curing crops), cultivated gardens, commercial nurseries, nature strips and windbreaks. • Managed grassland in a minimal fuel condition, meaning there is insufficient fuel available to significantly increase the severity of the bushfire attack, for example, short-cropped grass to a nominal height of 100 mm. • Non-vegetated areas, waterways, exposed beaches, roads, footpaths, buildings or rock outcrops.



Step One: Determine the area to be assessed

- The BHL assessment area is the defined subject site and all land within 150 metres of the external boundary of the subject site.
- Use an appropriate aerial image (where available) to define the area that is the subject of the BHL assessment. The aerial image should be as current as possible and scaled to clearly show the vegetation density and structure.

Step Two: Identify pre-development vegetation type(s) and slope

- Classify all vegetation within the BHL assessment area, preferably through a site inspection and in accordance with Table 7 to identify the predominant vegetation type(s) on the site.
- Provide photographic evidence in addition to aerial imagery and/or vegetation mapping data to verify low or moderate BHL areas. Where evidence of the vegetation height is required (such as shrub and scrub), a height stick or other appropriate indicator of height, should be included in the images.
- Further evidence may be required if the decision-maker is not satisfied with the aerial or photographic evidence provided.
- All slopes within the BHL assessment area need to be defined with land contour information.

Information to include in a pre-development vegetation classification map

- An aerial image of the BHL assessment area should form the base map and be overlaid with the following information:

- areas of classified vegetation and excluded vegetation (if any) in the form of plots
 - land contours for slope calculation
 - photo points to indicate where photos of vegetation have been taken
 - any other features of the BHL assessment area that are relevant bushfire considerations, such as native vegetation that may be listed and protected under environmental legislation.
- The pre-development vegetation classification map should be presented separately to other figures or maps to ensure the information is legible.

Step Three: Map the BHL results

An aerial image of the BHL assessment area appropriately scaled at a maximum 1:25,000 should form the base map and be overlaid with the following information:

- boundaries of the subject site and surrounding 150 metre area
- the strategic planning proposal concept design as an overlay
- assigned hazard levels for vegetation in the BHL assessment area based on the vegetation classification and slope from the vegetation classification map.

B.2.5 BHL ASSESSMENT MAP SPECIFICATIONS

The colours for each hazard level in the BHL assessment map should follow the colour codes (Table 8).

The BHL colours should be displayed at a transparency level of 25 per cent and no more than 35 per cent, as the colour boundary differentiation is compromised. This provides for clear distinction between the hazard levels and for the vegetation on the underlying aerial image to be 'visible'.

Table 8: BHL assessment map colour codes for classifying vegetation



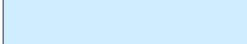
HAZARD LEVEL	COLOUR	RGB CODE	HEX CODE	COLOUR PATCH
Extreme	Red	R-238, G-50, B-36	EE3224	
Moderate	Yellow	R-255, G-238, B-0	FFEE00	
Low	Light blue	R-206, G-237, B-255	CEEDFF	



Figure 34: Sample vegetation classification map (BHL assessment)

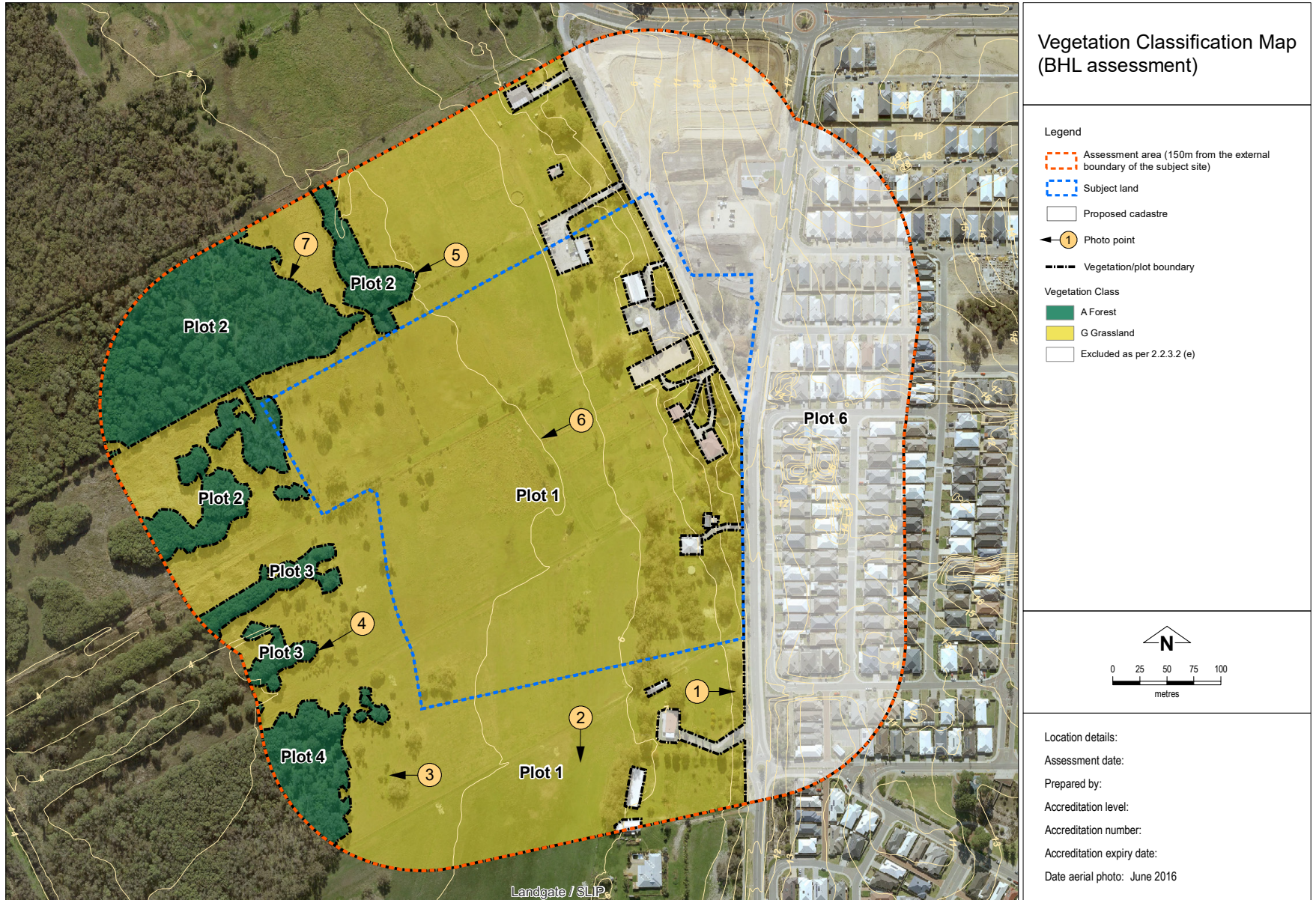
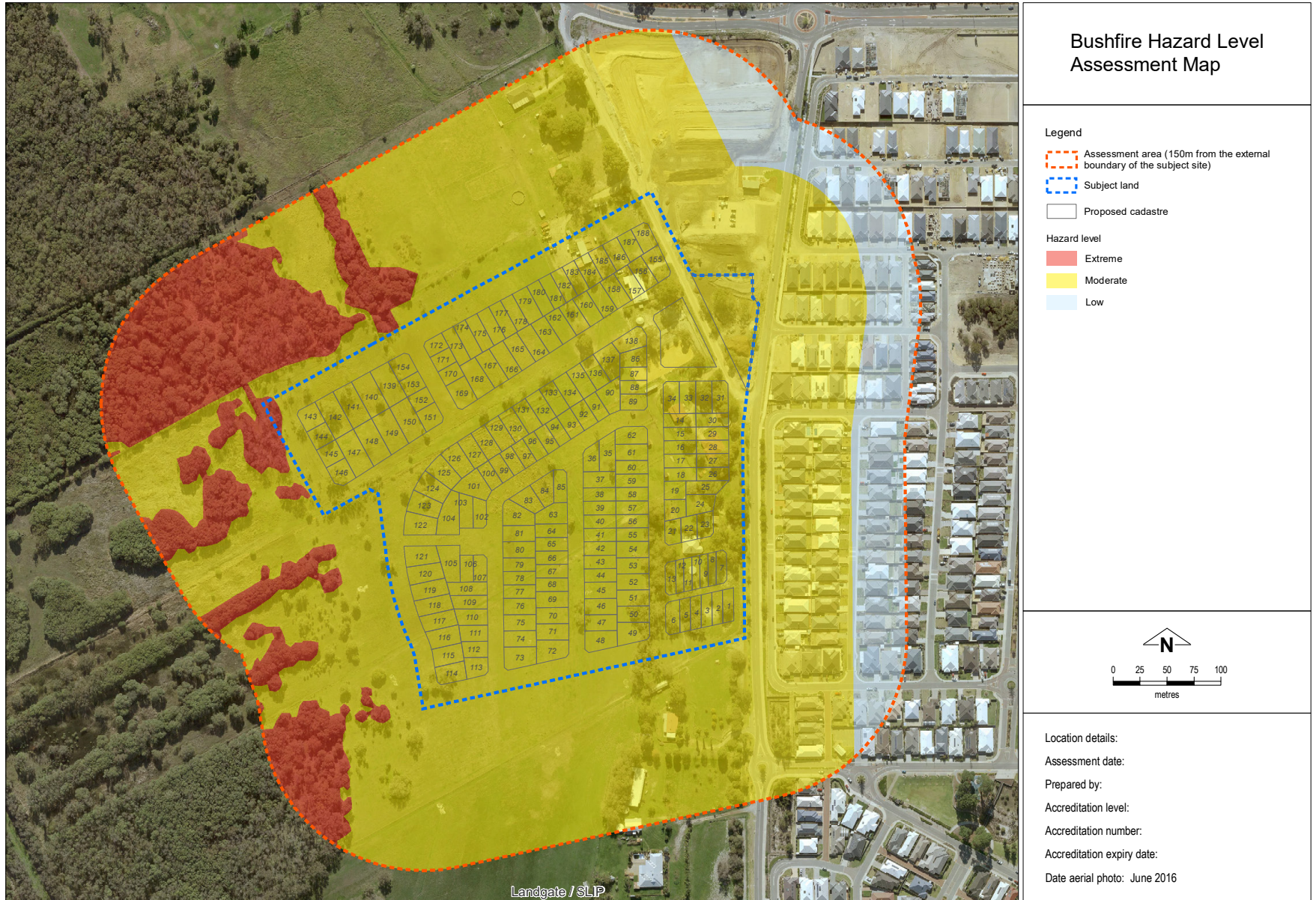




Figure 35: Sample BHL assessment map





APPENDIX B.3 – BUSHFIRE ATTACK LEVEL (BAL) CONTOUR MAP

B.3.1 WHAT IS A BAL CONTOUR MAP

A BAL Contour Map is a scale map of the subject site and surrounds. It uses the principles of AS 3959 to illustrate the potential radiant heat impacts and associated indicative BAL ratings to the subject lot(s), in reference to any classified vegetation remaining within 150 metres of the subject site, after development or subdivision works are complete.

It assumes that the site is in a 'post development state' such as when earthworks, clearing and/or landscaping have been completed. The BAL ratings are shown as descending contours of radiant heat, which reflect the separation distance increasing away from the classified vegetation towards the site. A BAL Contour Map should be accompanied by a vegetation classification map that shows the location of predominant vegetation types that will remain post development, to provide context of the bushfire risk to the subject site.

B.3.2 WHEN SHOULD A BAL CONTOUR MAP BE USED

A BAL Contour Map should be used at the subdivision stage but is also appropriate for strategic planning proposals where the lot layout and/or internal road network is known. It is also a useful assessment tool for development applications that include multiple development sites and/or habitable buildings.

Where a subdivision is proposed to be developed in stages, a new BAL Contour Map should be prepared for each stage.

B.3.3 WHO CAN PREPARE A BAL CONTOUR MAP

It is strongly recommended that a BAL Contour Map is prepared by an accredited Level 2 or Level 3 bushfire planning practitioner.

B.3.4 BAL CONTOUR MAP AND COMPLIANCE CERTIFICATE

A BAL Contour Map can include determined or indicative BAL ratings. An indicative BAL is based on further actions being completed to achieve that BAL rating, such as modification or removal of vegetation, or new development occurring. A determined BAL is when the BAL rating is in accordance with AS 3959, without the requirement for further site works or other actions to be completed.

Where a BAL Contour Map includes BAL ratings that are based on future site works, such as clearing and modification of vegetation, the subdivision approval may be conditioned to require the preparation of a compliance certificate. After the site works have been completed, a compliance certificate may be issued to certify that the BAL ratings shown on the BAL Contour Map remain accurate and compliant. This will allow decision-makers to have confidence that the BALs indicated in the BAL Contour Map are accurate and can be used to support a future development or building permit application.

It is strongly recommended that the compliance certificate be undertaken by the bushfire planning practitioner who prepared the original BAL Contour Map or, alternatively, any other accredited Level 2 or Level 3 bushfire planning practitioner. The relevant local government may be able to undertake this compliance check as part of the clearance of subdivision conditions.

For larger lots, such as a rural property, where the location of a development site may not be known, the use of a compliance certificate may not be appropriate. In this instance, it is likely that a new BAL assessment will be required to support the development or building permit application.

B.3.5 BAL CONTOUR MAP METHODOLOGY

A BAL Contour Map should be prepared in accordance with this Appendix.

Step One: Identify vegetation type(s) and slope.

Output - Vegetation classification map

How to create a vegetation classification map

- Include the subject site and all land within at least 150 metres of the external boundary of the site in the vegetation assessment area, to assist in determining the predominant vegetation types and provide context of the bushfire risk adjoining the site.¹

¹ In certain instances (such as a large rural lot, which is grassland), a BAL Contour Map does not need to be applied to an entire lot; rather, the BAL Contour Map needs to demonstrate that a suitable sized development will be able to be accommodated within an area of BAL-29 or below within each lot (or proposed lot). The BAL Contour Map should clearly articulate the methodology used.



- Use an appropriate aerial photo (where available) to define the assessment area that is to be the subject of the vegetation classification map. The aerial photo should be as current as possible and at a scale that clearly shows the vegetation density and structure.
- Classify all vegetation within the vegetation assessment area through a site inspection and provide photographic evidence for all relevant locations on the BAL Contour Map area. The vegetation should be classified in accordance with Table 2.3 and Figures 2.4 (A) to 2.4 (H) of AS 3959 and the Visual guide for bushfire risk assessment in Western Australia (Department of Planning: 2016).
- Analyse land contour information and define the slope for each assessment transect.
- Record the inputs for classified vegetation (in the form of plots) and effective slope in a table format. The inputs should include the actual or proposed post development separation distance from the classified vegetation.

Information to include in a vegetation classification map

- A vegetation classification map should be at a scale where individual lot(s) and the location of the existing and proposed development can be clearly identified.
- An aerial image of the vegetation assessment area should form the base map and be overlaid with the following information:
 - areas of classified vegetation and excluded vegetation (if any) in the form of plots
 - land contours for slope calculation / slope transects displayed

- areas where vegetation is proposed to be cleared or revegetated (if applicable)
- photo points to indicate where images of vegetation have been taken
- any other features of the subject site that are relevant bushfire considerations.

The vegetation classification map should be presented separately from the BAL Contour Map to ensure the information is legible.

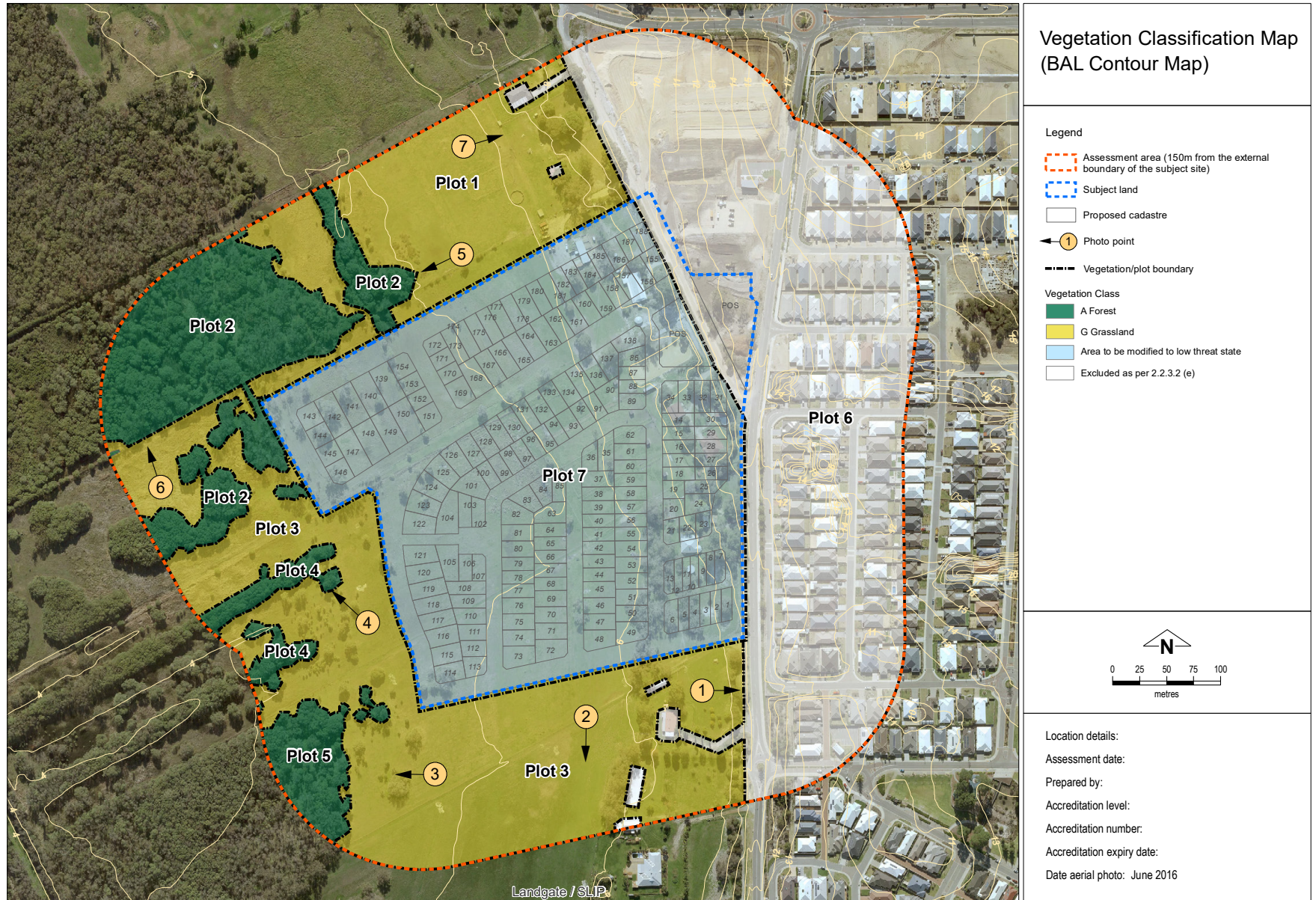
Table 9: Vegetation classification map colour codes for classifying vegetation

VEGETATION CLASSIFICATION	COLOUR	RGB CODE	HEX CODE	TRANSPARENCY	COLOUR PATCH (OVER A WHITE BASE)
Classified vegetation					
A Forest	Red	R-199,G-48,B-43	#c7302b	40%	
B Woodland	Green	R-47,G-155,B-2	#2f9b02	50%	
E Shrubland	Pink	R-229,G-44,B-223	#e52cdf	35%	
D Scrub	Light orange	R-248,G-152,B-0	#f89800	50%	
E Grassland	Light yellow	R-241,G-241,B-99	#f1f163	35%	
Excluded vegetation					
Existing low fuel area (e.g. existing developed residential lots)	White	R-245,G-245,B-220	#f5f5dc	50%	
Managed parkland*	Light green	R-129,G-253,B-4	#81fd04	60%	
Vineyard/orchard*	Lime green	R-0,G-252,B-0	#00fc00	50%	
Water body	Dark blue	R-10,G-22,B-52 (inner) R-2,G-6,B-248 (border)	#0a1634 (inner) #0206f8 (border)	40% (inner) 0% (border)	

* Assessed as being in a low fuel state as per AS 3959.



Figure 36: Sample vegetation classification map (BAL Contour Map)





Step Two: Map the BAL contours.

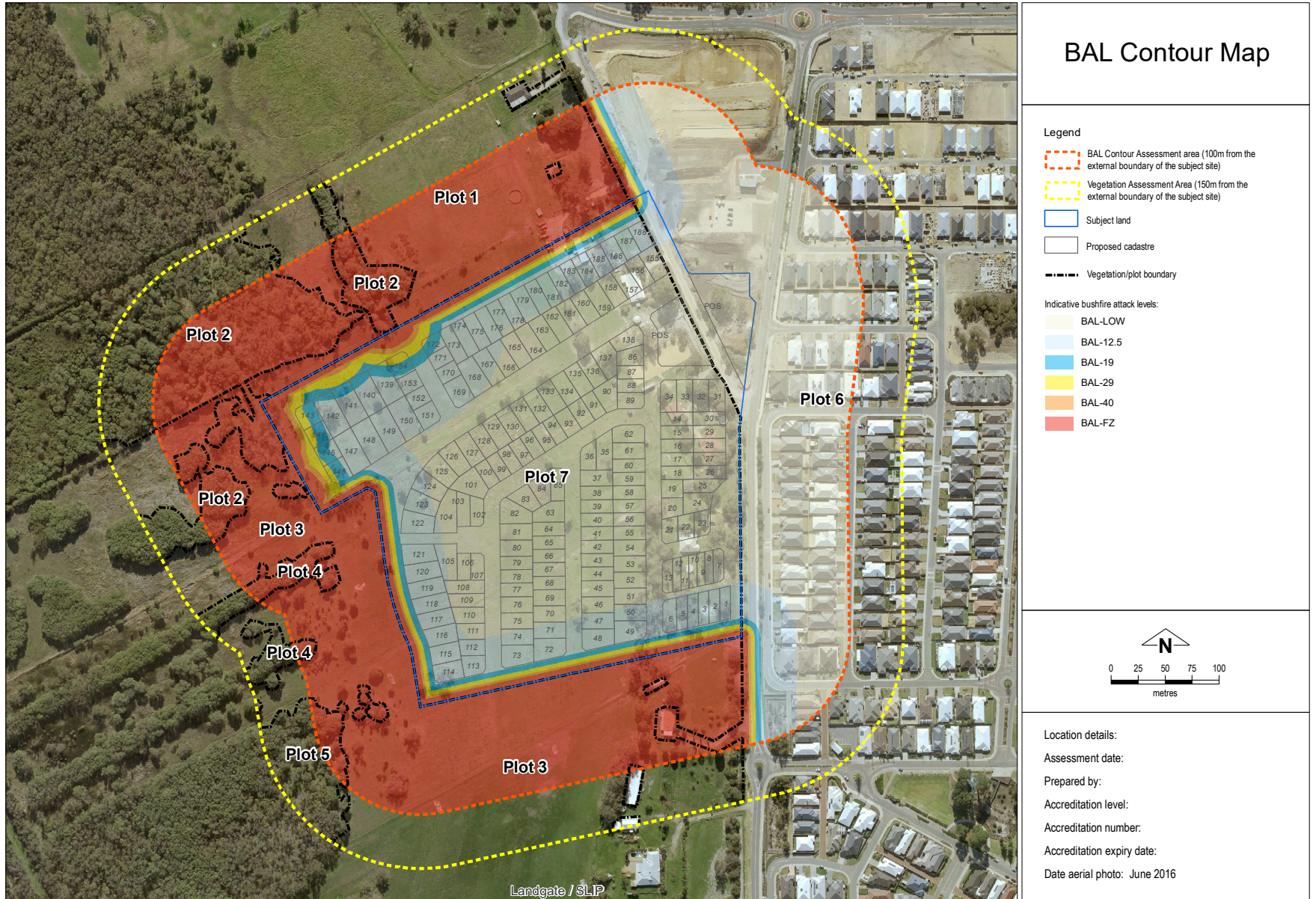
Output - BAL Contour Map

How to create a BAL Contour Map

- Use an appropriate aerial photo (where available) to include the subject site and all land within at least 150 metres from the site and indicate this as the vegetation assessment area. The aerial photo should be as current as possible and at a scale that clearly shows the vegetation density and structure.
 - Define the assessment area that is to be the subject of the BAL Contour Map by indicating the area within 100 metres of the external boundary of the subject lot/s or 100 metres from the building footprint for existing and proposed development.
 - Using the principles of AS 3959 (for example, slope of the land under the classified vegetation), indicate the BAL rating at each assessment transect.
 - The assessment transects should be done at a frequency and location dictated by site conditions to represent the worst-case scenario. This is typically where the slope and/or vegetation changes. Assessment transects should be allocated across the assessment area, even where such areas have the potential to be within a BAL-LOW contour.
 - BAL contours should be produced across all relevant BAL ratings, including areas of BAL-LOW, and coloured in accordance with Table 10.
 - Where multiple BAL ratings may apply to a single location, the higher BAL rating should be applied.
- The BAL Contour Map should be based on the future state of the site (such as when subdivision works have been undertaken), including any vegetation that will remain or will be introduced when the works are complete.
 - The inputs used to determine the BAL contours (such as the lot number, vegetation classification, effective slope, actual separation distance, indicative BAL rating-output) should be included in the BMP in a table format with a row matched to each assessment transect along the contour.



Figure 37: Sample BAL Contour Map








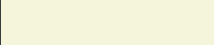


B.3.5 BAL CONTOUR MAP SPECIFICATIONS

The colour code for each BAL contour is shown in Table 10.

The coloured BAL contours should be displayed at a transparency level of 25 per cent and no more than 35 per cent. This provides for clearer distinction between the different BAL contours; and for the vegetation on the underlying aerial image to be ‘visible’, providing for informed decision making as the vegetation can be ‘seen’ in its context.

Table 10: BAL Contour Map – colour codes for contours

BAL RATING	COLOUR	RGB CODE	HEX CODE	TRANSPARENCY	COLOUR PATCH
BAL-FZ	Red	R-238, G-50, B36	EE3224	25-35%	
BAL-40	Orange	R-248, G-152, B-40	F89828	25-35%	
BAL-29	Yellow	R-255, G-238, B-0	FFEE00	25-35%	
BAL-19	Blue	R-0, G-174, B-239	00AEEF	25-35%	
BAL-12.5	Light blue	R-206, G-237, B-255	CEEDFF	25-35%	
BAL-LOW	Beige	R-245, G-245, B-220	F5F5DC	25-35%	



APPENDIX B.4 – BAL ASSESSMENT

B.4.1 WHAT IS A BAL ASSESSMENT

A BAL assessment outlines the calculations, assumptions and supporting information for a bushfire attack level determined in accordance with Method 1 or Method 2 of AS 3959. This determined BAL is a measure of the severity of a building or development site's potential exposure to ember attack, radiant heat and direct flame contact, using increments of radiant heat expressed in kW/m². There are six different BALs that provide for increasing levels of ember attack, radiant heat or direct flame contact (Table 1 and Figure 4). The higher the BAL, the more bushfire resistant construction will be required for the building or development.

Where a BMP is required, the BAL assessment will form part of the BMP.

B.4.2 WHEN A BAL ASSESSMENT SHOULD BE USED

A BAL assessment is required at the development application stage for habitable buildings located in a designated bushfire prone area. A BAL may also be required at the building permit stage, including for Class 1, 2 or 3 buildings and associated Class 10a buildings and decks in designated bushfire prone areas.

B.4.3 WHO CAN PREPARE A BAL ASSESSMENT

It is strongly recommended that BAL assessments are prepared by accredited Level 1 BAL assessors or accredited Level 2 or 3 bushfire planning practitioners.

B.4.4 BAL ASSESSMENT REQUIREMENTS

A BAL assessment should be prepared in accordance with AS 3959. A BAL assessment should at a minimum include the following information.

1 Site and assessor details

Information that clearly identifies the location of the building or development (such as a street address, or where a street address is not available, a reserve number or other identifier), the person who undertook the assessment, including contact details and accreditation number (if applicable) and the date the assessment was undertaken.

2 Site map

A site map that clearly identifies all vegetation classified in accordance with AS 3959 that is within a minimum 100 metre radius of the development site. This map should also show the location of the development, the distances between the classified vegetation and that development, any roads or driveways, north point and information about where and in which direction photos of the site have been taken.

3 Photographs

Photographs that clearly represent all areas of vegetation classified in accordance with AS 3959 and for any areas that may be subject to an exclusion clause under AS 3959. Each photo should be accompanied by a written justification outlining the reasons for the classification or exclusion. Each photo should be clearly labelled and referenced on the site map.

The Visual guide for bushfire risk assessment in Western Australia (Department of Planning: 2016) provides further guidance for classifying vegetation in a Western Australian context. It is important to note that the Visual guide does not replace the requirements of AS 3959 and that AS 3959 takes precedence in any inconsistency between AS 3959 and the Visual guide.

4 Potential bushfire impacts

A table or similar format should set out each area of classified vegetation and record the distances and other related details (such as slope under the vegetation) that have been used in the calculation of the BAL. BAL assessments undertaken in accordance with Method 2 of AS 3959 should clearly set out all the inputs and assumptions used to determine the BAL. The BAL assessment for the site should accurately reflect the bushfire risk on site at the time of the inspection and the determined BAL will be based on the highest BAL applicable to the building or development.

5 Additional guidance

Any additional guidance such as the indicative BALs that may be achieved on-site should certain works be undertaken – including clearing or site works, elevations that may be considered shielded in accordance with AS 3959 or APZ requirements – should be kept separate from the calculations and information used to determine the current BAL. Such information should be clearly identified as guidance or additional information and contained within a separate table or appendix to the BAL assessment.



APPENDIX B.5 – BAL ASSESSMENT (BASIC)

A BAL assessment (basic) process may be used in place of a BAL assessment where a building or proposed building, as part of a development application, is located more than 100 metres from bushfire prone vegetation.

B.5.1 WHAT IS A BAL ASSESSMENT (BASIC)

A BAL assessment (basic) is a simplified process for determining the BAL for a building, or proposed building, that has a low risk of bushfire exposure because it is located more than 100 metres from bushfire prone vegetation.

A BAL assessment (basic) report determines the BAL rating in accordance with the Simplified Procedure (Method 1) of AS 3959.

If you are a landowner/proponent, developer or builder lodging a development application and you are proposing to develop on a site in a designated bushfire prone area, you may use a BAL assessment (basic) report if:

- your site and the surrounding area have been cleared since the latest release of the *Map of Bush Fire Prone Areas* was published, resulting in there being more than 100 metres between any bushfire prone vegetation and the location of the building, or proposed building; or
- the site is designated bushfire prone but the subject land is large enough to locate the building, or proposed building, in an area that it is more than 100 metres from any bushfire prone vegetation.

A BAL assessment (basic) can only be undertaken at the development application stage and not the structure plan or subdivision stage.

B5.2 BAL ASSESSMENT (BASIC) PROCESS

The BAL assessment (basic) process contains two steps that satisfy the requirement for determining a BAL using the Simplified Procedure (Method 1) set out in clause 2.2 of AS 3959.

You can find the BAL assessment (basic) report under the section 'Forms' of the 'Bushfire Planning Publications' page on DPLH's website. Complete the report using the following steps.

Step One: Determine if the distance between the building, or proposed building, and the bushfire prone vegetation is more than 100 metres

Step 1 is a determination of the horizontal distance(s) between the building, or proposed building, and any bushfire prone vegetation in the vicinity. These measurements are required to ensure that the distance between the building, or proposed building, and any bushfire prone vegetation is more than 100 metres.

Bushfire prone vegetation includes most types of vegetation, including trees, shrubs and unmanaged grasses (including sown pastures and crops). However, bushfire prone vegetation does not include:

- low threat vegetation (i.e. grassland managed in a minimal fuel condition, maintained/mowed lawns, golf courses, public recreation reserves and parklands, vineyards, orchards, cultivated gardens, commercial nurseries, nature strips and windbreaks); and

- non-vegetated areas (i.e. waterways, roads, footpaths, buildings or rock outcrops).

The measurement is the horizontal distance (i.e. measured in plan) that is taken (Figure 38):

- from where the external walls of your building are, or proposed building will be, to the base of the bushfire prone vegetation (not the canopy); or
- for a part of the building that has no wall (e.g. carport, verandah, deck, landing, ramp) from the supporting posts/columns to the base of the bushfire prone vegetation.

A measurement is required between the building, or proposed building, and all areas of bushfire prone vegetation in the vicinity of the site. This means that for some sites with multiple areas of bushfire prone vegetation nearby, multiple distances will need to be measured and recorded for the consideration of the decision-maker or building surveyor. When there are multiple areas of bushfire prone vegetation within the vicinity of the site, the shortest measurement recorded will be the one nominated on the BAL assessment (basic) report.

For example, if the measurement to the first area of bushfire prone vegetation is 115 metres and the measurement to the second area of bushfire prone vegetation is 120 metres, then 115 metres will be the measurement nominated on the BAL assessment (basic) report.

Online mapping tools (such as Google Maps) can be used to assist in determining what the horizontal distance is between the bushfire prone vegetation and the building, or proposed building.



Supporting information (such as site plans, photos, aerial photography and other design documents and specifications) must also accompany your BAL assessment (basic) report as evidence that your building, or proposed building, is more than 100 metres from any bushfire prone vegetation.

If the distance is 100 metres or less between any bushfire prone vegetation and the building, or proposed building, then you should not undertake a BAL assessment (basic). If this applies to you, you should cease this process and engage an appropriately qualified and experienced person (such as an accredited Level 1 BAL Assessor or Level 2 or Level 3 bushfire planning practitioner) to undertake a BAL assessment.

Step 1: Measure the distance(s) between the building, or proposed building, and all areas of bushfire prone vegetation.
Insert the lowest distance (in metres) in the corresponding box on the BAL assessment (basic) report.

Step Two: Determine the bushfire attack level (BAL)

Clause 2.2.3.2 of AS 3959 provides that the bushfire attack level is classified BAL-LOW where the distance between the building, or proposed building, and any bushfire prone vegetation is more than 100m when measured in the horizontal plane.

If the distance stated in Step 1 is more than 100 metres, then the BAL in accordance with AS 3959 is BAL-LOW.

Under AS 3959, a BAL-LOW classification generally means that there are no additional bushfire resistant construction requirements that apply to the building, or proposed building. However, it should be noted that the 2022 edition of the *Building Code of Australia* will introduce bushfire construction requirements for certain types of Class 9 buildings located in a designated bushfire prone area, even where the site is BAL-Low.

Step 2: If the distance nominated at Step 1 is more than 100 metres, insert LOW in the corresponding box on the BAL assessment (basic) report.

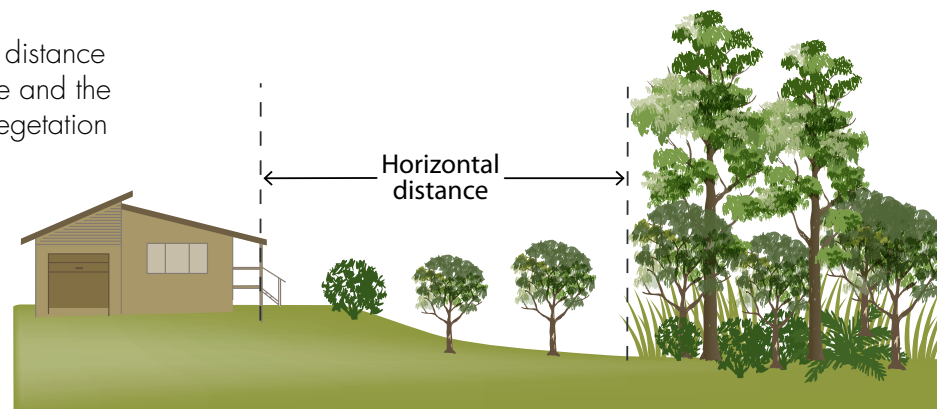
You should complete the BAL assessment (basic) report using the information found at each step of this process. You should submit your BAL assessment (basic) report as part of your application for development approval and/or to demonstrate compliance with the Building Code of Australia requirements under the building approval system.

Supporting information (such as site plans, photos, aerial photography, and other design documents as required by the decision-maker and/or registered building surveyor) must accompany the BAL assessment (basic) report as evidence that your building, or proposed building, is more than 100 metres from bushfire prone vegetation.

Where the decision-maker and/or registered building surveyor is satisfied your building, or proposed building, is more than 100 metres from bushfire prone vegetation, they may accept your BAL assessment (basic) report.

However, if the decision-maker and/or registered building surveyor is not satisfied with the accuracy of your BAL assessment (basic) (e.g. they believe that the distance between your building, or proposed building, and the bushfire prone vegetation is 100 metres or less) then you may be required to engage an appropriately qualified and experienced person (such as an accredited Level 1 BAL Assessor or Level 2 or Level 3 bushfire planning practitioner) to undertake a BAL assessment.

Figure 38: Measurement of distance between a house and the bushfire prone vegetation





A GUIDE TO DEVELOPING A BUSHFIRE MANAGEMENT PLAN (BMP)

C.1 WHEN SHOULD A BMP BE PREPARED

A BMP should be prepared as early as possible in the planning process and progressively reviewed and refined to reflect the level of detail at each planning stage.

A BMP should accompany strategic planning proposals, subdivision and development applications in designated bushfire prone areas, where proposed development and/or lot(s) have a BAL above BAL-LOW or a BHL above LOW.

Information provided in a BMP should be commensurate with the applicable planning stage and scale of the proposal or application.

C.2 WHO SHOULD PREPARE A BMP

It is strongly recommended that BMPs are prepared by an accredited Level 2 or Level 3 bushfire planning practitioner at the level appropriate to the complexity required.

C.3 USE OF AN EXISTING BMP

A landowner/proponent may use an existing BMP if it remains relevant. Circumstances where a new BMP should be submitted include:

- where conditions have changed, including surrounding development, vegetation classification or BAL rating

- where there is insufficient information to make an assessment
- to reflect new methodologies or policy requirements as identified in revisions of these Guidelines.

The decision-maker retains the right to request the landowner/proponent to update the bushfire assessment and/or BMP if they deem it necessary.

C.4 BMP TEMPLATES

BMP templates are located on the Department of Planning, Lands and Heritage's website. The standardisation of BMPs improves efficiencies in decision-making at local and State government level. The BMP templates promote the clear and succinct presentation of information required under SPP 3.7 and within the Guidelines. Below is a summary of the requirements.

Part 1: Proposal details

Include a brief explanation of the strategic planning proposal, subdivision or development and resulting intensification of land-use.

Acknowledge any known reports or plans prepared for previous planning stages that may refer to the subject area and may or will impact the assessment of bushfire risk, such as structure plans, environmental reports, landscaping plans or any relevant bushfire risk assessment.

Part 2: Environmental considerations

SPP 3.7 objective 5.4 recognises the need to consider bushfire risk management measures alongside environmental, biodiversity and conservation values.

The BMP should identify whether onsite clearing or modification of native vegetation will be required and whether areas within or adjacent to the subject site are proposed to be revegetated as part of the planning proposal.

The BMP should provide evidence (from relevant agencies, the environmental or planning consultant and/or the local government) that the vegetation clearing and/or modification will be supported. If evidence is unavailable, it may be satisfactory to identify the need to obtain these approvals at a subsequent stage of the planning process and to acknowledge that, if approval is not forthcoming, there may be a need to revise the BMP. This information should be provided in a statement demonstrating how a reasonable expectation of vegetation clearing approval at a future stage can be justified.

Where revegetation is proposed, written evidence and/or an approved landscape plan should be provided to demonstrate that the agency responsible for the ongoing management – such as local government and/or Department of Biodiversity, Conservation and Attractions (DBCA) – understands and supports the ongoing management responsibility and associated vegetation classification assigned to the subject area.

Part 3: Bushfire assessment

The bushfire assessment will be dependent on the type of strategic planning proposal, subdivision or development application and should be undertaken in accordance with the relevant bushfire assessment methodology contained within the Guidelines.



Part 4: Identification of bushfire hazard issues

Discuss any bushfire hazard issues identified through examination of the environmental constraints and opportunities and the bushfire assessment. This may include access constraints both within and outside of the site and the location of significant bushfire hazards both within the broader landscape and within the subject site, such as vegetation and slope.

Part 5: Assessment against the bushfire protection criteria

Each of the applicable bushfire protection criteria should be demonstrated by either addressing the relevant acceptable solutions or where these acceptable solutions cannot be met, an outcomes-based approach may be developed.

Acceptable solutions should be provided within a table and not duplicated in the body of the BMP.

Part 6: Responsibilities for implementation and management of the bushfire protection measures

This part should be set out in a table and list separately the responsibilities of the developer(s), the landowner(s) and the local government for the initial implementation and ongoing maintenance of the required bushfire risk mitigation measures.

Examples of responsibilities that should be included, where relevant, are:

The developer – prior to issue of certificates of title for new lots

- Construct the public roads to the standards stated in the BMP
- Construct the relevant fire service access routes and emergency access ways and associated signs and gates to the standards stated in the BMP
- Establish the public open space in a 'low threat' state as stated in the BMP
- Clearing and/or vegetation modification to be undertaken in accordance with the BMP
- Lodging a section 70A Notification on each Certificate of Title proposed by the subdivision.

The developer/landowner – prior to sale or occupancy or commencement of operation

- Establish the APZ to the dimensions and standard stated in the BMP and any accompanying Landscape Management Plan
- Where relevant, construct private driveways to the standards stated in the BMP
- Install the required private water tank within the lot, with a minimum 10,000 litres reserved for firefighting, that meets construction and vehicle access specifications
- Each property owner on sale of the allotment is provided with a copy of the BMP and informed of their responsibilities. A copy of the approved BMP should be attached to all contracts of sale for the lot.

The landowner – ongoing

- Maintain the APZ to the dimensions and standards as specified in the Landscape Management Plan and/or BMP
- Maintain any areas nominated to be revegetated in accordance with the classification and standards as specified in the Landscape Management Plan and/or BMP
- Maintain vehicular access routes within the lot to the required surface condition, gradient and clearances
- Maintain the firefighting water supply tank and its associated fittings and vehicular access in good working condition
- Ensure the ongoing implementation of the BMP, including providing successive landowners with a copy of the BMP and making them aware of the responsibilities outlined.



A GUIDE TO DEVELOPING A BUSHFIRE EMERGENCY PLAN (BEP)

D.1 WHEN SHOULD A BEP BE PREPARED

Policy measure 7.3iii of State Planning Policy 3.7: Bushfire, requires a BEP accompany development applications for vulnerable land uses. A BEP may be appropriate at the strategic planning stage or subdivision only where there is sufficient detail of the anticipated operation, including the number of persons on-site.

D.2 WHAT IS A VULNERABLE LAND USE

Vulnerable land uses are those where people may be less able to respond in a bushfire emergency. The identification of a proposal as vulnerable is at the discretion of the decision-maker. The application should be treated as 'vulnerable' and a BEP should be prepared where the decision-maker determines that – based on the capabilities of the occupants, the number of potential occupants, the development type or location – the proposal would benefit from a BEP to manage the safety of the occupants in a bushfire event.

D.3 WHO CAN PREPARE A BEP

It is strongly recommended that an accredited level 3 bushfire planning practitioner prepare a BEP.

TYPES OF VULNERABLE LAND USE	EXAMPLES
Land uses designed to accommodate occupants with reduced physical or mental ability such as the elderly, children (under 18 years of age) and the sick or injured.	Aged or assisted care, nursing home, education centre, childcare centre, hospital and rehabilitation centre.
Facilities that, due to building or functional design, offer limited access or the number of people may present evacuation challenges.	Corrective institution (prison) and detention centre.
Land uses that involve short-stay accommodation or visitation for people who are unaware of their surroundings and who would require assistance or direction in the event of a bushfire.	Caravan park and camping ground, holiday accommodation, serviced apartment (short-stay), tourist development and worker's accommodation.

D.4 WHO SHOULD BE CONSULTED IN THE PREPARATION OF A BEP

It is recommended to provide a copy of a BEP to the local fire service to assist in pre-incident planning, particularly in remote locations; however, the local fire service is not required to review or approve the BEP.

Local emergency management committees (LEMC) and emergency management agencies should be consulted in identifying and endorsing potential sites for on-site or off-site shelter. Buildings or areas identified as suitable for on-site shelter should be registered with the local government. Local governments should ensure that BEPs are consistent with the local government's Local Emergency Management Arrangements (LEMA).

D.5 WHAT IF AN EMERGENCY PLAN IS ALREADY IN PLACE

Many facilities have procedures to ensure the safe movement of employees and occupants in the event of an evacuation.

These procedures are normally referred to as an emergency plan as outlined in the following Australian Standards (AS):

- AS 3745-2010 – Planning for emergencies in facilities
- AS 4083-2010 – Planning for emergencies – Health care facilities.

An AS-based emergency plan has employees and occupants evacuate buildings to an assembly point in the event of an emergency. However, in the case of a bushfire emergency, these procedures may not adequately address the safety of occupants and other related issues.



For example, if the nominated assembly point is away from a building but close to an area of vegetation, people may be exposed to the heat and smoke created by the bushfire.

D.6 COMPONENTS OF A BEP

A BEP should identify appropriate procedures and actions for employees and occupants to follow prior to the bushfire season, during the bushfire season, in the event of a bushfire and after the bushfire has passed.

The BEP should be concise, using plain language suitable for the end-user, and be listed in a logical and sequential way so that the end-user can easily follow the process required. Repetition of tables and action statements in the BEP should be avoided.

Any supplementary information or information to assist the decision-maker, including the analysis on evacuation and on-site shelter options, should be presented in a separate document.

The contents of a BEP should follow the BEP template provided on the [Department of Planning, Lands and Heritage website](#).

The development of a BEP should be consistent with the following AS:

- AS 3745-2010 – Planning for emergencies in facilities
- AS 4083-2010 – Planning for emergencies – Health care facilities.

D.7 ESTABLISH AN EMERGENCY MANAGEMENT TEAM

An emergency management team is a group of people responsible for contributing to the development, documentation and review of a BEP. The emergency management team should at a minimum consist of an accredited Bushfire Planning Practitioner and the owner/operator of the facility.

The emergency management team should review the BEP regularly, especially when staff or circumstances change to ensure it remains practical and current.

D.8 SUPPORTING ANALYSIS

Step One: Identify facility details and analyse site and location characteristics

Preparing a BEP requires an understanding of how a bushfire may affect the site and the consequences for occupants.

The characteristics of the site and its occupants should be identified, including:

- the contextual location of the site
- the type of facility and the occupancy characteristics, including number of occupants, age profile, disability, mobility and health considerations, vulnerability and communication constraints
- the facility/site's vulnerability to bushfire, such as construction standards, design features, access, firefighting water supply, proximity to hazard and landscaping
- complementary bushfire protection strategies, proposed or existing, such as alert systems, suppression systems, training, and hazard management

- availability of buildings on-site, suitable for on-site shelter
- availability of off-site location(s), which may be suitable to provide shelter in the event of a bushfire, for occupants evacuating the subject site
- availability of safe evacuation route(s)
- availability of evacuation transport.

Step Two: Determine primary and secondary emergency actions (evacuation and on-site shelter)

In response to the bushfire threat, procedures need to be developed for evacuation and on-site shelter as the primary and secondary actions. This is to ensure that, if for any reason the primary action is not achievable, the facility is not left without a procedure to follow. The decision needs to be based upon a good understanding of the location, occupants and the effects of bushfire as well as information contained in official warnings issued by emergency services.

Early evacuation should always be the primary action – you should never 'wait and see what happens'. Sheltering on-site and actively defending a building will take huge physical and mental effort for many hours before, during and after the fire and conditions will be unbearably hot. However, bushfires are unpredictable and evacuation at the last minute ahead of a bushfire is dangerous due to smoke, noise, heat, flames, emergency vehicles and panic on the road. It is much safer to on-site shelter than flee as the fire approaches.

Sheltering on-site during a bushfire should be a last option, when all other plans fail, and occupants are unable to leave, or emergency services advise, through official warnings, that it is no longer safe to evacuate.



Early evacuation in response to an imminent bushfire threat may also be difficult for facilities in remote locations or facilities with people with morbidity issues. In these circumstances, sheltering on-site may be considered as the safer action. For day-use facilities in remote locations, consideration should be given to closure of the facility on higher fire danger rating days.

Step Three: Identify an off-site location (for evacuation)

When identifying an off-site location or a suitable destination to re-locate or evacuate to in the event of a bushfire, consideration should be given to the distance to the site, vehicular access routes, transportation arrangements, its size/capacity and ability to provide shelter prior to, during and after the bushfire. Consult with the local government, LEMC and the Department of Communities¹ when identifying an off-site location.

Depending on the extent of bushland areas around the facility, the location of a bushfire and the safest route from the property, there may be a need to identify two or three off-site locations and/or alternative safe routes depending on direction of spread of the fire.

Details of the off-site location(s) should be provided on a map within the BEP and should include street name and suburb, map reference, location/building name, location/building contact number if applicable and the possible route to be taken.

The following questions will assist the individual developing or reviewing the BEP to identify an off-site location. For an appropriate off-site location, the answers to the below questions should receive a 'yes'.

¹ The Department of Communities determines the number and location of evacuation centres to be opened in consultation with the DFES (the responsible/controlling agency for a bushfire emergency).

If there are occupants with support needs that require a similar facility to support them, is the off-site location suitable?

Yes
 No

- Occupants with support needs are people with physical, intellectual, visual or auditory disability or impairment, either temporary or permanent. It also includes aged persons and juveniles who are dependent on others for their care and wellbeing.

Is the off-site location in an area away from the effects of a bushfire?

Yes
 No

- Have you considered locations such as community centres, clubs etc. as possible places to go?

Are there amenities (toilets, food, water etc.) available at the off-site location?

Yes
 No

Can the off-site location accommodate the number of occupants?

Yes
 No

- Remember that other persons may wish to utilise the same facility as their shelter for evacuation.
- Accommodation for more than one day may be required.

Does the route to the off-site location require transporting through bushfire affected areas or areas that may be affected by an approaching bushfire?

Yes
 No

- Depending on the extent of the bushfire hazard around the site, the location of a bushfire and the safest route from the site, there may be a need to have two or three off-site locations.

Has the owner of the off-site location advised that they are happy to accommodate occupants if evacuation from a bushfire emergency occurs?

Yes
 No

Determining transport to an off-site location (evacuation)

Part of planning an evacuation is how people are going to be transported to the designated off-site location.

Make arrangements with transport provider/s to have the appropriate vehicles available when required. Make a list of transport providers, contact names and phone numbers and how many vehicles will be available.

The details of the transport provider/s used such as contact name, phone numbers, estimated time for the transport provider/s to arrive and the estimated travelling time to the off-site location should be clearly identified in the BEP.

Consider the following questions to assist planning transport arrangements.

Do you have your own transport for all occupants?

Yes
 No

If **no**, what transport provider will you use?

Are you going to use private vehicles?

Yes
 No

If using private vehicles, will they be available when you need them and will there be drivers available?

Yes
 No

If **no**, what transport provider will you use?

Will there be sufficient vehicles to transport all the occupants?

Yes
 No



Have occupants with support needs been considered when determining transport types and necessary timing to evacuate? Yes No

Is disabled transport required, and is this sufficient to move the number of occupants from the facility? Yes No

Do you require ambulances? Yes No

If **yes**, St John Ambulance Australia needs to be consulted.

Is a community bus available? Yes No

Will community buses be available when you need them and will drivers be available? Yes No

Are other means of transport available? Yes No

Do you need any other type of special transport? Yes No

Once an off-site location and transport arrangements have been identified, identify the estimated time it will take to coordinate occupants and travel to the off-site location.

The time it takes to coordinate and move occupants from the site to another location is the **MINIMUM** time required to evacuate safely. **TAKE THIS INTO CONSIDERATION AND EVACUATE EARLY.**

Step Four: Identify an on-site shelter

An on-site shelter should withstand bushfire attack in the form of smoke, embers, radiant heat and flame contact. An on-site shelter should provide sufficient space for the maximum number of employees and visitors that could be on-site at any given time and should be within easy walking distance from the vulnerable land use, with a designated and sign-posted footpath.

The *ABCB Design and Construction of Community Bushfire Refuges Handbook* (2014) recommends 0.75 m² per person, however it is recommended that a minimum of 1.0 m² per person be considered at a minimum.

On-site shelter in a nominated building

A building proposed to be used as an on-site shelter needs to have a sufficient separation distance from the predominant bushfire prone vegetation, including a safety factor that correlates to the level of risk for the site and the vulnerability of the inhabitants.

The highest level of protection will be achieved when the on-site bushfire shelter is designed by a suitably qualified fire engineer in accordance with the Building Code of Australia and the *ABCB Design and Construction of Community Bushfire Refuges Handbook* (2014).

The on-site bushfire shelter should incorporate an APZ that limits radiant heat exposure to 10 kW/m².

The ongoing maintenance of the building and the surrounding separation distances from the bushfire prone vegetation will be the responsibility of the owner/operator. A 'maintenance plan' should detail the maintenance and annual testing requirements.

On-site shelter in a designated open area

Where a vulnerable land use provides no facilities or built structures that could be utilised for on-site shelter, such as a camping ground, an open space area may be acceptable for on-site shelter, as a last resort. Where an open space area is being proposed, the site and surrounding site vegetation modification and management should seek to achieve a radiant heat flux of 2 kW/m² or less (with an assumed flame temperature of 1200 K). While the separation distances from bushfire prone vegetation to achieve 2 kW/m² are likely to be considerable, some remote coastal camping sites may be able to utilise the beach as an open space area to shelter.

Consideration will need to be given to the anticipated duration of the bushfire event, including the recovery period. Any ability to provide some shelter, such as a roofed area or shielding, would be beneficial. The ongoing maintenance of the separation distances from the bushfire prone vegetation will be the responsibility of the owner/operator.

The following questions will assist the individual developing or reviewing the BEP to identify an on-site building. For an appropriate building, the answers to the below questions should receive a 'yes'.

Is the property well maintained and kept free from a build-up of fuel and leaf litter in gutters and around buildings? Yes No

- Refer to Standards for APZs in Appendix A.2 of the Guidelines.



Is there a building on-site that is away from bushland and is unlikely to be impacted by bushfire?

Yes
 No

- Consider the potential for any adjoining structures, vegetation or combustibles to ignite and impact on the building.
- For facilities where occupants are located in numerous buildings or rooms, it may be appropriate to remain in those rooms under supervision

Is the building constructed in a manner that minimises bushfire attack with appropriate APZs?

Yes
 No

- To determine standards of construction, consult Australian Standard AS 3959 Construction for buildings in bushfire prone areas.

Can the building accommodate the number of occupants and visitors?

Yes
 No

Is there ease of accessibility to the building and is it easily identifiable?

Yes
 No

Is there access to amenities (toilets, food, water etc. away from the effects of a bushfire)?

Yes
 No

D.9 KEY COMPONENTS OF THE BEP

The BEP should contain the following minimum requirements:

1. Facility and occupant details
 - Name and address of facility
 - Contact details (including phone number)

- Number of employees/occupants
 - Number, type and age of occupants
 - Whether the occupants are permanent or transient
 - Whether there is a caretaker on-site
2. Roles and responsibilities of facility personnel and emergency services
 3. Primary and secondary actions (evacuate and shelter-in-place)
 - Location details of primary and secondary actions
 - Procedures for primary and secondary actions
 - Evacuation assembly point(s) and transport arrangements
 4. Procedures and actions
 - Preparedness – actions required prior to and during the bushfire season
 - In response to warnings of a bushfire and as the fire front impacts
 - Recovery – after the bushfire front has passed
 5. Site and location plans
 - Site plan – including assembly points, shelter on-site options
 - Location plan – showing the broader area, evacuation routes and destinations.

D.10 DEVELOP EMERGENCY PROCEDURES AND ACTIONS

Action statements outline the duties and actions required to be undertaken prior to, during and after a bushfire emergency. They state who is to do what and when, such

as who will call the evacuation, ensure all persons are accounted for, coordinating and arranging transport and other requirements.

D.10.1 Preparedness – prior to and during the bushfire season

There are a number of actions that can be undertaken prior to and during the bushfire season to increase the protection of your building and site from a bushfire. This includes simple measures such as maintaining an APZ around the building, clearing gutters and implementing firebreaks in accordance with the local government firebreak notice.

Refer to Addendum 1 for example actions to be undertaken prior to and during the bushfire season. These action statements should be included in the 'Preparedness' section of the BEP template.

Individuals should refer to the **Bushfire Overview** and **My Bushfire Plan** for further information regarding:

- Preparing an emergency kit
- What is bushfire protective clothing
- How to upkeep property to prepare for the bushfire season
- Actively defending a building if it is too late to evacuate.

Awareness and pre-emptive procedures

A BEP may include pre-emptive procedures, such as closing a facility on days of heightened fire weather. Consideration should be given to the development of actions for when the fire danger rating is moderate,



high, extreme, catastrophic, total fire bans or Bureau of Meteorology (BOM) forecasts/warnings. The Department of Fire and Emergency Services website includes information regarding what each fire danger rating means and what individuals should do in response. Pre-emptive procedures should be included in the 'Awareness and Pre-emptive Procedures' section of the BEP.

Actions for how employees keep informed of fire danger ratings, total fire bans and official warnings by emergency services agencies should also be developed. This may be through the DFES website, BOM website, dialling 1996 for Telstra Weather Services and/or local government fire danger rating signs. These should be included in the 'Awareness and Pre-emptive Procedures' section of the BEP. These actions should also include the frequency of when the action should occur. Ensure that the action statements are not too onerous for the responsible persons.

D.11 IN RESPONSE TO WARNINGS OR SIGNS OF A BUSHFIRE AND AS THE FIRE FRONT IMPACTS

D.11.1 Triggers

The action statements should clearly identify certain triggers for evacuation or on-site shelter. A trigger is a timeframe, scenario or some other factor that initiates an emergency procedure action. These should be based on the analysis undertaken to determine the primary and secondary responses, importantly including analysis of the anticipated time to evacuate and the time of arrival of the bushfire.

Triggers to evacuate or on-site shelter should be consistent with the State's emergency services official alert levels and the local emergency management planning set out in the LEMA. The actions and responsible persons for monitoring these triggers should also be outlined in the 'Awareness and Pre-emptive Procedures' section of the BEP.

The key considerations for inclusion in the action statements are:

- Communication, including:
 - procedures for warning and communication
 - procedures for communicating with service providers, off-site facilities and emergency services
 - communications equipment
 - communicating with non-English speaking visitors and residents
- Assembly points and evacuation routes to a designated off-site location(s)
- Routes and assembly to a designated building or area if sheltering on-site
- Accounting for occupants during a bushfire emergency
- Control and coordination of occupants during a bushfire emergency
- Necessary actions in the event of loss of power or water, if sheltering on-site
- Emergency response equipment.

Refer to Addendum 1 for example procedures and actions to be undertaken when evacuating or sheltering on-site during a bushfire emergency.

D.11.2 Recovery – after the bushfire front has passed

It is important to also plan for the actions to be undertaken after a bushfire emergency has taken place and the bushfire front has passed. These actions and the responsible persons should be included in the 'Recovery' section of the BEP.

Refer to Addendum 1 for example actions to be undertaken after a bushfire emergency has taken place.

D.11.3 Site and location plan

A site layout and a separate map displaying the off-site location(s) and primary and secondary evacuation routes to the off-site location(s) should be developed. A site layout is a single sheet diagram of the site that shows the locations of buildings, assembly points and other items such as firefighting equipment. The following features are to be included in the site layout plan, where applicable:

- Site boundaries
- Internal roadways
- Buildings
- Locations of dangerous goods and any other significant hazardous materials
- Emergency vehicular and pedestrian entrances and exits
- Assembly points (for evacuation) and address of off-site location(s)
- Location of on-site buildings or areas for sheltering on-site
- Fire services, such as hydrants, boosters, sprinklers, hose reels, deluge valve stations
- Town mains water supplies and/or on-site water tanks



- Location of electrical supply isolation points
- Location of gas supply locations and isolation valve points
- Indication of current location on the map (e.g. "You are here").

The hard copy site layout and off-site location(s) map should be:

- A3 size
- Provided as an attachment to the BEP
- Laminated or framed and posted in conspicuous locations throughout the facility (in each building)
- Be readily accessible by ALL occupants, visitors and emergency service personnel.

D.12 TRAINING AND EDUCATION

Owners and employees must be trained to develop the skills and knowledge necessary to undertake the duties set out in the BEP.

Employees

- Have a meeting and discuss procedures and who does what.

Other permanent/regular occupants

- Have a community meeting with occupants
- Provide a site layout identifying the designated assembly point(s) and on-site building or area for on-site shelter
- Provide a map of the off-site location(s) (for evacuation) and evacuation routes.

Temporary occupants

- Have information flyers available during the bushfire season outlining emergency management procedures and bushfire protection measures
- Have a site layout with the designated assembly point(s) and on-site building or area for on-site shelter and separate map of the off-site location(s) for evacuation posted in each room.

A responsible person/s of the facility such as the owner, operator or manager should ensure that delivery of education and training for employees and occupants occurs and to conduct annual exercises on these procedures.

The training should address the following:

- duties of employees as described in the BEP
- procedures contained in the BEP, including the decision to evacuate or on-site shelter, evacuation routes and off-site location(s) and specific transportation arrangements
- responding to alarms and reports of a bushfire emergency
- communication during a bushfire emergency
- human behaviour during emergencies
- the performance of the building and its installations during a bushfire
- where to find official emergency information. For example, Emergency WA website, 13 DFES information line, local ABC Radio.

It is recommended that drills are practised once prior to and during the bushfire season to ensure everyone understands their role in an emergency.

Critical drill exercises should include testing the arrangements and procedures for the:

- decision to evacuate or on-site shelter
- location of the evacuation routes and off-site location(s)
- bushfire action statements, including who has responsibility for what
- transport and accommodation arrangements.

Actions for undertaking training and education should be included in the 'Preparedness' section of the BEP.

Refer to:

- AS 3745-2010 – Planning for emergencies in facilities.



ADDENDUM 1 – EXAMPLE TRIGGERS AND ACTIONS TO BE UNDERTAKEN BEFORE, DURING AND AFTER A BUSHFIRE EMERGENCY

The following are examples of triggers and actions to be undertaken before, during and after a bushfire emergency, which may or may not be relevant to the facility. Ensure that actions included in the BEP are not too challenging for occupants of the facility.

GENERAL TRIGGERS THAT MAY REQUIRE AN EMERGENCY RESPONSE AND ACTION STATEMENT

- 'Advice', 'Watch and Act' or 'Emergency Warning' alert from the DFES or DBCA
- An 'extreme' or 'catastrophic' fire danger rating and/or a total fire ban
- Direction to evacuate or to shelter-in-place from an emergency service authority
- Prevented from evacuation due to road closure or other hindrances
- Fire in close proximity and considered too dangerous to leave
- Smoke or fire has been identified in the area.

ACTION STATEMENTS JUST PRIOR AND DURING THE BUSHFIRE SEASON

- Review BEP to ensure details, procedures and contact phone numbers are correct
- Ensure employees and other occupants are informed and familiar with the procedures laid out in the BEP
- Place current version of site layout in facility in visible location(s)
- Ensure the nominated on-site buildings or areas and off-site location and routes to both are still a safe option
- Ensure first aid kits, fire extinguishers, emergency lighting and other emergency resources are current, serviceable and accessible
- Have a fire engineer and/or Bushfire Planning Practitioner undertake an annual audit, including testing, of any building identified as an on-site shelter
- Ensure adequate levels of drinking water are available in the designated on-site building
- Contact off-site location(s) for potential use during a bushfire emergency
- Contact transport suppliers for potential use during a bushfire emergency
- Ensure property access is kept clear and easily trafficable
- Ensure an emergency evacuation kit has been prepared and is easily accessible by staff
- Ensure on-site vegetation, including APZs, lawns and grassed areas, comply with the requirements of the local government's annual firebreak and fuel load

notice issued under section 33 of the *Bush Fires Act 1954*, and any requirements identified within the BMP and/or the BEP

- Undertake a general clean-up of the site to remove any obvious hazards that could contribute to increased fire intensity. This could include wood piles, rubbish piles, location of gas or other flammable cylinders, roof and gutters.

ONGOING ACTIONS DURING THE BUSHFIRE SEASON:

- Maintain APZs around all buildings and ensure lawns and grassed areas are kept below 10cm in height
- Maintain compliance with the local government's annual firebreak and fuel load notice
- Ensure defensible spaces around buildings and assembly points are maintained
- Keep records of staff and visitors
- Update contact details of the emergency management team and employees.

To maintain situational awareness and to be prepared for a possible bushfire approaching, employees may follow the procedures outlined below:

- Maintain situational awareness through a range of information sources, including local ABC Radio, the Emergency WA website ([emergency.wa.gov.au](https://www.emergency.wa.gov.au)), DFES Facebook or Twitter, 13 DFES (13 33 37) information line and local emergency services
- Look outside for any signs of smoke or fire in the area
- Staff to carry two-way radio and spare battery and ensure that they are charged



- Inform occupants of the fire situation
- Ensure that the person in charge (such as the Chief Warden) has a mobile phone and is contactable
- Advise the local government Chief Bushfire Control Officer or Community Emergency Services Manager that the centre is operating and that it will need to be advised early in the event of an evacuation being necessary
- Maintain arrangements for transportation (for evacuation).

In the event of an approaching bushfire threatening the facility, employees and other occupants of the facility may follow the procedures outlined below:

Evacuation

- The fire warden (or person responsible) is to advise 13 DFES (13 33 37) or '000' that the facility's occupants are evacuating (include how many people and where they are going)
- Arrange for vehicles to meet at the designated assembly point for pick-up of occupants
- Contact off-site location and inform them of pending arrival
- Move all persons to the assembly point for evacuation
- Ensure all persons are accounted for prior to departure (use list of occupants and visitors)
- Ensure all site buildings have all doors and windows closed prior to leaving the site
- At the designated off-site location, move all persons inside and ensure all persons are accounted for and safe

- The fire warden (or person responsible) is to advise the local emergency service that all persons have been evacuated and are accounted for and safe at the designated off-site location
- Maintain situational awareness through a range of information sources, including local ABC Radio, the Emergency WA website ([emergency.wa.gov.au](https://www.emergency.wa.gov.au)), DFES Facebook or Twitter, 13 DFES (13 33 37) information line and local emergency services.

Shelter-in-place

- Designated fire warden will take control of the situation
- Ensure all doors and windows within the facility are closed
- Move all persons to the designated on-site building or area
- Ensure all persons are accounted for (use list of occupants and visitors register).
- The fire warden (or person responsible) is to call '000' for assistance and advise 13 DFES (include phone number) that the facility's occupants are sheltering-in-place (include how many people and which building on-site)
- Prepare to actively defend, including readying hoses and other equipment
- Two persons to make regular exterior visual inspection (wearing appropriate protective clothing from bushfire) of the on-site building for embers and extinguish where possible (to action only if appropriate protective clothing is available)

- Maintain situational awareness through a range of information sources including local ABC Radio, the Emergency WA website ([emergency.wa.gov.au](https://www.emergency.wa.gov.au)), DFES Facebook or Twitter, 13 DFES (13 33 37) information line and local emergency services.

Action statements after the bushfire threat has passed

- Ensure the safety of all people and seek medical assistance for those requiring it
- No person should re-enter any evacuated building until it is deemed safe to do so
- Follow the directions of emergency services personnel at all times
- The fire warden (or person responsible) to arrange the movement of occupants back to the site and/or their separate accommodation
- All occupants are to be accounted for on their return
- Checking the [Australian Red Cross 'Register, Find, Reunite' service](#).
- Inform the police/emergency services of the return of persons to the facility
- Review the BEP for effectiveness, make note of weaknesses and amend as necessary.