



Department of Planning,
Lands and Heritage

ACTIVE
IN FORCE



Residential Design Codes

Volume 2

2024



DESIGN
WA For a
Better Built
Environment

The Department of Planning, Lands and Heritage acknowledges the traditional owners and custodians of this land. We pay our respect to Elders past and present, their descendants who are with us today, and those who will follow in their footsteps.

Acknowledgment

This document has been influenced by content from the NSW Apartment Design Guide as a well-established and tested exemplar of contemporary planning and design policy for apartment development. The Western Australian Planning Commission gratefully acknowledges the support and assistance of the NSW Government Department of Planning and Environment in the development of this policy.

Disclaimer

This document has been produced by the Department of Planning, Lands and Heritage on behalf of the Western Australian Planning Commission. Any representation, statement, opinion or advice expressed or implied in this publication is made in good faith and on the basis that the Government, its employees and agents are not liable for any damage or loss whatsoever which may occur as a result of action taken or not taken, as the case may be, in respect of any representation, statement, opinion or advice referred to herein. Professional advice should be obtained before applying the information contained in this document to particular circumstances.

© State of Western Australia

Published by the
Western Australian Planning Commission

Gordon Stephenson House
140 William Street
Perth WA 6000
Locked Bag 2506
Perth WA 6001

Version 4 published 10 April 2024

website:www.dplh.wa.gov.au

email:info@dplh.wa.gov.au

tel: 08 6551 8002

fax: 08 6551 9001

National Relay Service: 13 36 77

The Department of Planning, Lands and Heritage owns all photography in this document unless marked (PC) in caption and listed in photography credits.

This document is available in alternative formats on application to the Department of Planning, Lands and Heritage Communications branch at media.dplh.wa.gov.au.

Residential Design Codes

Volume 2

About this document

▶ Planning reform

Previous planning reform identified the need for initiatives and actions to improve design and **development**, now being delivered as Design WA. Stage 1 delivered elements with a direct planning reform mandate, including:

- State Planning Policy 7.0 *Design of the Built Environment*
- *Residential Design Codes Volume 2* (this policy)
- Design Review Guide

The *Action Plan for Planning Reform* further expands upon this by updating *Residential Design Codes Volume 1* to provide improved **development** outcomes for medium density development. Consequential modifications to Volume 2 (this policy) have been undertaken to facilitate this.

▶ About good design

Good design is not a subjective idea; it can be defined and measured. Notions of design quality extend beyond taste, style and appearance to encompass functionality, **sustainability**, response to context, structural integrity, flexibility in use, and cost efficiency, both during construction and over the life of the **building**. Most importantly, good design results in an environment that performs well for all users and the broader community.¹

Good design endeavours to reconcile multiple concurrent and often competing objectives, and outcomes vary according to the circumstances of each **site** and project. The logic and rigour of the design process of a project may be more important than whether it meets predefined outcomes. This needs to be acknowledged in the conventions and methods for guidance, discussion and evaluation of design in the planning system.

¹ State Planning Policy 7.0 *Design of the Built Environment*

▶ Planning for design

Planning is often focussed on compliance with specific standards and metrics, and measures proposals against quantitative standards. There are limits to the effectiveness of these prescriptive controls in achieving good design outcomes, especially for complex and **site-specific developments**. Performance-based controls apply qualitative performance criteria to evaluate proposals against desired outcomes and planning objectives. Design review processes can help facilitate performance evaluation to inform statutory planning.

▶ Who is this document for?

The purpose of the Residential Design Codes is to provide a comprehensive basis for the control of residential **development** throughout Western Australia.

This Volume (R-Codes Volume 2 - Apartments) provides planning and design standards for residential **apartments (multiple dwellings)** in high density coded areas (R80 and above and R-AC). This also includes any dwellings, within a **mixed use development** in these areas.

The policy also:

- Guides developers, planners, urban designers, architects, landscape architects, builders and other professionals when designing apartments and preparing an application for development approval.
- Assists planning professionals in local and State government with strategic planning and in the preparation of local controls, design guidelines and the assessment of development proposals.
- Informs the community on the principles of good design and planning practice for the development of residential apartments.

For **multiple dwelling** developments in low and medium density coded areas (R10-R60), refer to Volume 1 of the R-Codes.

► Document structure

1

Introduction

Part 1 establishes the purpose and application of this policy. The **Ten design principles** of State Planning Policy 7.0 *Design of the Built Environment* are set out as overarching principles.

2

Primary controls

Part 2 provides the Primary Controls that relate to R-Codings with guidance and discussion for local governments seeking to vary the Primary Controls of this policy to suit local context through their **local planning frameworks**.

3

Siting the building

Part 3 sets out key considerations for the siting of **apartments**. It includes analysis and response to **site** context, interface with neighbours and the **public domain**, and measures to achieve quality **open spaces** and maximise residential **amenity**. It is to be used by all parties designing, submitting or assessing **development** proposals.

4

Designing the building

Part 4 informs the design and assessment of **apartment** projects to ensure apartments deliver high **amenity** for residents. It includes **building** form, layout, functionality, **landscape** design, environmental performance and residential amenity. It is to be used by all parties designing, submitting or assessing **development** proposals.

A

Appendices

Appendices include guidance for information required at different stages in the planning process.

➤ Arrangement of Parts 2, 3 and 4

Parts 2, 3 and 4 are presented as a series of design elements, each dealing with a different aspect of **building** siting and design.

Each design element includes the following sections to inform assessment of applications for **development** approval:

- A statement of **Intent** for each element that explains the intended outcome and why it is important
- **Element Objectives** that define the intended outcome for the element
- **Acceptable Outcomes** that are specific measures and outcomes to assist in meeting the Element Objectives
- Guidance including matters to be considered and design responses that can achieve the Objectives:
 - in Part 2 the **Planning Guidance** is for local governments in preparing modifications to the Primary Controls through the **local planning framework** to respond to **local character** and contexts
 - in Parts 3 and 4 the **Design Guidance** is for designers and development assessors

➤ Performance-based policy

This is a performance-based policy. Applications for **development** approval need to demonstrate that the design achieves the objectives of each design element. While addressing the Acceptable Outcomes is likely to achieve the Objectives, they are not a deemed-to-comply pathway and the proposal will be assessed in context of the entire design solution to ensure the Objectives are achieved. Proposals may also satisfy the Objectives via alternative means or solutions.

➤ Graphic layout

Element Objectives and Acceptable Outcomes are always contained in the coloured and grey boxes. Design Guidance usually follows either on the same page or the following page.

Part 2

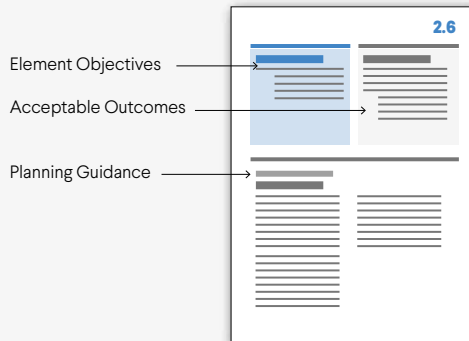

Part 2 provides default Primary Controls that apply where no local settings are in place. The Planning Guidance in Part 2 helps local governments set built-form controls through their **local planning framework**.

Parts 3 & 4

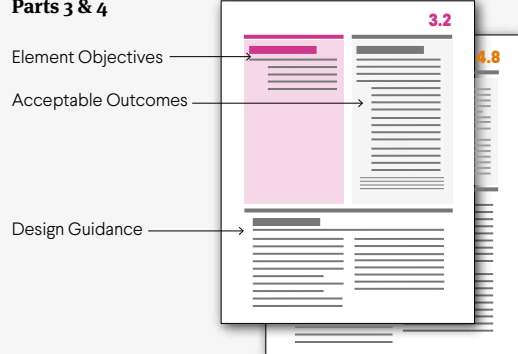

Parts 3 and 4 provide Element Objectives, Acceptable Outcomes and Design Guidance for the siting, design and **amenity of apartment development**. These settings assist proponents, design reviewers and decision-makers in making and assessing proposals.

► Applying an example

4.3

Size and layout of dwellings

ELEMENT OBJECTIVES

Development is to achieve the following Element Objectives:

EO 4.3.1 The internal size and layout of dwellings is functional with the ability to flexibly accommodate furniture settings and personal goods, appropriate to the expected household size.

EO 4.3.2 Ceiling heights and room dimensions provide for well-proportioned spaces that facilitate good natural ventilation and daylight access.

ACCEPTABLE OUTCOMES

Acceptable Outcomes are likely to assist in satisfying the objectives but are not a comprehensive 'steered-to-comply' list. In order to achieve the Element Objectives, proposals may require additional and/or alternative design solutions in response to the site conditions, streetscape and design approach.

A 4.3.1 Dwellings have a minimum internal floor area in accordance with Table 4.3a.

A 4.3.2 Habitable rooms have minimum floor areas and dimensions in accordance with Table 4.3b.

A 4.3.3 Measured from the finished floor level to finished ceiling level, minimum ceiling heights are:

- Habitable rooms – 2.7m
- Non-habitable rooms – 2.4m

All other ceilings meet or exceed the requirements of the NCC.

A 4.3.4 The length of a single aspect open plan living area is equal to or less than 3 x the ceiling height. An additional 1.5m length may be provided for a kitchen, where the kitchen is the furthest point from the window in an open plan living area provided that the maximum length does not exceed 9m.

Table 4.3a Minimum floor areas for dwelling types

Dwelling type	Minimum internal floor area
Studio	37m ²
1 bed	47m ²
2 bed* 1 bath*	67m ²
3 bed* 1 bath*	90m ²

* An additional 2m² shall be provided for designs that include a second or separate toilet, and 5m² for designs that include a second bathroom.

Table 4.3b Minimum floor areas and dimensions for habitable rooms

Habitable room type	Minimum internal floor area	Minimum internal dimension
Master bedroom	10m ²	3m ²
Other bedrooms	9m ²	3m ²
Living room – studio and 1 bed apartments	N/A	3.6m
Living room – other dwelling types	N/A	4m

* Excluding robes

4.3

Size and layout of dwellings

DESIGN GUIDANCE

Potential alternative solutions to satisfy the Element Objectives will be considered on a performance basis.

DG 4.3.1 People living in apartments need spaces that support their lifestyles, with rooms to spend time with family and friends, rooms to seek time alone, and a range of functional spaces for cooking, cleaning, washing and storage. Consider layouts that are flexible to accommodate the diverse and changing needs of occupants, including:

- room sizes and dimensions that can accommodate a variety of furniture arrangements, for example, rectangular spaces are often more easily furnished than square spaces
- prepare design drawings that illustrate potential furniture layouts using realistically sized furniture, including living and dining settings in the living space
- arranging internal spaces to maximise flexibility and privacy for individual occupants
- dual-master apartments or dual key apartments to provide more flexibility for different household configurations
- locating living areas and bedrooms on the external face of the building to receive daylight, with living spaces oriented towards views
- providing space for robes, typically with a minimum width of 1.8m for the main bedroom and 1.5m for other bedrooms.

DG 4.3.2 Efficiency of space can be enhanced by co-locating internal circulation areas to maximise the useable area of rooms and improve privacy between different functional areas. Give careful consideration to the location of doors, windows and walls available for furnishing as well as the relationships between different functional spaces. For example, avoid direct access between bedrooms and bathroom via the living room as such access compromises the privacy of these spaces, increases noise transfer and limits the functionality of the living space.

DG 4.3.3 Consider the size and proportions of rooms to create a sense of spaciousness and maximise daylight penetration. For instance, long, narrow rooms in cross-over or cross-through apartments require a width of at least 4m.

DG 4.3.4 Additional ceiling height adds significantly to the sense of space in a dwelling. Higher ceilings may also assist with natural ventilation and to accommodate ceiling fans for cooling and heat distribution. Given that the overall building height is constrained once constructed, provision for additional ceiling height needs to be considered at the planning stage. When choosing ceiling heights, consider:

- introducing changes in ceiling height to give greater definition to spaces within the dwelling
- locating bulkheads above non-habitable spaces such as robes or storage areas, to maintain higher ceilings in habitable space areas
- providing more ceiling height to ground floor street front units to provide greater flexibility for adaptive reuse, for instance if located in mixed use areas, consider providing ceiling heights of 3.3m or more
- if ceiling heights are constrained, reducing room depth accordingly to compensate for the loss of daylight penetration, reduced volume and sense of spaciousness.

Step 1: Understand Element Objectives

The proponent should first look at the Element Objectives that apply to each element. Each Element Objective must be addressed either through demonstration of the Acceptable Outcomes **OR** through alternative means such as the considerations and options outlined in the Design Guidance.

For 4.3 *Size and layout of dwellings*, Element Objective 4.3.1 states the expectation for the **apartment** layout to support functionality and **amenity** but does not presuppose a particular solution.

Option A: Follow Acceptable Outcomes

In this example, adopting standard apartment sizes listed in the Acceptable Outcomes should satisfy the Element Objective, however if the **apartment** is poorly planned such that it is not functional and/or has poor **amenity** it may not satisfy the Element Objective, regardless of size.

Option B: Apply Performance Solution

On the other hand, proposals that do **not** meet the sizes outlined in the Acceptable Outcome but can demonstrate a functional, amenable **apartment** may be assessed as meeting the Element Objective. Design Guidance is provided to suggest alternative solutions that may satisfy the Element Objectives. In the case of apartment size and layout the Design Guidance provides some considerations for ensuring that smaller apartments are functional and offer high **amenity** for residents.

For Option A and B, the onus is on the proponent to demonstrate that the Element Objective is achieved. In the above example, that the **apartments** are functional and have good **amenity**.

4.3

ELEMENT OBJECTIVES

Development is to achieve the following Element Objectives:

EO 4.3.1 The internal size and layout of dwellings is functional with the ability to flexibly accommodate furniture settings and personal goods, appropriate to the expected household size.

EO 4.3.2 Ceiling heights and room dimensions provide for well-proportioned spaces that facilitate good natural ventilation and daylight access.

ACCEPTABLE OUTCOMES

Acceptable Outcomes are likely to assist in satisfying the objectives but are not a comprehensive 'steered-to-comply' list. In order to achieve the Element Objectives, proposals may require additional and/or alternative design solutions in response to the site conditions, streetscape and design approach.

A 4.3.1 Dwellings have a minimum internal floor area in accordance with Table 4.3a.

A 4.3.2 Habitable rooms have minimum floor areas and dimensions in accordance with Table 4.3b.

A 4.3.3 Measured from the finished floor level to finished ceiling level, minimum ceiling heights are:

- Habitable rooms – 2.7m
- Non-habitable rooms – 2.4m

All other ceilings meet or exceed the requirements of the NCC.

A 4.3.4 The length of a single aspect open plan living area is equal to or less than 3 x the ceiling height. An additional 1.5m length may be provided for a kitchen, where the kitchen is the furthest point from the window in an open plan living area provided that the maximum length does not exceed 9m.

Table 4.3a Minimum floor areas for dwelling types

Dwelling type	Minimum internal floor area
Studio	37m ²
1 bed	47m ²
2 bed* 1 bath*	67m ²
3 bed* 1 bath*	90m ²

* An additional 2m² shall be provided for designs that include a second or separate toilet, and 5m² for designs that include a second bathroom.

Table 4.3b Minimum floor areas and dimensions for habitable rooms

Habitable room type	Minimum internal floor area	Minimum internal dimension
Master bedroom	10m ²	3m ²
Other bedrooms	9m ²	3m ²
Living room – studio and 1 bed apartments	N/A	3.6m
Living room – other dwelling types	N/A	4m

* Excluding robes

4.3

DESIGN GUIDANCE

Potential alternative solutions to satisfy the Element Objectives will be considered on a performance basis.

DG 4.3.1 People living in apartments need spaces that support their lifestyles, with rooms to spend time with family and friends, rooms to seek time alone, and a range of functional spaces for cooking, cleaning, washing and storage. Consider layouts that are flexible to accommodate the diverse and changing needs of occupants, including:

- room sizes and dimensions that can accommodate a variety of furniture arrangements, for example, rectangular spaces are often more easily furnished than square spaces
- prepare design drawings that illustrate potential furniture layouts using realistically sized furniture, including living and dining settings in the living space
- arranging internal spaces to maximise flexibility and privacy for individual occupants
- dual-master apartments or dual key apartments to provide more flexibility for different household configurations
- locating living areas and bedrooms on the external face of the building to receive daylight, with living spaces oriented towards views
- providing space for robes, typically with a minimum width of 1.8m for the main bedroom and 1.5m for other bedrooms.

DG 4.3.2 Efficiency of space can be enhanced by co-locating internal circulation areas to maximise the useable area of rooms and improve privacy between different functional areas. Give careful consideration to the location of doors, windows and walls available for furnishing as well as the relationships between different functional spaces. For example, avoid direct access between bedrooms and bathroom via the living room as such access compromises the privacy of these spaces, increases noise transfer and limits the functionality of the living space.

DG 4.3.3 Consider the size and proportions of rooms to create a sense of spaciousness and maximise daylight penetration. For instance, long, narrow rooms in cross-over or cross-through apartments require a width of at least 4m.

DG 4.3.4 Additional ceiling height adds significantly to the sense of space in a dwelling. Higher ceilings may also assist with natural ventilation and to accommodate ceiling fans for cooling and heat distribution. Given that the overall building height is constrained once constructed, provision for additional ceiling height needs to be considered at the planning stage. When choosing ceiling heights, consider:

- introducing changes in ceiling height to give greater definition to spaces within the dwelling
- locating bulkheads above non-habitable spaces such as robes or storage areas, to maintain higher ceilings in habitable space areas
- providing more ceiling height to ground floor street front units to provide greater flexibility for adaptive reuse, for instance if located in mixed use areas, consider providing ceiling heights of 3.3m or more
- if ceiling heights are constrained, reducing room depth accordingly to compensate for the loss of daylight penetration, reduced volume and sense of spaciousness.

Contents

ABOUT THIS DOCUMENT

PART 1

II INTRODUCTION

1.1 Preliminary	2
1.2 Local planning framework	4
1.3 Design review and approval processes ..	6
1.4 Ten design principles.....	8

PART 2

1 PRIMARY CONTROLS

10

2.1 Primary controls	12
2.2 Building height.....	16
2.3 Street setbacks.....	18
2.4 Side and rear setbacks	20
2.5 Plot ratio	22
2.6 Building depth	24
2.7 Building separation.....	26
2.8 Development incentives for community benefit	28

PART 3

SITING THE DEVELOPMENT	30
3.1 Site analysis and design response	32
3.2 Orientation.....	34
3.3 Tree canopy and deep soil areas.....	36
3.4 Communal open space.....	40
3.5 Visual privacy	44
3.6 Public domain interface.....	46
3.7 Pedestrian access and entries	50
3.8 Vehicle Access	52
3.9 Car and bicycle parking	54

PART 4

DESIGNING THE BUILDING	58
4.1 Solar and daylight access.....	60
4.2 Natural ventilation.....	64
4.3 Size and layout of dwellings.....	68
4.4 Private open space and balconies.....	72
4.5 Circulation and common spaces.....	76
4.6 Storage.....	80
4.7 Managing the impact of noise.....	82
4.8 Dwelling mix.....	86
4.9 Universal design.....	88
4.10 Façade design.....	90
4.11 Roof design	92
4.12 Landscape design	94
4.13 Adaptive reuse	98
4.14 Mixed use.....	100
4.15 Energy efficiency	104
4.16 Water management and conservation	106
4.17 Waste management	108
4.18 Utilities.....	110

APPENDICES

APPENDICES	112
A1 – Ten design principles table	114
A2 – Streetscape character types.....	116
A3 – Site analysis and design response guidance.....	118
A4 – Design development guidance.....	121
A5 – Development application guidance	122
A6 – Objectives summary	124
A7 – Explanatory figures	128
Definitions	132
Photo credits.....	138

Introduction

This introduction provides an overview of the statutory purpose and application of the Residential Design Codes Volume 2.

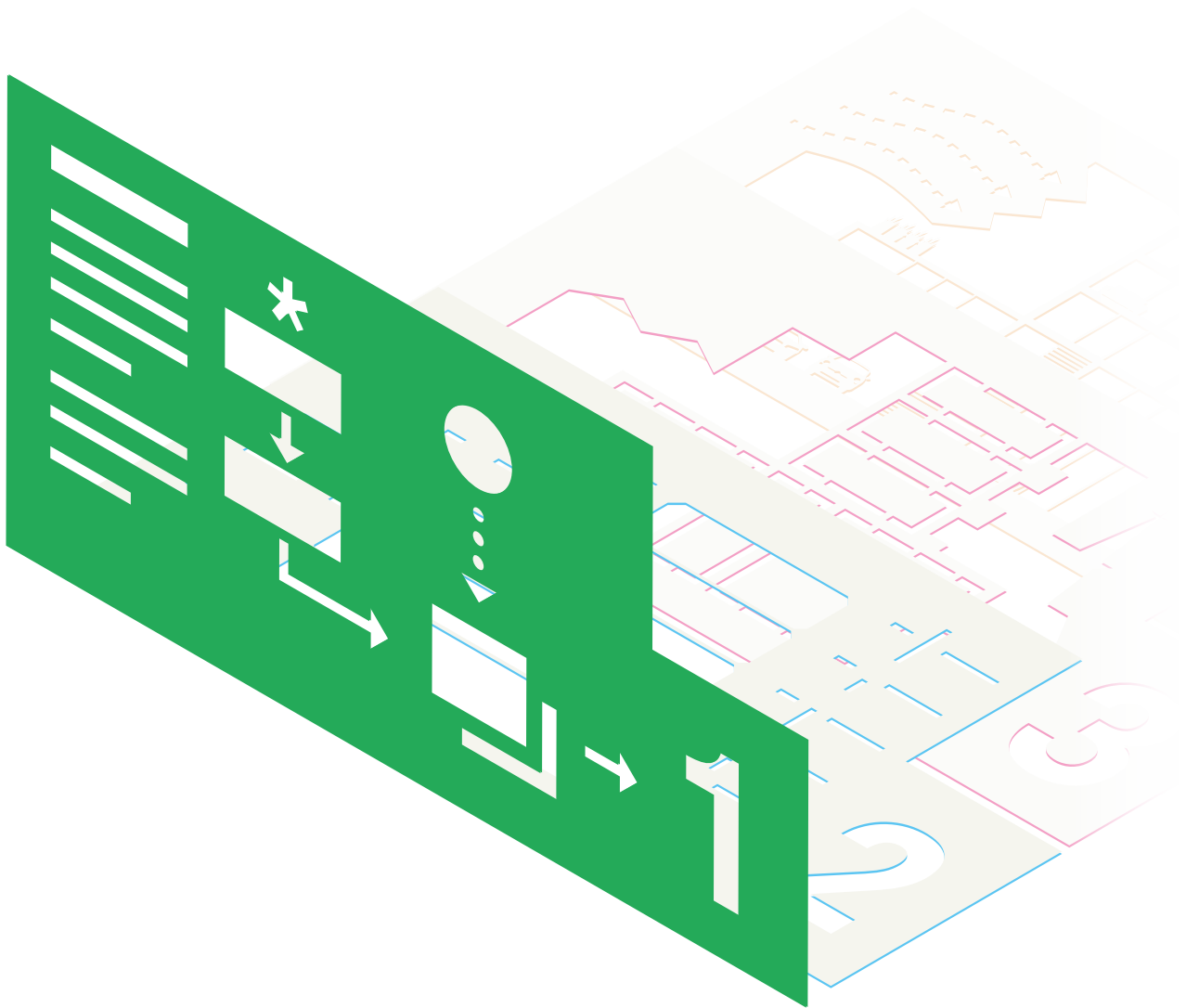



1.1	PRELIMINARY	2
1.2	LOCAL PLANNING FRAMEWORK	4
1.3	DESIGN REVIEW AND APPROVAL PROCESSES	6
1.4	TEN DESIGN PRINCIPLES	8

Preliminary

➤ Citation

This Planning Code is made under Part 3A of the *Planning and Development Act 2005* and is cited as Residential Design Codes Volume 2 (R-Codes Vol.2).

Purpose

The purpose of the Residential Design Codes is to provide a comprehensive basis for the control of residential **development** throughout Western Australia.

➤ Policy objectives

Policy objectives for **multiple dwellings** are:

- to provide residential **development** of an appropriate design for the intended residential purpose, land tenure, density, place context and scheme objectives
- to encourage design consideration of the social, environmental and economic opportunities possible from new housing, and an appropriate response to local context
- to encourage design that considers and respects local **heritage** and culture
- to facilitate residential development that offers future residents the opportunities for better living choices and affordability when seeking a home, as well as reduced operational costs and security of investment in the long term.

Policy objectives for the planning, governance and **development** process:

- to encourage design that is **responsive to site**, size and geometry of the **development site**
- to allow variety and diversity of housing choices where it can be demonstrated this better reflects context or scheme objectives
- to ensure clear scope for scheme objectives to influence the assessment of proposals
- to ensure certainty in timely assessment and determination of proposals, applied consistently across State and local government.

◆ Application of policy objectives

In assessing applications for **development** approval against the R-Codes Vol.2, the decision-maker shall have regard to the above policy objectives, Element Objectives provided in Parts 2, 3 and 4 of the R-Codes Vol.2 and objectives provided within the applicable **local planning framework**.

◆ Application of the Residential Design Codes

The R-Codes apply to all **residential development** throughout Western Australia.

The R-Codes are divided into two volumes. R-Codes Volume 1 applies to all **single house** and **grouped dwelling developments**; and **multiple dwelling development** in areas coded R10 to R60. R-Codes Volume 2 applies to multiple dwelling (apartment) developments in areas coded R80 and above and R-AC. Any **dwellings** in a **mixed use development** are considered to be **multiple dwellings** and the relevant volume applies.

Local planning framework

The decision-maker shall not amend or modify the R-Codes unless such modification relates to matters expressly permitted under the R-Codes to be amended or modified.

Subject to clauses 1.2.2 and 1.2.3, a **local planning policy, local development plan or precinct structure plan** that affects residential **development** shall be consistent with the provisions of the R-Codes Volume 2 and may provide local objectives for housing design and development in so far as it guides the consideration of the decision-maker to judge proposals.

For the **local planning policy, local development plan, or precinct structure plan** to have effect, it should be available with the scheme where the decision-maker makes the scheme available.

Local governments are encouraged to:

- maximise consistency of the **local planning framework** with this policy
- review pre-existing local planning framework instruments where inconsistent with this policy
- consider the need for settings that respond to a specific need related to a locality or region, where this is consistent with the Element Objectives of this policy.

◆ 1.2.1 Pre-existing local planning policies

If a properly adopted **local planning policy** which came into effect prior to the gazettal of the R-Codes is inconsistent with the R-Codes Volume 2:

(a) For those sections identified in clause 1.2.2, the provisions of the R-Codes Volume 2 do not supersede any **development** standard provided in the local planning policy

(b) For the sections of Parts 3 and 4 identified in clause 1.2.3, the provisions of the R-Codes Volume 2 prevail over the local planning policy to the extent of the inconsistency.

◆ 1.2.2 Sections that may be amended or replaced by local government

Where consistent with the Element Objectives, local governments may prepare and adopt **local planning policies** and **local development plans** that amend or replace the Acceptable Outcomes of the following sections of the R-Codes Volume 2:

- All of Part 2
- 3.6 *Public domain interface*
- 3.7 *Pedestrian access and entries*
- 3.8 *Vehicle access*
- 4.10 *Façade design*
- 4.11 *Roof design*
- 4.13 *Adaptive reuse*

Note: Section 3.1 *Site analysis and design response* contains Design Guidance only.

◆ 1.2.3 Sections that may be amended or replaced with WAPC Approval

Notwithstanding clause 1.2.1, local government may with the approval of the **WAPC** prepare **local planning policies, local development plans** and **precinct structure plans** that amend or replace any of the Acceptable Outcomes of the following sections of the R-Codes Volume 2:

- 3.2 *Orientation*
- 3.3 *Tree canopy and deep soil areas*
- 3.4 *Communal open space*
- 3.5 *Visual privacy*
- 3.9 *Car and bicycle parking*
- 4.1 *Solar and daylight access*
- 4.2 *Natural ventilation*
- 4.3 *Size and layout of dwellings*
- 4.4 *Private open space and balconies*
- 4.5 *Circulation and common spaces*
- 4.6 *Storage*
- 4.7 *Managing the impact of noise*
- 4.8 *Dwelling mix*
- 4.9 *Universal design*
- 4.12 *Landscape design*
- 4.14 *Mixed use*
- 4.15 *Energy efficiency*
- 4.16 *Water management and conservation*
- 4.17 *Waste management*
- 4.18 *Utilities*

where it can be demonstrated to the satisfaction of the WAPC that the proposed amendment or replacement:

- is warranted due to a specific need related to that particular locality or region;
- is consistent with the Element Objectives of the R-Codes Volume 2; and
- can be properly implemented and audited by the decision-maker as part of the ongoing **building** approval process.

◆ 1.2.4

Notwithstanding clauses 1.2.2 and 1.2.3, local government may, with the approval of the **WAPC**, prepare **local planning policies, local development plans** and **precinct structure plans** to augment the R-Codes Volume 2 with Objectives to guide judgement about the merits of proposals relating to any aspect of **apartment development** that is not provided for under the R-Codes Volume 2 and is required within the local context.

Design review and approval processes

Apartment developments are complex proposals that benefit from early and systematic design consideration.

1. **Concept design** is where proponents start to work on a concept for their development. Plans are usually unresolved sketches with basic drawings and **plot ratio** calculations. For complex proposals, proponents may seek advice from the local government as to desirable design outcomes for the site and locality.

Appendix A3 *Site analysis and design response guidance* outlines information that is useful to inform these initial discussions.

2. In the **design development** phase, proponents respond to feedback and analysis of the concept design to develop a more detailed proposal. Pre-lodgement and/or design review processes can be very useful at this stage to obtain feedback on the proposed design.

Appendix A4 *Design development guidance* provides useful guidance on matters that may be included at this stage, noting that not all elements will be resolved.

3. The requirements for **development application** materials are detailed in the *Planning and Development (Local Planning Scheme Regulations) 2015*.

Additional materials that will support consideration of a proposal in accordance with this policy are outlined at Appendix A5 *Development application guidance* and A6 *Objectives summary* which lists all Element Objectives from Parts 2, 3 and 4 of this document.

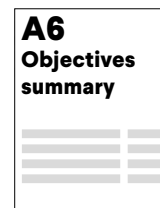
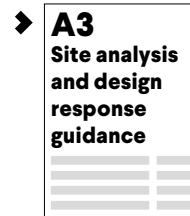

Figure 1.3a The guidance provided in the Appendices is available to assist your design process with local government design review.

◆ Design review

Design review is the process of evaluating the design quality of a proposal with the first review often occurring prior to lodgement of the application. It is carried out by appropriately-trained, multi-disciplinary built environment experts, who are experienced in offering objective and constructive design advice.

R-Codes Vol.2 is performance-based, which means there is no deemed-to-comply pathway and Element Objectives may be met in a variety of ways as relevant to the intent, the **site** and context, and the nature of the projects. The approach is intended to prevent poor design outcomes that are driven by prescriptive requirements and to encourage creative and innovative design responses.

More information about design review can be found in State Planning Policy 7.0 *Design of the Built Environment*, the *Design Review Guide* or by talking to the relevant local government.



Photo 1.3a & b A local Design Review Panel in process.

Ten design principles

State Planning Policy 7.0 *Design of the Built Environment* (SPP 7.0) establishes **Ten design principles** that underpin the Policy Objectives and the Element Objectives in Parts 3 and 4. Appendix A1 *Ten design principles table* shows the relationship between the Ten design principles and the elements of Part 3 and 4. The Ten design principles inform the design, review and decision-making processes for all **development** under this policy.

The SPP 7.0 **Ten design principles** are listed here for reference.



1. Context and character

Good design responds to and enhances the distinctive characteristics of a local area, contributing to a **sense of place**.

2. Landscape quality

Good design recognises that together **landscape** and **buildings** operate as an integrated and sustainable system, within a broader ecological context.

3. Built form and scale

Good design ensures that the massing and height of **development** is appropriate to its setting and successfully negotiates between existing built form and the intended future character of the local area.

4. Functionality and build quality

Good design meets the needs of users efficiently and effectively, balancing functional requirements to perform well and deliver optimum benefit over the full life-cycle.

5. Sustainability

Good design optimises the **sustainability** of the built environment, delivering positive environmental, social and economic outcomes.

6. Amenity

Good design provides successful places that offer a variety of uses and activities while optimising internal and external **amenity** for occupants, visitors and neighbours, providing environments that are comfortable, productive and healthy.

7. Legibility

Good design results in **buildings** and places that are legible, with clear connections and easily identifiable elements to help people find their way around.

8. Safety

Good design optimises safety and security, minimising the risk of personal harm and supporting safe behaviour and use.

9. Community

Good design responds to local community needs as well as the wider social context, providing **buildings** and spaces that support a diverse range of people and facilitate social interaction.

10. Aesthetics

Good design is the product of a skilled, judicious design process that results in attractive and inviting **buildings** and places that engage the senses.

Primary Controls

Part 2 provides the primary controls that relate to R-Codings and also includes guidance and discussion for local governments seeking to vary the primary controls of this policy to suit local context through their local planning frameworks.

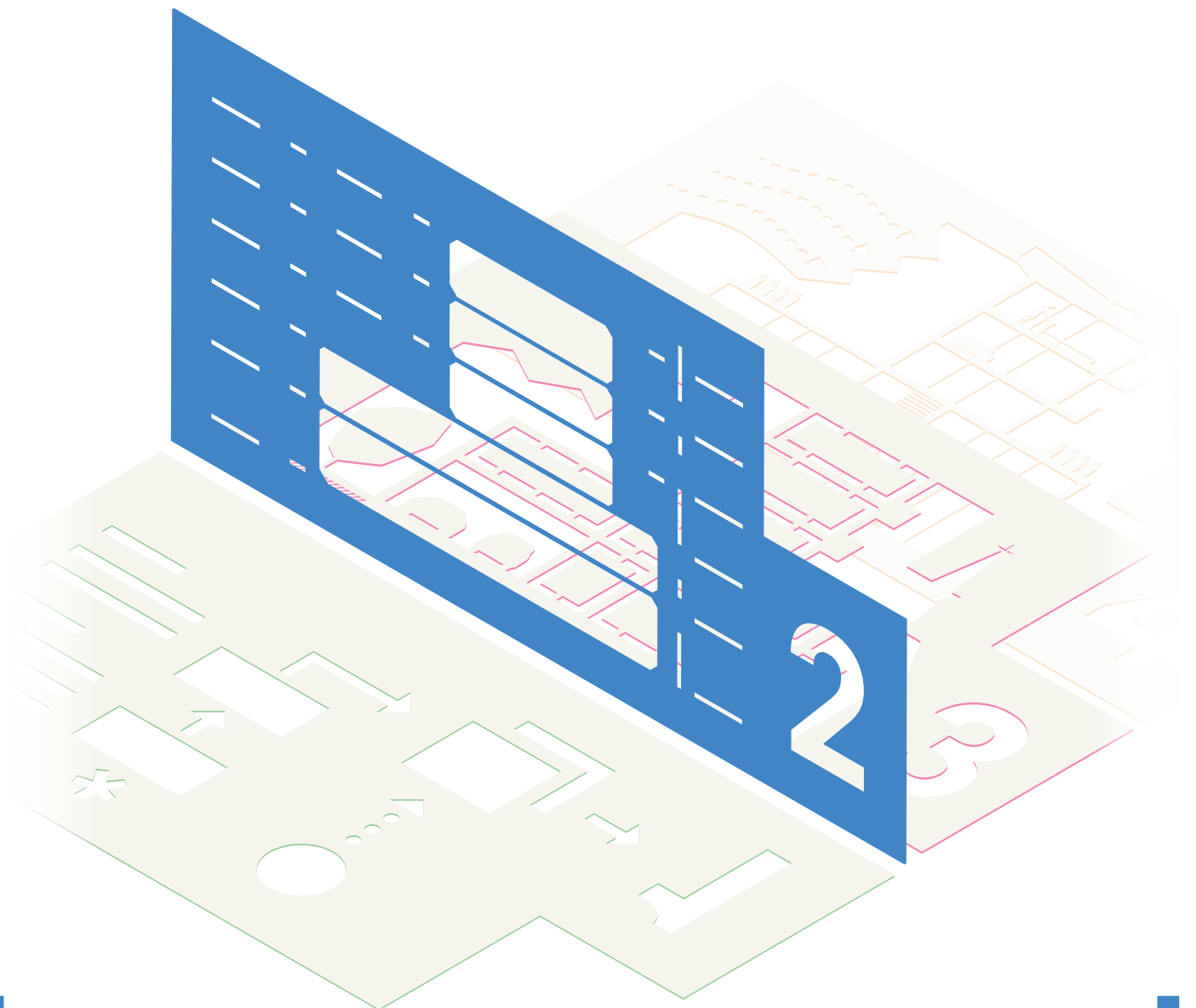

2

2.1	PRIMARY CONTROLS	12
2.2	BUILDING HEIGHT	16
2.3	STREET SETBACKS	18
2.4	SIDE AND REAR SETBACKS	20
2.5	PLOT RATIO	22
2.6	BUILDING DEPTH	24
2.7	BUILDING SEPARATION	26
2.8	DEVELOPMENT INCENTIVES FOR COMMUNITY BENEFIT	28

Primary controls

➤ Intent

Primary controls manage the form and scale of new **development** appropriate to the context and the existing or planned character of an area, while moderating impacts on neighbouring properties.

The Primary Controls in this policy are organised in two groups:

1. **Building envelope** controls establish a three-dimensional boundary within which **development** may occur, defined through combination of:

- **building height** (refer 2.2)
- **street setbacks** (refer 2.3)
- side and rear setbacks (refer 2.4)

The building envelope establishes the maximum extent of development allocated to a **site** as a three-dimensional volume – the ‘container’ within which development may occur. Building envelopes, alongside other controls, manage the scale and impact of a development, having regard for the existing and proposed **streetscape** character, prevailing **lot** sizes, adjacent built form, natural features and significant views.

The building envelope represents the limits of development in terms of height and setbacks but does not represent the maximum development potential of a site which is further constrained by **building massing** controls as described below.

2. **Building massing** controls are the combined effect of the arrangement, volume and shape of a building or group of buildings. They apply to the bulk and arrangement of built form within the building envelope, governed by:

- **plot ratio** (refer 2.5)
- **building depth** (refer 2.6)
- building separation (refer 2.7)

The way a building is arranged on its site is particularly important for larger buildings. Site size and geometry, topography and configuration in relation to adjacent **streets, open space** and other buildings are important considerations.

Massing is also a significant factor in passive heating, cooling and daylighting, with successful massing using the shape and size of the building to optimise climatic performance and reduce energy demand.

Element Objectives for each Primary Control are provided in the following sections 2.2 – 2.7. The Primary Controls Table (refer Table 2.1) sets out the default Acceptable Outcomes for building height, street and boundary setbacks and plot ratio under this policy.



Figure 2.1a The final built form will usually differ significantly from the building envelope, due to plot ratio constraint as well as necessary articulation of building for light, ventilation, open spaces and circulation.

2.1.1 Setting the local planning framework

Good design responds and contributes to the context and character of the area as defined by social, economic and environmental characteristics as well as natural and built features.

The Primary Controls in this policy are informed by neighbourhood character types that describe the context and character of different neighbourhoods, centres and precincts. The six neighbourhood character types are illustrated at Appendix A2. Local governments should identify the context and character of neighbourhoods and precincts via strategic planning processes and in consultation with the community, industry and other key stakeholders. **Apartment** design should respond appropriately to the defined neighbourhood context and character.

Where required, the Primary Controls may be calibrated by local government to suit local conditions and to provide certainty to applicants, decision-makers and the community in the preparation and assessment of **development** proposals. Part 2 (specifically 2.2 to 2.7) of this policy assists local governments preparing **local planning framework** instruments which amend or replace the Primary Controls. It suggests appropriate tools and controls, as well as the rationale behind their usage, organised into simple categories relating to context and intended development intensity.

Context

Context is defined by the broader environment within which the **development** occurs, with a focus on transport, land uses, economic activity, local services and open space as well as demographics and socio-economic factors. The existing, and changing, context of a locality is therefore a significant consideration in determining what housing types are required and where they should be located. Locations that have high accessibility to jobs, services and open space are generally more suited to higher density residential development, however all areas will have requirements for housing choice and diversity in response to community needs.

Defining the context also establishes the parameters for individual development and how new **buildings** can respond to the attributes and needs of an area.

Precinct and centre planning for the restructuring of land and land uses in areas undergoing extensive change requires careful consideration of context to determine the desired outcomes in terms of land use mix, open space and **landscape**, community facilities and transport, as well as housing mix.

Character

Character is an important aspect of **local identity** created through the combined effect of:

- the height, scale, **setback**, style and condition of existing **buildings**
- land uses and **street** based activity
- the physical form of the street including width and function, verges and footpaths
- **landscaping** of the public and private realms.

Understanding character is essential to define an appropriate style, scale and form for new **development** that retains and enhances character in an existing area or contributes to the desired character in a renewing area.

A desired character should be determined in the precinct planning process for new or major redevelopment areas. Cues can be taken from the context and character of surrounding areas to determine a street grid and hierarchy and **lot** sizes, building typologies and **building envelopes** that together will create the desired suburban or urban character. This policy includes useful benchmarks and guidance to inform this strategic planning process.

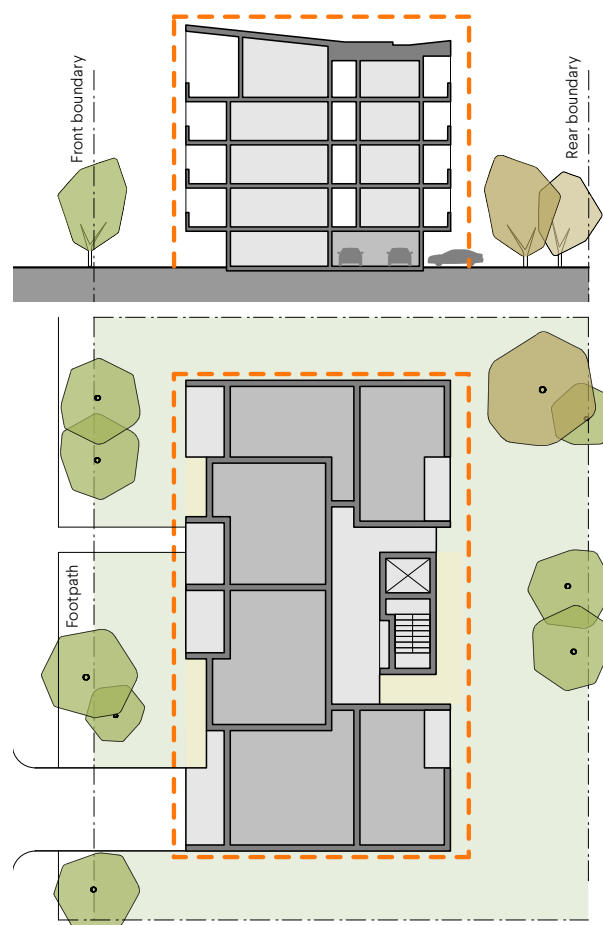

Figure 2.1b Building envelopes define the 'container' within which a building is designed. They are used to understand the future urban form and scale of an area, but should be understood not to equate to the built outcome.

Primary controls table

Table 2.1 (opposite page) provides default **development** standards and does not supersede any development standard provided by a **local planning scheme, local planning policy, precinct structure plan or local development plan** (refer 1.2 *Local planning framework*).

In the absence of properly adopted local instruments, Table 2.1 applies.

Table 2.1 summarises Acceptable Outcomes for elements 2.2, 2.3, 2.4 and 2.5. Refer to the following pages for supporting content.

Table 2.1 Primary controls table

Streetscape contexts and character <i>refer A2</i>	Applies to R-Code areas, default settings apply unless alternative provisions defined in local planning instruments			Applicable where designated by local government in local planning scheme, precinct structure plan, local development plan, local planning policy				
	Medium-rise	Higher density residential		Neighbourhood centre	Mid-rise urban centres	High density urban centres		Planned areas
Site R-Coding	R80	R100	R160	R-AC4	R-AC3	R-AC2	R-AC1	R-AC0
Building height (storeys) <i>refer 2.2</i>	4	4	5	3	6	7	9	Refer to local planning scheme, local dev plan and/or precinct controls as applicable
Boundary wall height (storeys) ^{1,2} <i>refer 2.4</i>	2 ³	2 ³		2	3	4		
Minimum primary and secondary street setbacks <i>refer 2.3</i>	2m	2m		2m or Nil ⁵	2m or Nil ⁵	2m or Nil ⁵		
Minimum side setbacks ⁶ <i>refer 2.4</i>	3m	3m		Nil				
Minimum rear setback <i>refer 2.4</i>	3m	6m		6m	Nil	Nil		
Average side setback where building length exceeds 16m <i>refer 2.4</i>	3.5m	3.5m	4.0m	NA	NA	NA		
Plot ratio ⁷ <i>refer 2.5</i>	1.0	1.3	2.0	1.2	2.0	2.5	3.0	
Notes	¹ Wall may be built up to a lot boundary , where it abuts an existing or simultaneously constructed wall of equal or greater proportions ² Where the subject site and an affected adjoining site are subject to different density codes, the length and height of any boundary wall on the boundary between them is determined by reference to the lower density code ³ Boundary wall only permitted on one boundary, and shall not exceed 2/3 length. ⁵ Nil setback applicable if commercial use at ground floor ⁶ Boundary setbacks will also be determined by provisions for building separation and visual privacy within this SPP and building separation provisions of the NCC . ⁷ Refer to Definitions for calculation of plot ratio							

Building height

➤ Intent

The apparent height of new **development** shall be appropriate to the **streetscape** and desired character of the area and shall not adversely impact the **amenity** of adjoining properties. **Building height** is one of the factors that define **building envelopes**. In this policy it is expressed in **storeys** relative to **natural ground level**. Building height limits guide the intended scale of streetscapes and manage impacts between development and neighbours in terms of **solar access**, wind, and visual privacy.

Default building height limits for all development covered under this policy are defined by the Primary Controls in Table 2.1. Table 2.1 also includes provisions and guidance for boundary wall height limits to moderate the most direct effect of height on neighbours.

Height limits may be varied through local planning instruments in response to **local character** and context. Applicants must therefore address height provisions in applicable local planning instruments, where these differ to the default requirements of Table 2.1.

Related Elements

- 4.1 Solar and daylight access
- 4.11 Roof design

Table 2.2 Indicative building height

Storeys	Indicative overall building height in metres
2	9
3	12
4	15
5	18
6	21
7	24
8	27
9	30
10	33

- Overall building heights are set by adding together the floor to ceiling heights for the desired number of storeys, with a nominal allowance of 4m for the ground floor and 3m for subsequent floors. Add at least 2m to the total to allow for rooftop articulation.

- Building height limits for higher density typologies: These default heights are provided as a conservative baseline and higher building height limits may be appropriate subject to detailed local planning.

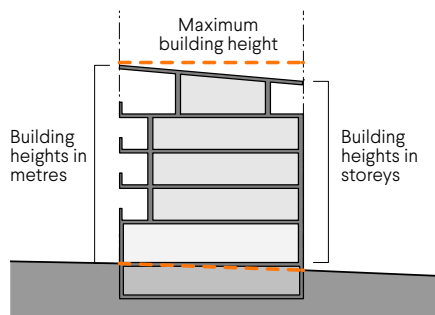

Figure 2.2a The total height of a building informs the number of storeys possible in a development. Floor to ceiling heights vary depending on the use. Shops and offices are typically higher than residential apartments.

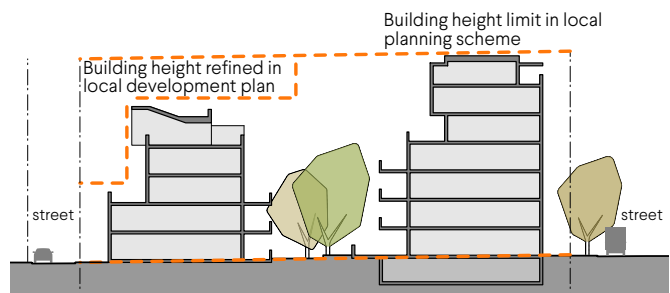

Figure 2.2b Building height should reflect the existing or desired future character of an area. The diagram shows how height controls can be locally modified to respond to the desired characteristics of respective streetscapes.

ELEMENT OBJECTIVES

Development is to achieve the following Element Objectives:

- O 2.2.1** The height of **development** responds to the desired future scale and character of the **street** and local area, including existing **buildings** that are unlikely to change.
- O 2.2.2** The height of **buildings** within a **development** responds to changes in topography.
- O 2.2.3** **Development** incorporates articulated roof design and/or roof top **communal open space** where appropriate.
- O 2.2.4** The height of **development** recognises the need for **daylight** and **solar access** to adjoining and nearby residential development, **communal open space** and in some cases, public spaces.

ACCEPTABLE OUTCOMES

In Part 2 only, Acceptable Outcomes are default provisions to assist in satisfying the objectives. In order to achieve the Element Objectives, proposals may require additional and/or alternative design solutions in response to the site conditions, streetscape and design approach where specified in the local planning framework (clause 1.2).

- A 2.2.1** **Development** complies with the **building** height limit (**storeys**) set out in Table 2.1, except where modified by the **local planning framework**, in which case development complies with the building height limit set out in the applicable local planning instrument.

CONSIDERATIONS FOR LOCAL GOVERNMENTS

PLANNING GUIDANCE

The height of new **development** often dominates discussions about planning; however, it is not always the main factor impacting on neighbourhoods. Well-designed taller **buildings** with good siting, **setbacks**, **open space** and articulation can be significantly better for neighbourhoods than poorly-designed low-rise buildings with high **site** coverage and no consideration of context.

The following guidance can assist local governments to determine appropriate height settings.

- PG 2.2.1** Local governments should articulate their values and approach to **building** height settings.
- PG 2.2.2** **Building** heights should typically be expressed in **storeys** to allow flexibility of design solutions at ground and roof levels, promote generous floor to ceiling heights and provide for future building adaptability.
- PG 2.2.3** When applying **storey**-based **building** height limits, Table 2.2 shows indicative building height in metres that would normally correlate to number of storeys, with typical allowances for ceiling heights, floor structure, services, rooftop articulation and topographic changes. Double-height floors should be counted as two storeys.
- PG 2.2.4** **Site**-specific **building envelopes** and heights can be developed within a **precinct structure plan** or a **local development plan** for large or complex sites such as those on steep slopes and those with variable topography.
- PG 2.2.5** Ensure that **building** height controls respond to the desired number of **storeys**, the minimum floor to floor heights required for **adaptive reuse** and include generous ground floor heights.
- PG 2.2.6** Ensure the maximum **building** height allows for architectural roof features such as articulated roof planes, and/or the provision of **communal open space** at the roof top.
- PG 2.2.7** Where rooftop **open space** is desired, ensure adequate maximum height is provided and consider secondary height controls for lift/stair access and shade structures.
- PG 2.2.8** When adjusting height controls, test in tandem with **plot ratio** to ensure the settings are well aligned.
- PG 2.2.9** It may be appropriate to determine heights by relating them to features within the existing **streetscape** or locality such as topography or **heritage** elements. This may include:
 - defining an overall height or **street** wall heights to key **datum lines**, such as eaves, **parapets**, **cornices** or spires
 - aligning floor to floor heights of new **development** with existing built form.
- PG 2.2.10** Consider secondary height controls to transition built form, for example:
 - a **street** wall height to define the scale and enclosure of the street
 - a step down in **building** height at the boundary between two height zones.
- PG 2.2.11** Take into account the viability of **development** types and efficient use of land when setting height controls. The **NCC** has certain requirements based on the effective height of a **building**, such as fire protection systems, fire resistance and vertical transportation. When setting height controls, consider these thresholds as they impact on the feasibility of a development.

Street setbacks

► Intent

The **setback** of the **building** from the **street** shall be planned to complement the **streetscape** character and to provide residents with a distinct sense of address, arrival and privacy as appropriate.

The street setback is one of the factors that define the **building envelope**. It is expressed as a minimum distance in metres between the building and the cadastral **street boundary**, and in the case of **sites** with two street **frontages**, includes the **secondary street**. Depending on the intended streetscape, setbacks may include public pavement, hard or **soft landscape** treatment (including **deep soil areas**) or private gardens.

Default street setbacks for all **development** covered under this policy are defined by the Primary Controls in Table 2.1. Local governments may amend, replace or augment the settings for street setbacks through the **local planning framework**, to suit the local context and intended development outcome, to promote a particular streetscape character and to respond to site-specific conditions. Applicants must therefore address street setback provisions contained within applicable local planning instruments where these differ to the default requirements of Table 2.1.

Related Elements

- 3.2 Orientation
- 3.5 Visual privacy
- 3.6 Public domain interface
- 3.8 Vehicle access
- 3.9 Car and bicycle parking
- 4.14 Mixed use

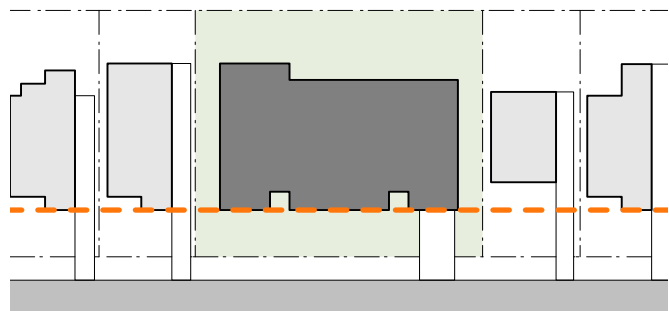

Predominant setback

Figure 2.3a, b & c Street setbacks should be consistent with existing setback patterns in the street or setbacks that achieve the desired future character of the area.

ELEMENT OBJECTIVES

Development is to achieve the following Element Objectives:

- O 2.3.1** The **setback** of the **development** from the **street** reinforces and/or complements the existing or proposed **landscape character** of the street.
- O 2.3.2** The **street setback** provides a clear transition between the public and private realm.
- O 2.3.3** The **street setback** assists in achieving visual privacy to **apartments** from the street.
- O 2.3.4** The **setback** of the **development** enables **passive surveillance** and outlook to the **street**.

ACCEPTABLE OUTCOMES

In Part 2 only, Acceptable Outcomes are default provisions to assist in satisfying the objectives. In order to achieve the Element Objectives, proposals may require additional and/or alternative design solutions in response to the site conditions, streetscape and design approach where specified in the local planning framework (clause 1.2).

- A 2.3.1** Development complies with the **street setback** set out in Table 2.1, except where modified by the **local planning framework**, in which case development complies with the street setback set out in the applicable local planning instrument.

CONSIDERATIONS FOR LOCAL GOVERNMENTS PLANNING GUIDANCE

Setting **street setbacks** for **buildings** should begin with consideration of the desired **streetscape** character. The proportions of a street are established by the distance between building **frontages** in combination with the height of buildings, with this aspect of streetscape character directly affecting how the street will be perceived and used.

- PG 2.3.1** Determine **street setback** controls relative to the desired **streetscape** and **building** forms, for example:
 - define a future streetscape in a transitional area
 - match existing **development**
 - appropriate setbacks to maintain views and curtilage to special buildings
 - retain significant trees
 - consider parameters for articulation of building **frontage** through **balconies, landscaping, porticos, awnings** etc. where these elements are included in the street setback
 - use a setback range where the desired character is for variation within overall consistency, or where **lot boundaries** are at an angle to the street.
- PG 2.3.2** Consider nominating a maximum percentage of **development** that may be built to the **street setback** (where one is set) to ensure modulated **building frontages**.
- PG 2.3.3** Identify the quality, type and use of **open space** and **landscaped** areas facing the **street** so **setbacks** can accommodate landscaping and **private open space**.
- PG 2.3.4** In conjunction with height controls, consider **street setbacks** for upper levels to:
 - reinforce the desired scale of **buildings** at street level
 - reduce overshadowing of the street and other buildings.

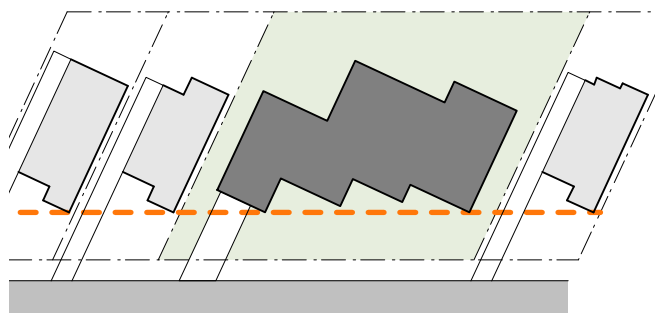

Variation for angled subdivision

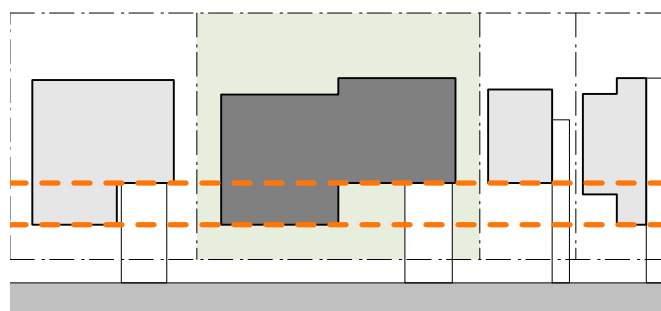

Setback range

Side and rear setbacks

► Intent

Respecting the shared boundary is fundamental to being a 'good neighbour'. The relationship of built form to the property boundary must be carefully considered to balance the needs of new **development** with maintaining the **amenity** of adjacent **sites**.

The side and rear **setbacks** are factors that define **building envelopes** expressed as a minimum distance in metres between the **building** and the cadastral site boundary. Side and rear setback areas can also moderate the extent of built form so that useable land can be provided for **open space, courtyards, driveways**, stormwater runoff management, tree planting and **landscaping**.

Default side and rear setbacks for all development covered under this policy are defined by the Primary Controls in Table 2.1. Table 2.1 also includes provisions and guidance for the height and length of boundary walls to moderate the impact on neighbours.

Local governments may make variations to settings for side and rear setbacks through the **local planning framework**, to suit the local context and intended development outcome. Local planning may define specific setback provisions to promote particular **streetscapes** or respond to site-specific conditions. Applicants must therefore address setback provisions in applicable local planning instruments, where these differ to the default requirements of Table 2.1.

Related Elements

- 2.7 Building separation
- 3.2 Orientation
- 3.3 Tree canopy and deep soil areas
- 3.5 Visual privacy
- 3.6 Public domain interface
- 4.1 Solar and daylight access
- 4.2 Natural ventilation

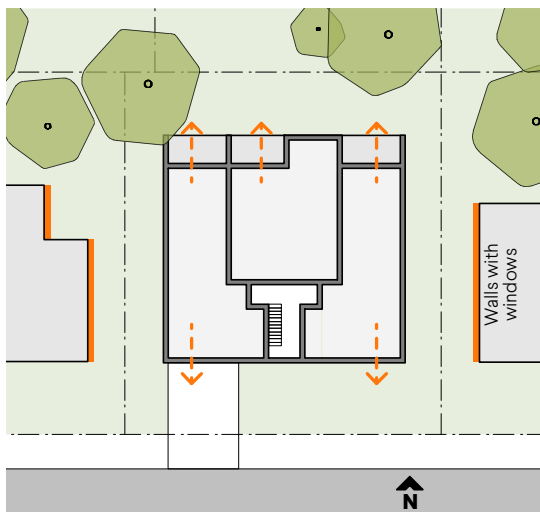

Figure 2.4a On infill sites follow the existing open space patterns, limit side setbacks and locate habitable rooms to face the street and rear boundary to optimise amenity and privacy for all.

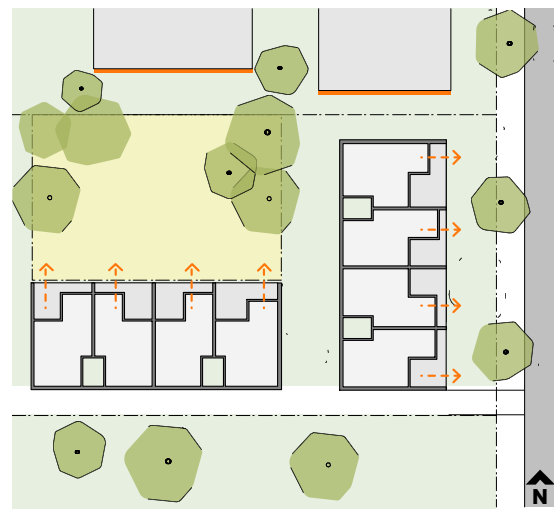

Figure 2.4b On sites with solar access to the north consider larger setbacks and locating the open space for northern orientation of units.

ELEMENT OBJECTIVES

Development is to achieve the following Element Objectives:

- O 2.4.1** Building boundary **setbacks** provide for adequate separation between neighbouring properties.
- O 2.4.2** Building boundary **setbacks** are consistent with the existing **streetscape** pattern or the desired streetscape character.
- O 2.4.3** The **setback** of **development** from side and rear boundaries enables retention of existing trees and provision of **deep soil areas** that reinforce the **landscape character** of the area, support tree canopy and assist with **stormwater** management.
- O 2.4.4** The **setback** of **development** from side and rear boundaries provides a transition between **sites** with different land uses or intensity of development.

ACCEPTABLE OUTCOMES

In Part 2 only, Acceptable Outcomes are default provisions to assist in satisfying the objectives. In order to achieve the Element Objectives, proposals may require additional and/or alternative design solutions in response to the site conditions, streetscape and design approach where specified in the local planning framework (clause 1.2).

- A 2.4.1** Development complies with the side and rear **setbacks** set out in Table 2.1, except where:
 - (a)** modified by the **local planning framework**, in which case development complies with the side and rear setbacks set out in the applicable local planning instrument
 - AND /OR**
 - (b)** a greater setback is required to address 3.5 *Visual privacy*.
- A 2.4.2** Development is **setback** from the boundary in order to achieve the Objectives outlined in 2.7 *Building separation*, 3.3 *Tree canopy and deep soil areas*, 3.5 *Visual privacy* and 4.1 *Solar and daylight access*.

CONSIDERATIONS FOR LOCAL GOVERNMENTS PLANNING GUIDANCE

- PG 2.4.1** Test side and rear **setbacks** with height controls to understand the potential for overshadowing of the **site**, adjoining properties and **open space**.
- PG 2.4.2** In existing areas test side and rear **setbacks** with the requirements for visual privacy, tree retention and other known characteristics of the locality.
- PG 2.4.3** Consider nil side **setbacks** where the desired **streetscape** character is for continuous **development**, such as in dense urban areas, main **streets** or for **podiums** within centres.
- PG 2.4.4** Table 2.1 makes provision for some section of build-to-boundary **development** in **streetscapes** that largely comprise detached development. Consider whether the extent of this development is appropriate, or whether additional build-to-boundary may be permitted without detrimental effect on neighbours or the streetscape to improve efficiency and flexibility of ground floor layouts. Consider the appropriate settings for particular streetscapes or neighbourhoods.
- PG 2.4.5** In **streetscapes** that largely contain build-to-boundary (attached) **development** consider whether constraints for nil-**setback** boundary walls are appropriate.
- PG 2.4.6** On **sloping sites**, consider increasing side and rear **setbacks** where new **development** is uphill to minimise overshadowing and assist with visual privacy.

Plot ratio

↳ Intent

Plot ratio is the method of establishing an allowable volume of **development** within the 'container' of the **building envelope**. It is the ratio of the gross **plot ratio area** of a building expressed relative to the **site area** and sets the **building massing** for a **development site**. This allowable volume of built form can be deployed with flexibility within the building envelope to respond to contextual and orientation factors.

The **plot ratio area** includes the total area of all **dwelling**s and commercial spaces but excludes the area of some circulation and **service areas** (see definitions for full explanation). Refer to Table 2.1 for default plot ratio provisions.

Local governments may make variations to plot ratio through the **local planning framework**, to suit the local context and intended development outcome. Applicants must therefore address plot ratio provisions in applicable local planning instruments, where these differ to the default requirements of Table 2.1.

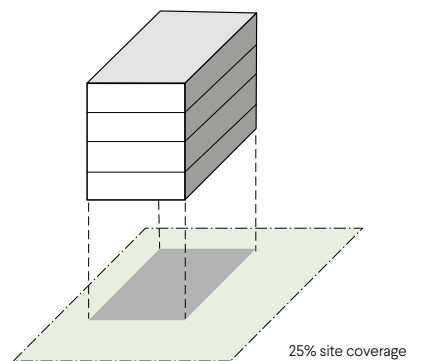
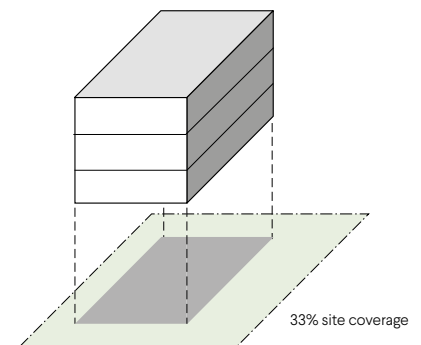
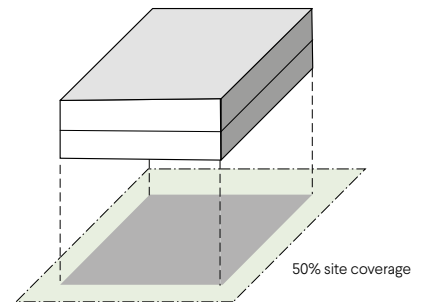

Figure 2.5a Indicative different built form massing for apartment buildings with a Plot Ratio factor of 1.0.

ELEMENT OBJECTIVES

Development is to achieve the following Element Objective:

- O 2.5.1** The overall bulk and scale of **development** is appropriate for the existing or planned character of the area.

ACCEPTABLE OUTCOMES

In Part 2 only, Acceptable Outcomes are default provisions to assist in satisfying the objectives. In order to achieve the Element Objectives, proposals may require additional and/or alternative design solutions in response to the site conditions, streetscape and design approach where specified in the local planning framework (clause 1.2).

- A 2.5.1** **Development** complies with the **plot ratio** requirements set out in Table 2.1, except where modified by the **local planning framework**, in which case development complies with the plot ratio set out in the applicable local planning instrument.

CONSIDERATIONS FOR LOCAL GOVERNMENTS PLANNING GUIDANCE

- PG 2.5.1** Test the desired built form outcome against the proposed **plot ratio** to ensure it is coordinated with the **building envelope**, height, **depth**, **setbacks** and other **site** requirements. The allowable **plot ratio area** should fit comfortably within the building envelope, as the envelope also needs to account for **building** elements and **service areas** that are not included in plot ratio area, and to allow for building articulation.
- PG 2.5.2** Consider how **plot ratio** is applied across larger **sites**. A single plot ratio across an entire precinct may result in under or over **development**. For example, in an area with a consistent height control:
- corner, mid-block or wide shallow sites tend to have different floor space capacities
 - small sites with a single **building** may have greater floor space capacity than larger sites with multiple buildings
 - large sites with multiple buildings require greater space between buildings and may have less floor space capacity.
- PG 2.5.3** Where both residential and non-residential uses are permitted, develop **plot ratio** controls that consider the distinct plot ratio definitions and requirements for each use. Allow for services, circulation, car park and loading requirements.
- PG 2.5.4** Residential **plot ratio** tends to be lower compared with non-residential plot ratio. This is because residential **buildings** are typically less deep than commercial buildings to provide higher levels of internal **amenity** and to incorporate elements such as **balconies**.

Building depth

➤ Intent

The overall depth of **buildings** affects building performance and resident **amenity**, particularly **solar access** and ventilation. Buildings of excessive length or depth can also impact **streetscape**. Smaller **building depths** generally deliver better outcomes with regard to these factors. Together with **plot ratio** and building separation (refer 2.5 *Plot ratio*, 2.7 *Building separation*), building depth is one of the factors that govern **building massing** within the **building envelope**.

The depth of mixed use buildings typically transition from being deeper at lower levels, where commercial and retail uses are accommodated, to narrower at upper levels, where residential use warrants higher levels of internal amenity and outlook.

Local planning may define alternative building depth provisions to promote particular built form patterns. Applicants must therefore address building depth provisions in applicable local planning instruments, where these differ to the Acceptable Outcome.

Related Elements

- 4.1 *Solar and daylight access*
- 4.2 *Natural ventilation*

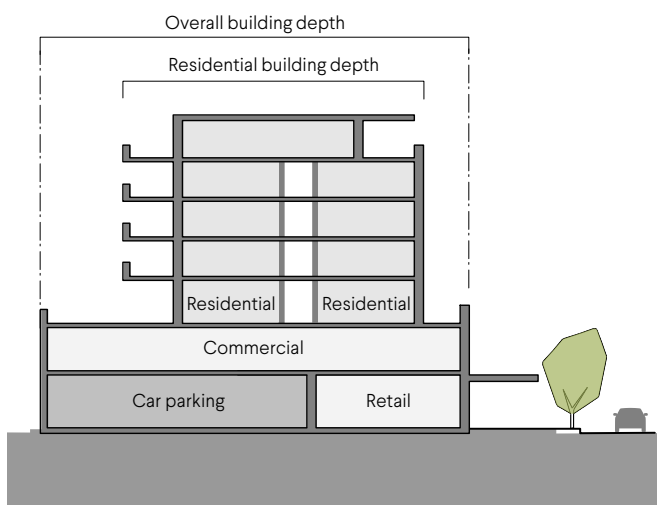

Figure 2.6a A mixed use building showing the transition of building depth: deeper floors on lower levels dedicated to retail/commercial uses and narrower residential apartments on upper levels.

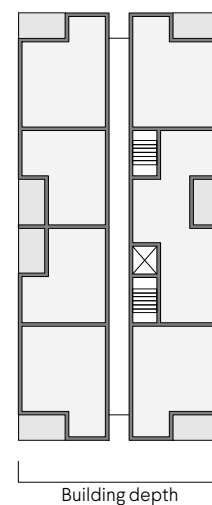

Figure 2.6b Measuring building depth.

ELEMENT OBJECTIVES

Development is to achieve the following Element Objectives:

- O 2.6.1** Building depth supports apartment layouts that optimise daylight and solar access and natural ventilation.
- O 2.6.2** Articulation of building form to allow adequate access to daylight and natural ventilation where greater building depths are proposed.
- O 2.6.3** Room depths and/or ceiling heights optimise daylight and solar access and natural ventilation.

ACCEPTABLE OUTCOMES

In Part 2 only, Acceptable Outcomes are default provisions to assist in satisfying the objectives. In order to achieve the Element Objectives, proposals may require additional and/or alternative design solutions in response to the site conditions, streetscape and design approach where specified in the local planning framework (clause 1.2).

- A 2.6.1** Developments that comprise single aspect apartments on each side of a central circulation corridor shall have a maximum building depth of 20m. All other proposals will be assessed on their merits with particular consideration to 4.1 Solar and daylight access and 4.2 Natural ventilation.

CONSIDERATIONS FOR LOCAL GOVERNMENTS

PLANNING GUIDANCE

- PG 2.6.1** Test building depths against indicative floor plan and apartment layouts to ensure natural ventilation and daylighting requirements can be satisfied within the proposed depth.
- PG 2.6.2** Site constraints may require varied building depths to achieve good levels of residential amenity for residents and neighbours.
- PG 2.6.3** Consider varying building depth relative to building orientation. For example, buildings facing east-west capture sun from both aspects and may have apartments of up to 20m wide (if dual aspect), while buildings facing north-south should be narrower to reduce the number of south facing apartments that have limited or no direct sunlight access (refer 4.1 Solar and daylight access).
- PG 2.6.4** Where greater building depth is proposed, demonstrate that indicative layouts achieve acceptable natural ventilation and daylighting requirements. This may require additional building articulation.
- PG 2.6.5** Coordinate building height and building depth:
 - buildings that have smaller depths over a greater height deliver better residential amenity than those with greater depth and a lower height
 - greater building depths may be possible where higher ceiling heights are provided, for example adaptive reuse of an existing building or apartments with an internal mezzanine floor where a portion has a double-height ceiling.
- PG 2.6.6** For mixed use buildings, align building depth to the likely future uses. For example, transition deeper commercial or retail podium levels to a narrower residential tower above.
- PG 2.6.7** Set the depth control in metres. The building depth includes the internal floor plan, external walls, balconies, external circulation and articulation such as recesses and steps in plan and section.

Building separation

► Intent

The spacing between **buildings** influences the character of a location and the physical conditions of the built environment, as well as the **amenity** of individual residences by improving access to outlook, visual privacy, **daylight** and ventilation. As buildings get taller, it is important they have more separation to achieve these outcomes.

Generic building separation factors for all **development** covered under this policy are defined by the Primary Controls in Table 2.1.

Local governments may refine these parameters to suit local conditions via the **local planning framework**. Applicants must therefore address building separation provisions in applicable local planning instruments, where these differ to the default requirements of Table 2.7.

Related Elements

- 2.4 Side and rear setbacks
- 3.2 Orientation
- 3.5 Visual privacy
- 4.1 Solar and daylight access
- 4.2 Natural ventilation
- 4.6 Storage
- 4.7 Managing the impact of noise

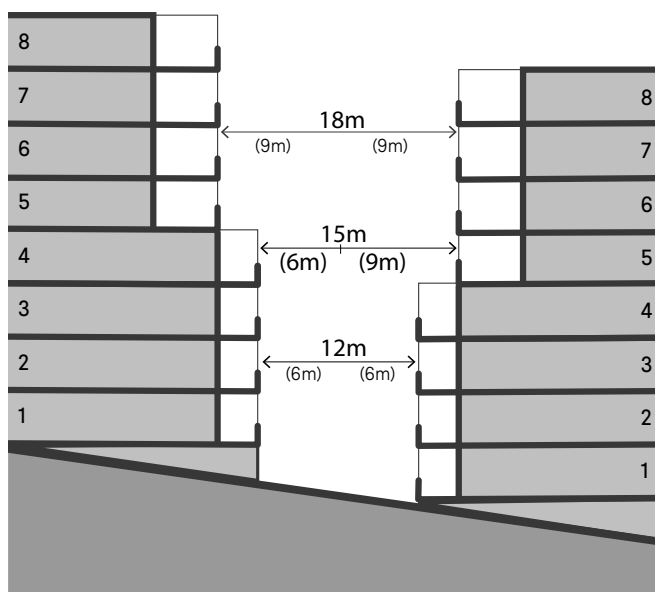

Figure 2.7a On sloping sites, appropriate building separation distances ensure visual privacy for apartments on different levels.

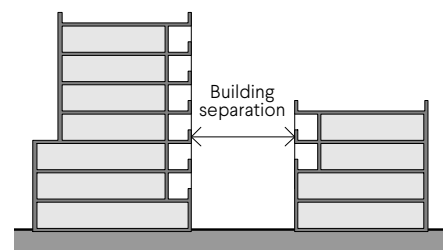

Figure 2.7b Building separation is measured from the outer face of building envelopes which includes balconies.

ELEMENT OBJECTIVES

Development is to achieve the following Element Objectives:

- O 2.7.1** New **development** supports the desired future **streetscape** character with spaces between **buildings**.
- O 2.7.2** **Building** separation is in proportion to building height.
- O 2.7.3** **Buildings** are separated sufficiently to provide for residential **amenity** including visual and **acoustic privacy**, **natural ventilation**, **sunlight** and **daylight** access and outlook.
- O 2.7.4** Suitable areas are provided for **communal** and **private open space**, **deep soil areas** and **landscaping** between **buildings**.

ACCEPTABLE OUTCOMES

In Part 2 only, Acceptable Outcomes are default provisions to assist in satisfying the objectives. In order to achieve the Element Objectives, proposals may require additional and/or alternative design solutions in response to the site conditions, streetscape and design approach where specified in the local planning framework (clause 1.2).

- A 2.7.1** **Development** complies with the separation requirements set out in Table 2.7.

Table 2.7 Building separation

	Separation between:	Building height		
		≤ 4 storeys (up to 15m)	5-8 storeys (up to 28m)	≥ 9 storeys (over 28m)
Within site boundary	Habitable rooms/balconies	12m	18m	24m
	Habitable and non-habitable rooms	7.5m	12m	18m
	Non-habitable rooms	4.5m	6m	9m
To adjoining property boundaries	Habitable rooms/balconies and boundary	Refer 2.4 Side and rear setbacks (Table 2.1) and 3.5 Visual privacy (Table 3.5)	9m	12m

Distances apply from major openings of rooms, or the inside of balustrading of balconies.
Average dimensions may be applied subject to major openings meeting other requirements for privacy, daylight and the like.

CONSIDERATIONS FOR LOCAL GOVERNMENTS

PLANNING GUIDANCE

- PG 2.7.1** Design and test **building** separation controls in plan and section.
- PG 2.7.2** Test **building** separation controls to ensure they promote **solar** and **daylight access** to buildings and provision of **open space**. For instance, building separation may need to be increased to achieve adequate **sunlight** access on **sites** with significant slopes.
- PG 2.7.3** Increase **building** separation proportionally to the building height to achieve **amenity** and privacy for building occupants.
- PG 2.7.4** When measuring **building** separation between commercial and residential uses, consider office windows and **balconies** as **habitable space** and service and plant areas as **non-habitable**.

Development incentives for community benefit

› **Intent**

This section provides guidance for local government on relevant considerations to establish **development** incentives that may be provided in exchange for community benefit in nominated areas. The application of development incentives should be led by the local government and are intrinsically linked to design excellence as established through design review. Accordingly this section does not provide grounds for development proponents to claim development incentives outside of designated provisions in local planning instruments.

Development incentives are a method through which additional development potential or flexibility (such as additional **plot ratio** and/or **building** height) is offered in exchange for tangible community benefit, such as public amenities, culture and recreation facilities or affordable and/or **accessible** housing. It is important that the cost and value of the community benefit can be objectively measured and assessed as the local government will need to determine whether the incentive is sufficient to attract investment in the desired community benefit, and also demonstrate that the value of the community benefit is broadly commensurate with the additional development entitlement.

Local governments will therefore need to give careful consideration to setting an appropriate range for this discretion and should seek feedback from the development and building industry to achieve a feasible trade-off between development bonuses and incentive provisions. Design Review Panel advice should also be sought to ensure that high quality design outcomes are achievable and are appropriate to the local context.

It is also important that development incentives be applied in a responsible and accountable manner to avoid the expectation that they become the 'default' development standard in a locality. Ideally development incentives would be confined to planned local areas included in **local planning schemes** and/or **precinct structure plans**, and/or limited to a focussed area or specific **site** that is identified for community infrastructure.

CONSIDERATIONS FOR LOCAL GOVERNMENTS

PLANNING OBJECTIVES

- **Development** incentives should be compatible with the objectives of this policy, the **local planning scheme**, applicable **precinct structure plans**, **local development plans** and **local planning policies**.
- Incentives should be chosen and weighted to reflect local priorities.
- Incentive-based provisions should provide clearly defined and measurable outcomes required to satisfy community benefit criteria.
- Incentives should be weighted so that the community outcomes are balanced with the benefit the developer achieves from the additional development allowed through varying the relevant **development** standard.
- Application of incentives should not result in adverse impacts on adjoining properties or the existing or desired **streetscape** character.

CONSIDERATIONS FOR LOCAL GOVERNMENTS

PLANNING GUIDANCE

PG 2.8.1 The following are examples of community benefit that may be considered in exchange for additional **development** potential or flexibility incorporated into a **local planning scheme**, **local development plan**, **precinct structure plan** or **local planning policy**.

- **Affordable housing:** development commits to deliver affordable **dwellings** in partnership with an approved housing provider or not-for-profit organisation recognised by the Housing Authority.
- **Dwelling diversity:** where providing a dwelling type identified as a priority by the local government, such as aged and dependent dwellings, **accessible dwellings**, one-bedroom **apartments**, key-worker dwellings or other innovative housing models to meet demand.
- **Heritage:** where a proposal delivers an exceptional outcome with regard to conserving and/or enhancing a place listed on the State Register of Heritage Places, a local planning scheme register or Local Government Heritage Inventory under the *Heritage of Western Australia Act 1990* (or the equivalent under the *Heritage Act 2018*) or a place that is located within a **heritage** area designated under the local planning scheme.
- **Retention of vegetation:** where significant mature or **native vegetation** is retained within a development **site** in excess of the Acceptable Outcomes at 3.3 *Tree canopy and deep soil areas*.
- **Public facilities:** development includes one or more of the following public facilities or amenities where identified as a priority by the local government:
 - **public open space**
 - public car parking
 - public pedestrian access ways and site linkages
 - provision of public facilities on private land, such as cultural facilities, public toilets, change rooms, end of trip facilities, meeting places, public pre-school or child care facilities and associated open space
 Consider whole of life costs including maintenance where public facilities are proposed.
- **Energy efficient design:** proposal demonstrates exceptional energy efficient design and a significant reduction in energy consumption.
- **Water conservation:** where the proposal demonstrates exceptional water management and conservation and a significant reduction in mains water use.

PG 2.8.2 When preparing planning provisions, local governments should give consideration to the weight that may be applied to individual elements and setting an 'upper cap' for allowable additional **development**. Weighting should be applied according to the local governments' desired outcomes and the amount of community benefit provided in exchange for the additional development potential or flexibility.

Siting the development

Siting the development provides guidance on the design and configuration of apartment development at a site scale.

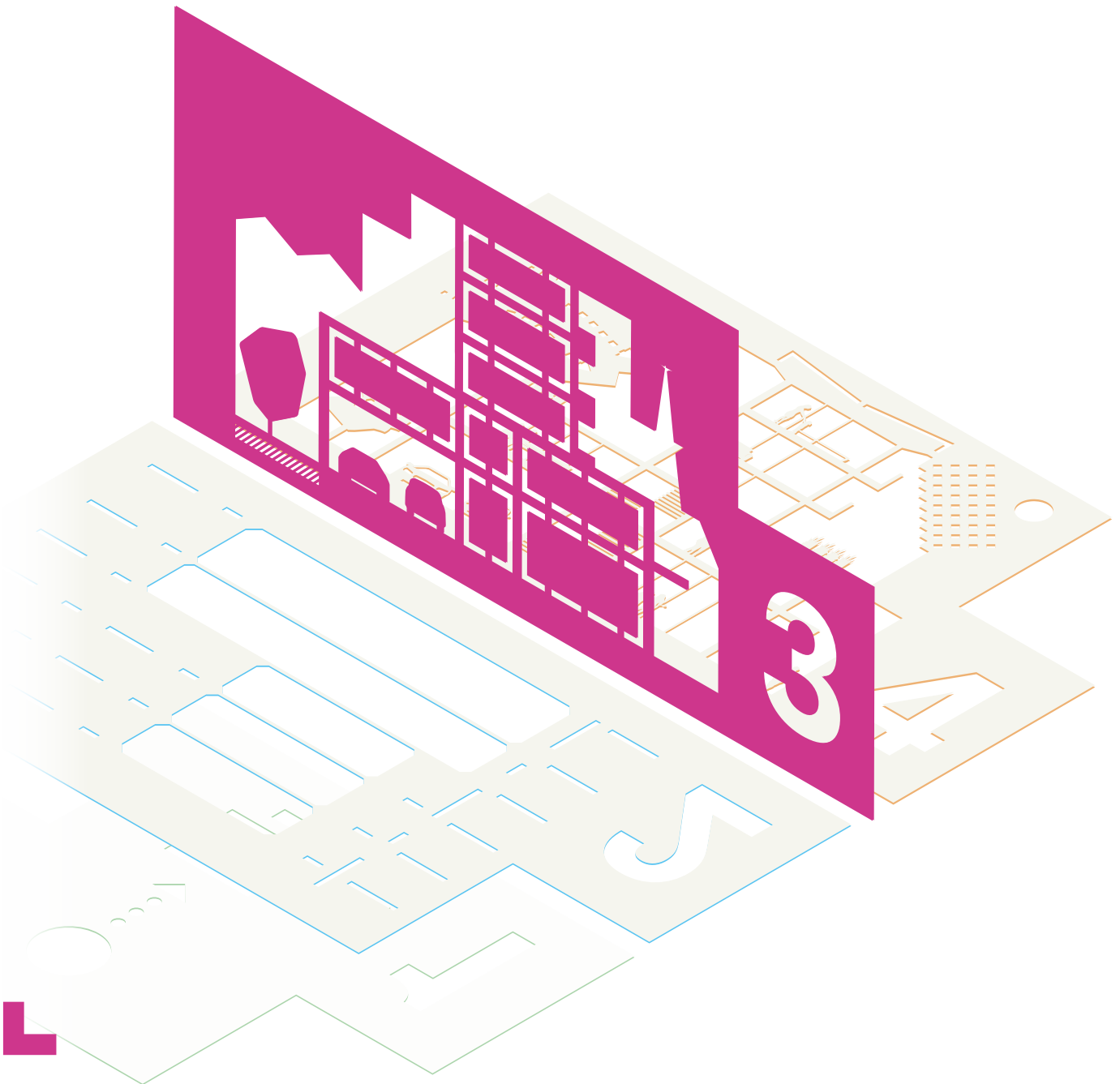

3

3.1	SITE ANALYSIS AND DESIGN RESPONSE	32
3.2	ORIENTATION	34
3.3	TREE CANOPY AND DEEP SOIL AREAS	36
3.4	COMMUNAL OPEN SPACE	40
3.5	VISUAL PRIVACY	44
3.6	PUBLIC DOMAIN INTERFACE	46
3.7	PEDESTRIAN ACCESS AND ENTRIES	50
3.8	VEHICLE ACCESS	52
3.9	CAR AND BICYCLE PARKING	54

Site analysis and design response

► Intent

The relationship of new **development** to the surrounding **streetscape**, natural environment and neighbourhood character is fundamental to good design. A thorough and systematic **site** analysis is a critical part of the design process, undertaken at the outset of a project to inform a positive design response to the opportunities and constraints of the site.

Many local planning instruments identify the existing or intended future character of an area and design should respond appropriately to the identified character and qualities. In areas undergoing change the design response must respond to the planned future character of the locality, while mitigating impacts on existing residents and development. Where **local character** is not defined, the site analysis process should inform a reasoned assessment of future character and the appropriate design response.

Site analysis should evaluate the physical and cultural elements of the locality, as well as the conditions affecting the site itself, so that opportunities and constraints for development can be addressed in the design response. The analysis must also reference any **local planning policies, precinct structure plans, local development plans** and other applicable local planning instruments, and demonstrate how the proposed development meets the requirements of these planning instruments.

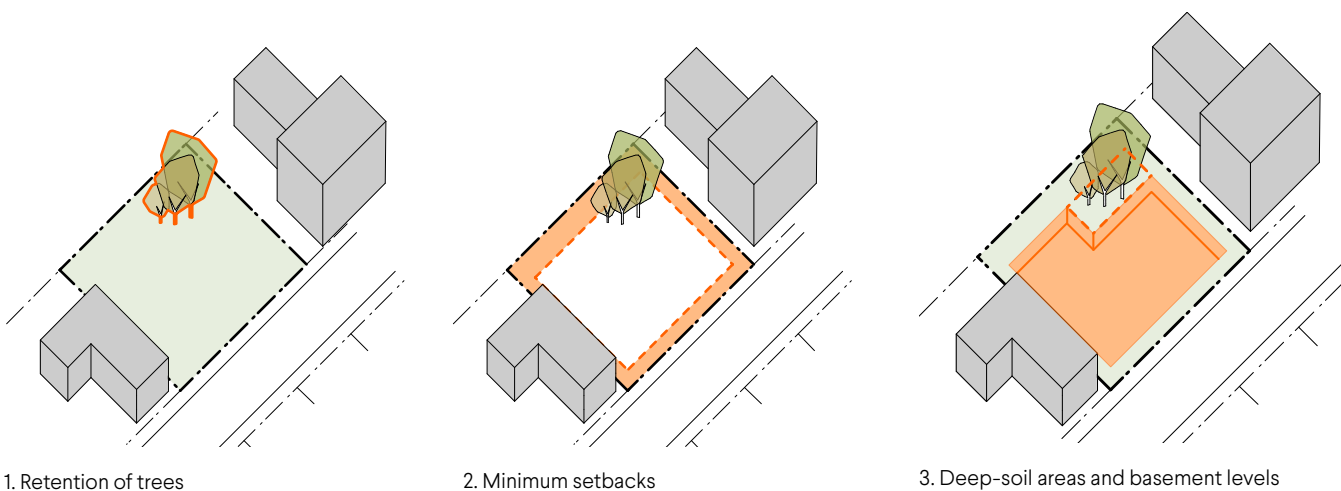

Figure 3.1a Site design response sequence.

DESIGN GUIDANCE

DG 3.1.1 A written and illustrated **site** analysis should be provided that demonstrates how the design response is informed by the site analysis and responds to surrounding context.

(Refer Appendix A3 *Site analysis and design response guidance*)

DG 3.1.2 The key elements of a **site** analysis include:

- Location plan – showing the broad community context including access to transport, employment, schools, shopping and services. This may include aerial photography
- Local context plan showing the features, attributes and character of the neighbourhood
- Site survey plan showing detailed site features including topography, vegetation, services and existing **development**
- **Streetscape** (photos and key features)
- For larger projects, simple three-dimensional modelling of the built form is encouraged
- Consideration of local planning instruments that relate to the site
- Incorporation of expert advice such as cultural, **heritage**, **landscape**, contamination, geotechnical and arboriculture
- Analysis and interpretation.

The level of detail should be appropriate for the complexity of the site and the scale and impact of the proposed development. Early discussions with the planning authority may assist in identifying relevant matters, specific requirements and acceptable responses.

DG 3.1.3 Local planning instruments applying to the **development site** should be considered and understood as part of the site analysis process.

DG 3.1.4 Depending on **site** factors, the **site design response** may require consultant advice for cultural, **heritage**, **landscape**, contamination, geotechnical and arboricultural matters. Early discussions with the planning authority may assist in identifying the relevant factors and specific requirements.

DG 3.1.5 Where design review and/or pre-lodgement enquiry processes are available, it is recommended that early presentations of **site** analysis and design responses are conducted to achieve timely and effective resolution of any major design issues that could influence the **development** approval.

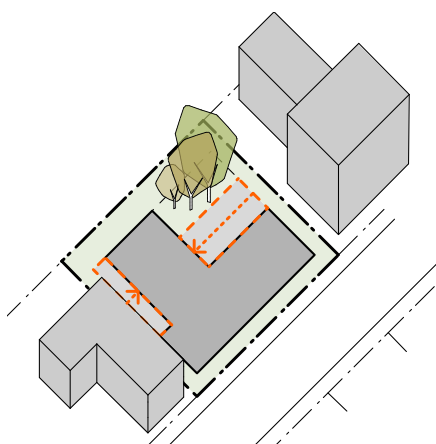

4. Building separation and depth

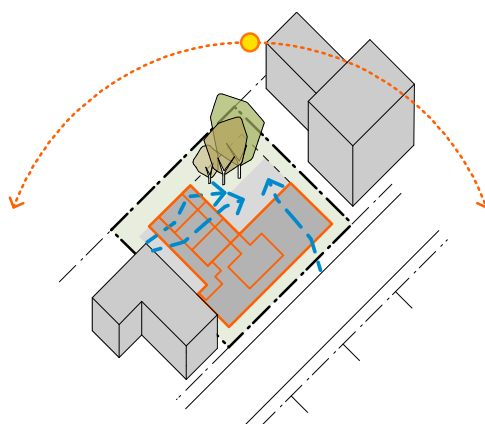

5. Building performance and orientation

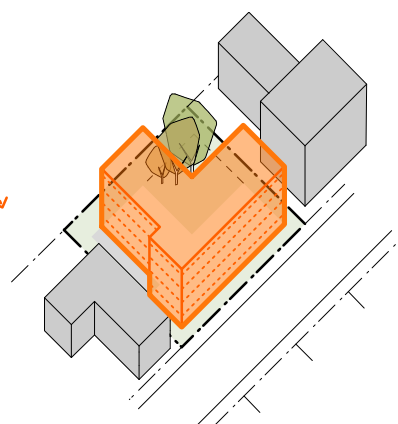

6. Three-dimensional built form

Orientation

↳ Intent

Orientation is the positioning of a **building**, and the activities and spaces within the building, in relation to the **site**, **street**, neighbouring buildings and climatic conditions. Building orientation influences the **streetscape** and directly affects residential **amenity** within the **development** and for neighbouring properties.

Early design analysis to optimise the orientation of buildings on a site makes it easier to achieve many of the objectives of this policy. Design response should demonstrate how building orientation seeks to balance and optimise the following considerations:

- Desired streetscape character and relationship to the public realm
- Climatic conditions such as **daylight** and **solar access** and prevailing winds
- Retention of existing trees and site features and/ or creation of new tree canopy and **open space**

- Attractive outlook from **habitable rooms** and **private open space**
- Avoiding overlooking, overshadowing and significant loss of amenity for neighbouring properties
- Passive management of noise sources and other environmental factors that may impact resident amenity.

Related Elements

- 2.3 Street setbacks
- 2.4 Side and rear setbacks
- 2.7 Building separation
- 3.4 Communal open space
- 4.1 Solar and daylight access



Figure 3.2a Proposed buildings are sited to clearly address the street while maximising solar access to apartments.

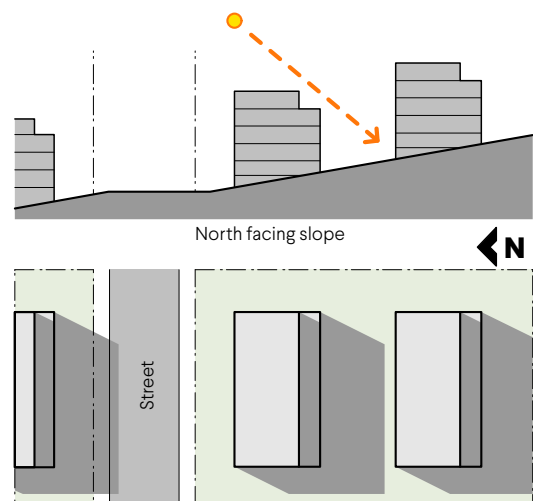

Figure 3.2b Building orientation and height influences solar access to apartments and common open spaces.

ELEMENT OBJECTIVES

Development is to achieve the following Element Objectives:

- O 3.2.1** Building layouts respond to the **streetscape**, topography and **site** attributes while optimising **solar** and **daylight access** within the **development**.
- O 3.2.2** Building form and orientation minimises overshadowing of the **habitable rooms**, **open space** and **solar collectors** of neighbouring properties during **mid-winter**.

ACCEPTABLE OUTCOMES

Acceptable Outcomes are likely to assist in satisfying the objectives but are not a comprehensive 'deemed-to-comply' list. In order to achieve the Element Objectives, proposals may require additional and/or alternative design solutions in response to the site conditions, streetscape and design approach.

- A 3.2.1** Buildings on **street** or public realm **frontages** are oriented to face the public realm and incorporate direct access from the street.
- A 3.2.2** Buildings that do not have **frontages** to **streets** or public realm are oriented to maximise northern **solar access** to living areas.
- A 3.2.3** Development in **climate zones** 4, 5 and 6 shall be designed such that the shadow cast at midday on 21st June onto any adjoining property does not exceed:
 - adjoining properties coded R25 and lower – 25% of the **site area**¹
 - adjoining properties coded R30 – R40 – 35% of the site area¹
 - adjoining properties coded R50 – R60 – 50% of the site area¹
 - adjoining properties coded R80 or higher – Nil requirements.
- A 3.2.4** Where adjoining **sites** are coded R40 or less, **buildings** are oriented to maintain 4 hours per day **solar access** on 21 June for existing **solar collectors** on neighbouring sites.

¹Where a development site shares its southern boundary with a lot, and that lot is bound to the north by other lot(s), the limit of shading at A 3.2.3 shall be reduced proportionally to the percentage of the affected properties northern boundary that abuts the development site. (Refer to Figure A7.2 in Appendix 7)

DESIGN GUIDANCE

Potential alternative solutions to satisfy the Element Objectives will be considered on a performance basis.

- DG 3.2.1** The **street frontage** of a **development** plays a role in defining the form and character of the street and should be sited and oriented accordingly. Development also contributes to the activation and surveillance of adjacent streets and should provide **passive surveillance** of the street and incorporate clear entries from the street to the extent possible.
- DG 3.2.2** Within the **site**, explore design solutions that configure the **building plan** to optimise **solar access** within the **development**, by maximising the number of **dwellings** and **open space** areas that have a northerly orientation. On sites that do not have good northern access, solar access to individual spaces may be improved through building articulation and use of **courtyards**.
- DG 3.2.3** The impact of **development** on **solar access** to properties located to the south must be considered. Measures such as increasing the **setback** of upper levels, breaking up **building mass** and orienting the development at right angles to the adjoining boundary may assist in improving solar access for neighbouring **sites**. In considering overshadowing of neighbouring properties priority should be given to achieving acceptable solar access to **habitable rooms**, outdoor living spaces and **solar collectors**.

Tree canopy and deep soil areas

► Intent

Trees and gardens make a significant contribution to the ecology, character and **amenity** of neighbourhoods. They provide habitat for fauna, shade, **stormwater** management and micro-climate benefits, as well as improve **apartment** outlook and privacy.

The removal of trees from private land is contributing to a significant loss of urban tree canopy, which can take decades to replace. The planning of a **development** should make all reasonable efforts to retain appropriate existing trees within the **site** and have no significant detrimental impact on trees on land adjoining the property.

The provision of **deep soil areas** to support and sustain the development of tree canopy can also make a major contribution to the retention of existing trees. A deep soil area is an area of soil that is free of built structure and has sufficient area and depth to support tree growth and infiltrate **rainwater**. Site planning should seek to co-locate deep soil areas with existing trees on and adjacent to the site, and in locations best suited to the development of a viable tree canopy and **landscaping**.

Achieving the requirement for deep soil areas may not be possible in some locations that have limited or no space for deep soil due to constraints such as the requirement for **basement** parking or in highly urbanised areas. These developments should locate landscaping on the structure wherever it provides the most benefit, such as on **podiums** or roof **terraces**, the greening of a lobby or softening car parking areas. Landscaping on structures should be of sufficient size and species selection to ensure that plants can thrive without causing damage to the **building**.

Related Elements

- 3.4 Communal open space
- 4.12 Landscape design
- 4.16 Water management and conservation



Photo 3.3a This large tree has been retained and the surrounding deep soil areas are being used for landscaping.

ELEMENT OBJECTIVES

Development is to achieve the following Element Objectives:

- O 3.3.1** Site planning maximises retention of existing healthy and appropriate trees and protects the viability of **adjoining trees**.
- O 3.3.2** Adequate measures are taken to improve tree canopy (long term) or to offset reduction of tree canopy from pre-**development** condition.
- O 3.3.3** **Development** includes **deep soil areas**, or other infrastructure to support planting on structures, with sufficient area and volume to sustain healthy plant and tree growth.

Table 3.3a Minimum deep soil area and tree provision requirements

Site Area	Minimum deep soil area	Minimum requirement for trees ¹
Less than 700m ²		1 medium tree and small trees to suit area
700 – 1,000m ²	10% OR	2 medium trees OR 1 large tree AND small trees to suit area
> 1,000m ²	7% if existing tree(s) retained on site (% site area)	1 large tree and 1 medium tree for each additional 400m ² in excess of 1000m ² OR 1 large tree for each additional 900m ² in excess of 1000m ² AND small trees to suit area

¹ Minimum requirement for trees includes retained or new trees
Refer Table 3.3b for tree sizes

Table 3.3b Tree sizes

Tree size	Indicative canopy diameter at maturity	Nominal height at maturity	Required DSA per tree	Recommended minimum DSA width	Minimum DSA width where additional rootable soil zone (RSZ) width provided ¹ (min 1m depth)	Indicative pot size at planting
Small	2-6m	3-8m	9m ²	2m	1m (DSA) + 1m (RSZ)	100L
Medium	6-9m	8-12m	36m ²	3m	2m (DSA) + 1m (RSZ)	200L
Large	>9m	>12m	64m ²	6m	4.5m (DSA) + 1.5m (RSZ)	500L

¹ Rootable areas are for the purposes of determining minimum width only and do not have the effect of reducing the required DSA.

ACCEPTABLE OUTCOMES

Acceptable Outcomes are likely to assist in satisfying the objectives but are not a comprehensive 'deemed-to-comply' list. In order to achieve the Element Objectives, proposals may require additional and/or alternative design solutions in response to the site conditions, streetscape and design approach.

- A 3.3.1** Retention of existing trees on the **site** that meet the following criteria:
 - healthy specimens with ongoing viability **AND**
 - species is not included on a State or local area weed register **AND**
 - height of at least 4m **AND/OR**
 - trunk diameter of at least 160mm, measured 1m from the ground **AND/OR**
 - average canopy diameter of at least 4m.
- A 3.3.2** The removal of existing trees that meet any of the criteria at A3.3.1 is supported by an arboriculture report.
- A 3.3.3** The **development** is sited and planned to have no detrimental impacts on, and to minimise canopy loss of **adjoining trees**.
- A 3.3.4** **Deep soil areas** are provided in accordance with Table 3.3a. Deep soil areas are to be co-located with existing trees for retention and/or **adjoining trees**, or alternatively provided in a location that is conducive to tree growth and suitable for **communal open space**.
- A 3.3.5** **Landscaping** includes existing and new trees with shade producing canopies in accordance with Tables 3.3a and 3.3b.
- A 3.3.6** The extent of **permeable paving** or decking within a **deep soil area** does not exceed 20 per cent of its area and does not inhibit the planting and growth of trees.
- A 3.3.7** Where the required **deep soil areas** cannot be provided due to **site** restrictions, planting on structure with an area equivalent to two times the shortfall in deep soil area provision is provided.

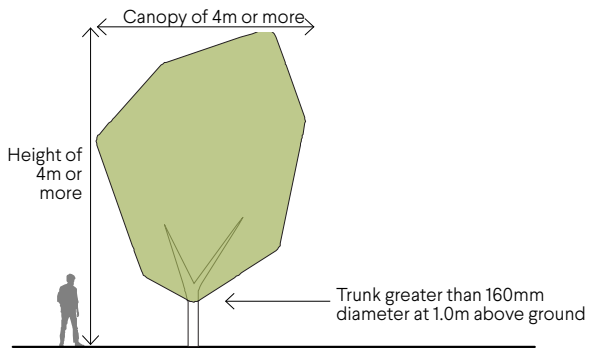

Figure 3.3a Size criteria used to identify existing trees for retention (refer A3.3.1 for full criteria).

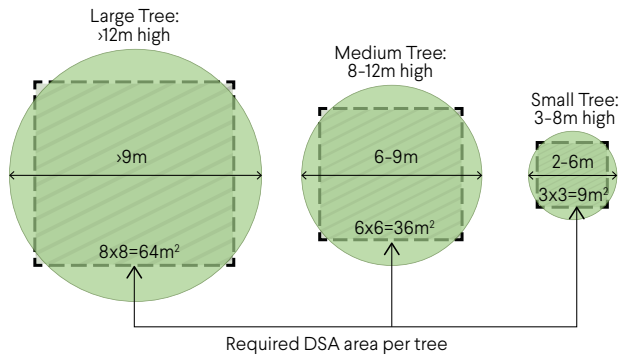

Figure 3.3b Tree size definitions when mature for deep soil areas.

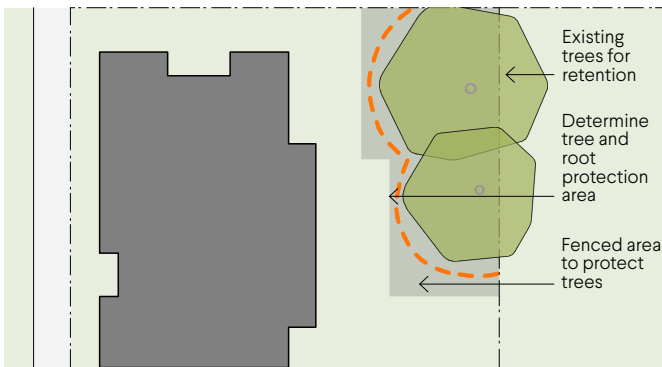

Figure 3.3c Tree and root protection areas should be identified and maintained throughout construction period.

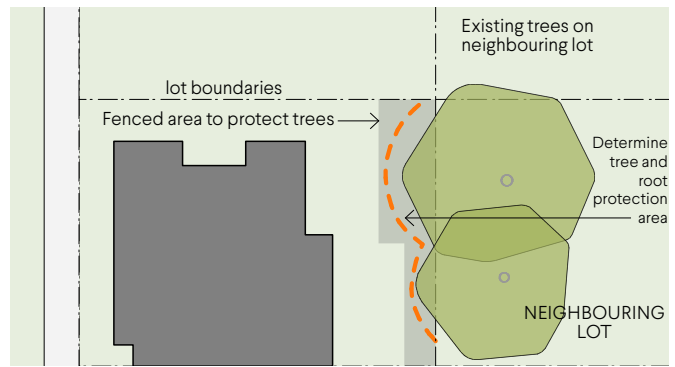

Figure 3.3d Trees on neighbouring lots and their root systems may also require protection during construction period.

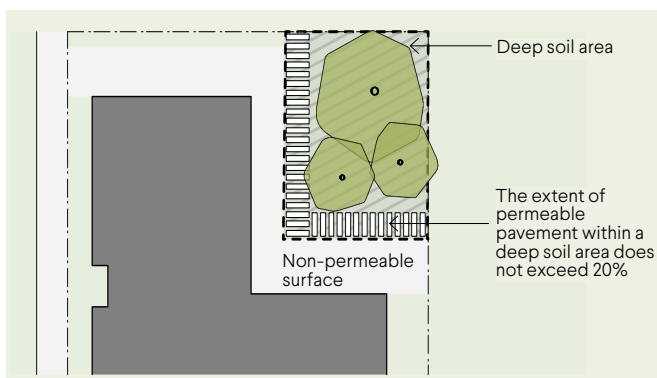

Figure 3.3e Deep soil area and permeable paving (refer A3.3.6).

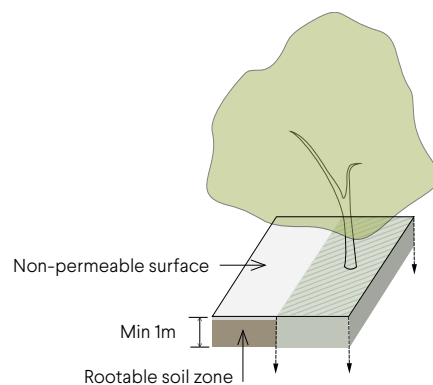

Figure 3.3f Rootable soil zone.

DESIGN GUIDANCE

Potential alternative solutions to satisfy the Element Objectives will be considered on a performance basis.

- DG 3.3.1** Existing and adjacent trees should be assessed during the **site** analysis phase for possible retention. Design testing should seek to retain trees and provide protection for adjacent trees. Where existing trees within the site or adjacent to the site boundary are identified for retention (or on site relocation), arboricultural advice should be obtained on the design of **deep soil areas** and management requirements to preserve the trees during and after construction.
- DG 3.3.2** The location of **deep soil areas** should be determined early in the design process and arboricultural advice obtained to ensure the deep soil areas can sustain trees. Where trees are being retained, the deep soil area should be co-located with the existing trees and be of sufficient dimensions to protect and sustain healthy root systems and provide stability for mature specimens. Where new trees are proposed, the deep soil area should be sited to maximise their contribution to local **amenity**, such as providing shade, contributing to the tree canopy, the quality of the **streetscape** and improving the outlook of residents.
- DG 3.3.3** Whole of **lot** design solutions to maximise tree canopy and the effectiveness of **deep soil areas** may include:
- **basement** and sub-basement car park design being consolidated beneath **building** footprints
 - use of increased front, side or rear **setbacks**
 - providing adequate clearance around trees to ensure long term health based on expert advice
 - the engineering of additional **rootable soil space** beneath proposed hardstand areas to increase the area available for root development and tree stability
 - co-location with other deep soil areas on neighbouring **sites** to create larger contiguous areas of deep soil (especially in rear setback areas)
 - selecting plant species that suit the available space and micro-climate of the deep soil area, including consideration that the size, shape and attributes of trees at maturity suit the location.
- DG 3.3.4** Where the required **deep soil areas** cannot be achieved, consider the following options for planting on structures:
- **green walls**, living walls and vertical gardens that enable **landscaping** of highly constrained spaces, supported by expert advice with respect to technical and maintenance considerations
 - wall design that incorporates planting including trellis structures
 - **green roofs**, particularly where roofs are visible from the **public domain** or other parts of the **development**
 - large scale planter boxes suited to small or medium trees.
- DG 3.3.5** Planting on structures will require expert technical advice for design and specification of the planting elements and systems. Planter requirements will need to be determined early in the design process to ensure they are of sufficient size to sustain plants and the **building** structure is reinforced to account for additional saturated soil weight.
- DG 3.3.6** Design should account for irrigation and for drainage pathways to reduce staining and ongoing maintenance of the planting infrastructure and the **building** fabric.
- DG 3.3.7** If extensive planting on structure is proposed, such as **green walls** or roofs, consider the use of an alternative water source, such as **rainwater** or recycled **greywater**.

Communal open space

► Intent

Well-designed **communal open space** provides residents with opportunities to recreate and socialise beyond their private living areas. Communal open space also creates **landscaping** opportunities between **buildings** that enhances resident **amenity** through the aesthetic and micro-climate benefits of landscaping and tree canopy. Communal open space that is located at **street** and public realm **frontages** may also increase interactions with the broader community.

The size, location and design of communal space will vary depending on the **site** context and the scale of **development**. Design solutions should provide quality spaces that benefit residents, visitors and, where appropriate, the public should have regard for how communal needs are currently met within the **walkable catchment** of the development and consider how the communal open space areas complement the public realm.

Developments that are located in high amenity areas, with a choice of recreation and social facilities for residents within a walkable catchment of 400m, may seek a reduction in the amount of communal open space, but are not exempt from providing at least one useable communal open space area (where this is required under this policy). Low-rise developments with large private **courtyards** to ground floor units may also seek a reduction in the amount of communal open space provided.

Related Elements

- 2.4 Side and rear setbacks
- 3.2 Orientation
- 3.3 Tree canopy and deep soil areas
- 4.4 Private open space and balconies
- 4.5 Circulation and common spaces
- 4.9 Universal design
- 4.11 Roof design
- 4.12 Landscape design

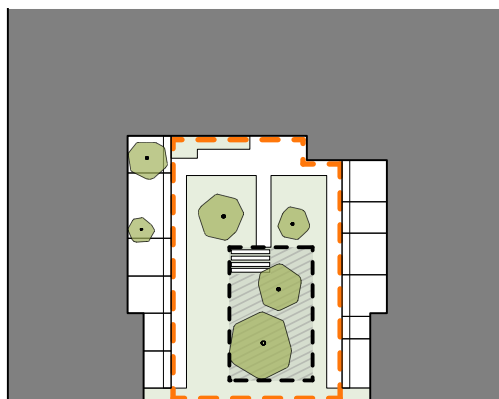

- Communal open space area
- Minimum deep soil area
- Permeable paving over deep soil area
- Communal garden
- Building

Figure 3.4a The principle usable part of communal open spaces should be consolidated.

ELEMENT OBJECTIVES

Development is to achieve the following Element Objectives:

- O 3.4.1** Provision of quality **communal open space** that enhances resident **amenity** and provides opportunities for **landscaping**, tree retention and **deep soil areas**.
- O 3.4.2** **Communal open space** is safe, **universally accessible** and provides a high level of **amenity** for residents.
- O 3.4.3** **Communal open space** is designed and oriented to minimise impacts on the **habitable rooms** and **private open space** within the **site** and of neighbouring properties.

ACCEPTABLE OUTCOMES

Acceptable Outcomes are likely to assist in satisfying the objectives but are not a comprehensive 'deemed-to-comply' list. In order to achieve the Element Objectives, proposals may require additional and/or alternative design solutions in response to the site conditions, streetscape and design approach.

- A 3.4.1** **Developments** include **communal open space** in accordance with Table 3.4.
- A 3.4.2** **Communal open space** located on the ground floor or on floors serviced by lifts must be **universally accessible** from the **primary street** entry of the **development**.
- A 3.4.3** There is 50 per cent direct **sunlight** to at least one **communal open space** area for a minimum of two hours between 9am and 3pm on 21 June.
- A 3.4.4** **Communal open space** is co-located with **deep soil areas** and/or planting on structure areas and/or co-indoor communal spaces.
- A 3.4.5** **Communal open space** is separated or screened from adverse **amenity** impacts such as bins, vents, condenser units, noise sources and vehicle circulation areas.
- A 3.4.6** **Communal open space** is well-lit, minimises places for concealment and is open to **passive surveillance** from adjoining **dwellings** and/or the public realm.
- A 3.4.7** **Communal open space** is designed and oriented to minimise the impacts of noise, odour, light-spill and overlooking on the **habitable rooms** and **private open spaces** within the **site** and of neighbouring properties.

Table 3.4 Provision of communal open space

Development size	Overall communal open space requirement	Minimum accessible / hard landscape area (included in overall area requirement)	Minimum open space dimension
Up to 10 dwellings	Informal seating associated with deep soil or other landscaped areas	NA	NA
More than 10 dwellings	Total: 6m ² per dwelling up to maximum 300m ²	At least 2m ² per dwelling up to 100m ²	4m

3 Siting the development

└ 3.4 Communal open space



Photo 3.4a Communal open space should be designed to be accessible, useable and attractive, allowing a range of activities for all residents.



Photo 3.4b An enclosed communal open space can be bright and airy when it is open to the sky. (PC)



Photo 3.4c This wide landscaped footpath doubles as communal open space, creating an environment conducive to incidental encounters between residents. The separation of buildings surrounding this space also allows for direct sunlight access.



Photo 3.4d This rooftop communal space provide a pool, BBQ, dining, as well as a shady, inviting environment for all users. (PC)



Photo 3.4e Communal open spaces are often located on the podium or rooftop and should offer gathering areas to provide opportunity for social interaction amongst residents. (PC)



Photo 3.4f This communal area has plenty of access to natural light, with private balconies overlooking and providing passive surveillance making it a safe, enjoyable environment.

DESIGN GUIDANCE

Potential alternative solutions to satisfy the Element Objectives will be considered on a performance basis.

DG 3.4.1 Communal open space may include outdoor and semi-**enclosed** and/or partially covered areas located at ground level or on upper level **podiums**, **terraces** or useable flat roofs. Communal open space should be sized and designed to be functional, **accessible** and attractive. On smaller **sites**, consider consolidating communal open space into a single easily identified and useable area. On larger sites, consider creating a series of communal open spaces that are well-integrated across the site and offer complementary uses.

DG 3.4.2 The siting of **communal open space** influences its **amenity** value. Consider climate and aspect including **solar access**, wind effects, noise and odours. Wherever possible co-locate communal open space with **deep soil areas**, planting on structure or other **landscaped** areas. Hard landscaping requirements may be included within deep soil areas if **permeable surfaces** are used up to the extent permissible in 3.3 *Tree canopy and deep soil areas*.

DG 3.4.3 Communal open space should be sited and designed to minimise the visual and aural impacts of services, such as ventilation duct outlets from **basement** car parks, air conditioning units, fire services, electrical substations and detention tanks.

DG 3.4.4 If indoor communal facilities are provided, explore opportunities to connect it with **communal open space** areas.

DG 3.4.5 Subject to the scale of **development**, the projected tenant demographic and available community infrastructure in the **walkable catchment**, **communal open space** may include:

- seating and play areas connected to high **amenity landscaping** and **deep soil areas**
- recreation facilities such as a pool, half-court basketball, tennis court or play equipment
- other facilities responding to particular community needs such as a dog exercise area or garden plots.

Where provided, give consideration to the potential impacts generated by these uses. For example, locate children's play areas or sports courts away from bedrooms to minimise noise impacts, and orient BBQs to reduce the impact of odour and smoke. External lighting should cast light downward and reduce upward light spillage where possible, to reduce the impact on **dwellings** and wildlife.

DG 3.4.6 The maintenance of **communal open space** is typically a shared expense for owners. Communal open space should therefore be designed to be robust and easily maintained.

DG 3.4.7 Where **communal open space** includes space that is accessible to the general public it should:

- include an effective wayfinding system
- be well connected with public **streets** or **public open space** along at least one edge, or via a pedestrian path with clear **sightlines**
- be designed for public safety.

Visual privacy

► Intent

The design of **apartments** must carefully balance the need for outlook and **daylight** access with the need for privacy. A room with generous glazing for views and daylight, if poorly oriented, might feel too exposed and overlooked by neighbours or passers-by. Conversely, spaces that are well-screened for privacy may create a dark, constrained internal environment.

Resolving visual privacy issues involves consideration of the views to and from an apartment, between apartments within a **development**, between a development and neighbouring properties, and the potential for overlooking of communal or private outdoor spaces. Addressing these issues through the effective separation and orientation of **buildings** and the considered placement and orientation of rooms and windows reduces the need for excessive **screening**. The separation and orientation of buildings may also benefit neighbourhood character through the retention of view corridors, **open space** and **landscaping**, as well as reducing the perceived bulk and scale of development.

Table 3.5 details standards that generally avoid undesirable conditions. Alternative design solutions may be justified through building siting and articulation. It is also noted that lower levels of visual privacy may be acceptable in denser urban contexts than in low-rise residential areas and this may be a consideration in determining an appropriate design response.

Related Elements

- 2.3 *Street setbacks*
- 2.4 *Side and rear setbacks*
- 2.7 *Building separation*

ELEMENT OBJECTIVES

Development is to achieve the following Element Objectives:

- O 3.5.1** The orientation and design of **buildings**, windows and **balconies** minimises direct overlooking of **habitable rooms** and private outdoor living areas within the **site** and of neighbouring properties, while maintaining **daylight** and **solar access**, ventilation and the external outlook of habitable rooms.

ACCEPTABLE OUTCOMES

Acceptable Outcomes are likely to assist in satisfying the objectives but are not a comprehensive 'deemed-to-comply' list. In order to achieve the Element Objectives, proposals may require additional and/or alternative design solutions in response to the site conditions, streetscape and design approach.

- A 3.5.1** Visual privacy **setbacks** to side and rear boundaries are provided in accordance with Table 3.5.
- A 3.5.2** **Balconies** are unscreened for at least 25 per cent of their perimeter (including edges abutting a **building**).
- A 3.5.3** Living rooms have an external outlook from at least one major opening that is not obscured by a screen.
- A 3.5.4** Windows and **balconies** are sited, oriented, offset or articulated to restrict direct overlooking, without excessive reliance on high sill levels or permanent **screening** of windows and balconies.

Table 3.5 Required privacy setback to adjoining sites

Cone of vision from unscreened (refer Figure series A7.3):	First 4 storeys		5th storey and above
	Adjoining sites coded R50 or lower	Adjoining sites coded higher than R50	
Major opening to bedroom, study and open access walkways	4.5m	3m	Refer Table 2.7
Major openings to habitable rooms other than bedrooms and studies	6m	4.5m	
Unenclosed private outdoor spaces	7.5m	6m	

DESIGN GUIDANCE

Potential alternative solutions to satisfy the Element Objectives will be considered on a performance basis.

- DG 3.5.1** For people to feel comfortable living in higher-density environments, the siting of **buildings** and the design of **apartments** should carefully balance the need for outlook with the need for privacy.
- DG 3.5.2** Document the location of existing windows and **balconies** in adjoining **buildings** during the **site** analysis phase and endeavour to offset new **habitable room** windows and balconies from existing ones.
- DG 3.5.3** Retaining an open aspect from **balconies** and principal windows in interior rooms is critical for resident **amenity**. Screens, enclosures, **highlight windows**, or **landscape** elements should not be used to justify a reduction in the visual privacy **setbacks** for the primary outlook from interior spaces. While balconies can increase internal privacy they may also restrict **daylight** access.
- DG 3.5.4** Bedrooms, living spaces and other **habitable rooms** should be separated from gallery **walkway** access and other open circulation space by the **apartment's service areas** or **lightwells**.
- DG 3.5.5** **Communal open space**, common areas and access paths should be separated from **private open space** and **apartment** windows, particularly to **habitable rooms**. Design solutions may include:
- increased **setbacks**
 - solid or partially-solid balustrades to **balconies** at lower levels
 - use of fencing and/or trees and vegetation to separate spaces
 - **screening** devices
 - changes of level
 - **bay windows** or pop out windows to direct outlook away from other **dwellings**
 - planter boxes incorporated into walls and balustrades
 - pergolas or shading devices to limit overlooking of lower dwellings or private open space
 - portions of fixed louvres or screen panels to windows and balconies.

Public domain interface

► Intent

New **development** can have a significant impact on public areas and **streetscapes**. The interface between **buildings** and the **public domain** is particularly important for ensuring a successful transition that contributes to the quality and character of the **street**. The design of attractive and pedestrian-friendly **frontages** requires well-considered arrangements of planting, fencing, **screening** and **site** entries that balance an open street frontage at pedestrian scale, with the security and privacy of residents.

Streetscape appeal and activity is improved by ground floor uses that complement the intended streetscape, particularly street facing activities that enable casual surveillance and greater interaction between the street and the building.

Related Elements

- 2.3 Street setbacks
- 2.4 Side and rear setbacks
- 3.7 Pedestrian access and entries
- 3.8 Vehicle access
- 3.9 Car and bicycle parking
- 4.9 Universal design
- 4.14 Mixed use
- 4.17 Waste management
- 4.18 Utilities



Photo 3.6a The upper level balconies of this development overlook public open space providing the residents with an attractive outlook while providing passive surveillance of the public domain.



Photo 3.6b The landscaping of this development enhances the amenity of the adjoining public domain while providing visual privacy for residents.



Photo 3.6c The landscaping in front of these buildings contribute to a positive streetscape character, with building frontages and entries onto the street. The multiple entrances also help to activate the street edge, while providing passive surveillance over the public street.

ELEMENT OBJECTIVES

Development is to achieve the following Element Objectives:

O 3.6.1 The transition between the private and **public domain** enhances the privacy and safety of residents.

O 3.6.2 Street facing **development** and **landscape** design retains and enhances the **amenity** and safety of the adjoining **public domain**, including the provision of shade.

ACCEPTABLE OUTCOMES

Acceptable Outcomes are likely to assist in satisfying the objectives but are not a comprehensive 'deemed-to-comply' list. In order to achieve the Element Objectives, proposals may require additional and/or alternative design solutions in response to the site conditions, streetscape and design approach.

A 3.6.1 The majority of ground floor **dwelling**s fronting onto a **street** or **public open space** have direct access by way of a private **terrace, balcony** or **courtyard**.

A 3.6.2 Car-parking is not located within the **primary street setback**; and where car parking is located at ground level behind the street setback it is designed to integrate with **landscaping** and the **building façade** (where part of the building).

A 3.6.3 Upper level **balconies** and/or windows overlook the **street** and **public domain** areas.

A 3.6.4 Balustrading includes a mix of visually opaque and **visually permeable** materials to provide residents with privacy while maintaining casual surveillance of adjoining **public domain** areas.

A 3.6.5 Changes in level between private **terraces, front gardens** and the ground floor level of the **building** and the **street** level average less than 1m and do not exceed 1.2m.

A 3.6.6 Front fencing includes **visually permeable** materials above 1.2m and the average height of solid walls or fences to the **street** does not exceed 1.2m.

A 3.6.7 Fencing, **landscaping** and other elements on the **frontage** are designed to eliminate opportunities for concealment.

A 3.6.8 Bins are not located within the **primary street setback** or in locations visible from the primary street.

A 3.6.9 Services and **utilities** that are located in the **primary street setback** are integrated into the design of the **development** and do not detract from the **amenity** and visual appearance of the **street frontage**.¹

¹ Firefighting and access to services such as power and water meters require careful consideration in the design of the front façade. Consult early with relevant authorities to resolve functional requirements in an integrated design solution.

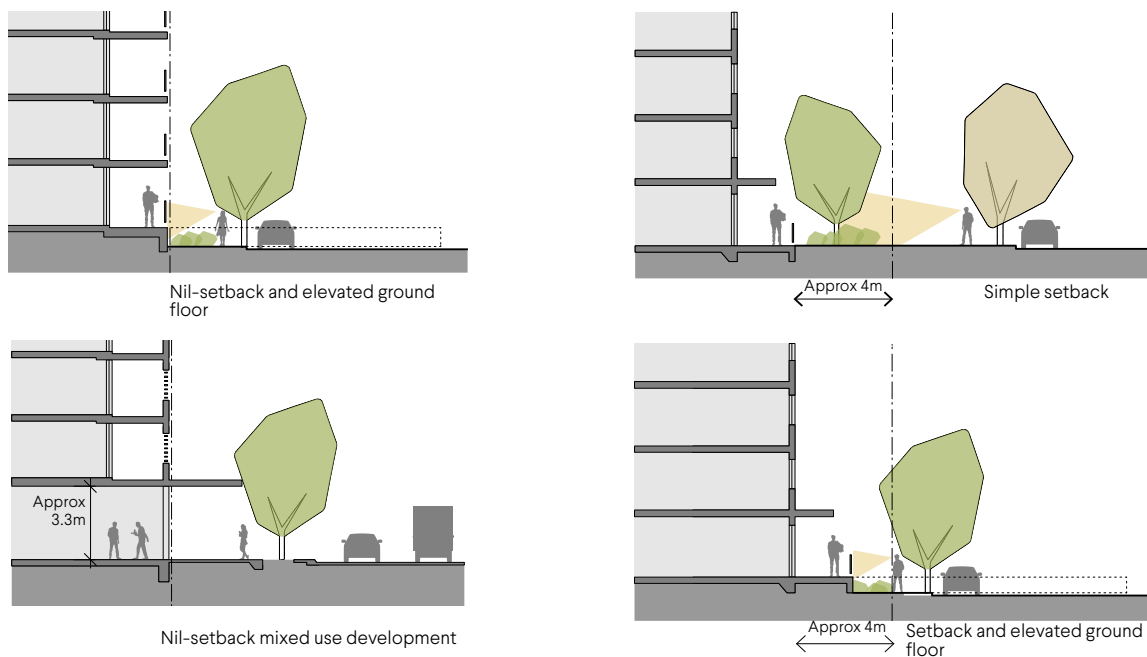

Figure 3.6a Diagrams illustrating various public domain interface scenarios.

3 Siting the development

└ 3.6 Public domain interface



Photo 3.6d Amenity of the public domain is retained and enhanced. The balconies and windows overlooking the street provide passive surveillance.



Photo 3.6e The raised planter and landscaping enhance the privacy of these ground floor apartments, improve the public domain interface and at the same time contribute to the greening of the streetscape.



Photo 3.6f A level change between private terraces, front gardens and dwelling entries and the street provide surveillance and improve visual privacy for ground level dwellings.



Photo 3.6g An eye level/street view of the same development in Photo 3.6h below, showing how the building interacts with the street defining the streetscape for the area. (PC)



Photo 3.6h Some good public interface elements are demonstrated here: the three street entry points are clearly legible, one of them has universal access; change in level between footpath and front courtyards for privacy allowing for largely permeable fencing; upper level balconies and windows overlook the street and public domain areas ensure public surveillance; mix of textures and materials provide pedestrian interest; mail boxes and bike racks are well integrated along front fences; landscaping provision is generous and enhances the layout design. (PC)

DESIGN GUIDANCE

Potential alternative solutions to satisfy the Element Objectives will be considered on a performance basis.

- DG 3.6.1** Key components to consider when designing the interface with the **public domain** include entries, private **terraces** or **balconies**, fences and walls, changes in level, services locations and planting. These elements need to balance the requirement for **passive surveillance** with visual privacy. The design of these elements can influence the real or perceived safety and security of residents, promote opportunities for social interaction and enhance the **street** appeal of the **development**.
- DG 3.6.2** To improve **passive surveillance**, promote **street setbacks** which enable a person on a **balcony** or at a window to easily see the street. For **apartments** at ground floor close to the street, raising the floor height by 0.5m to 1m can be an effective way to maintain an appropriate balance between passive surveillance and privacy for residents.
- DG 3.6.3** Ground floor uses should complement the intended **streetscape**, balancing retail, commercial and residential elements, and avoiding excessive vehicle and service elements or blank walls. The visual prominence of underground car park vents should be minimised and located at a low level where possible.
- DG 3.6.4** Direct **street** entry to **terraces**, **balconies** and **courtyard apartments** is desirable where it can be achieved. **Building** entries should be readily identifiable and designed for **universal access**. Where there are multiple buildings and/or entries utilise architectural detailing, materials, colours and **landscape** treatments to differentiate the entries and improve **legibility** for residents and visitors.
- DG 3.6.5** Services such as fire **utilities**, rubbish collection areas and mailboxes should be easy to locate without being visually prominent through careful integration into the overall design of the **development**. Mail boxes should be located in lobbies perpendicular to the **street** alignment or integrated into front fences where individual street entries are provided.
- DG 3.6.6** Consider opportunities to promote casual interaction between residents and the **public domain**. Design solutions may include seating at **building** entries, near letter boxes and in private **courtyards** adjacent to **streets**.
- DG 3.6.7** Blank walls facing the **street frontage** should be avoided wherever possible. Blank walls can be broken up with entries, open screens, fencing, **landscaping** and other elements that provide greater visual interest when viewed from the street.
- DG 3.6.8** Where the recommended parameters for level change, fence height, permeability and activation cannot be achieved, consider planting, additional **setbacks** and materiality to minimise impacts to the **streetscape**.
- DG 3.6.9** Where **development** adjoins public parks, **open space** or bushland, the design positively addresses this interface. Potential design solutions include:
- direct **street** access, pedestrian paths and clearly defined **building** entries
 - paths, low fences and planting that clearly delineate between **communal** and **private open space** and the adjoining **public open space**
 - minimising the use of blank walls, solid fences and ground level parking.
- DG 3.6.10** On-site tree planting within the **public domain** interface should be responsive to street tree planting. For example, on **streets** with minimal verge width or tree canopy, consider how the **development** can positively contribute to tree canopy and shade provision of the public domain.

Pedestrian access and entries

► Intent

The experience of residents and visitors walking into an **apartment building** should be comfortable, safe and easy to navigate.

Building entries and accessways provide the key connection between the public and private realm and their design should reflect this important role. They should be easy to find, while being well integrated into the overall design of the **development** and the **streetscape**. Access to individual apartments from the **street** or through **open space** and circulation areas should be intuitive, even for a first time visitor.

Related Elements

- 3.6 Public domain interface
- 3.8 Vehicle access
- 4.5 Circulation and common spaces
- 4.9 Universal design
- 4.18 Utilities



Photo 3.7a An entrance portico offers shelter, security and a recognisable point of address.



Photo 3.7b Successful building entries delineate public and private spaces, are clearly identifiable and help to animate the street. (PC)



Photo 3.7c Signage should respond to the context and desired streetscape character. Here the building address signage has been integrated as a feature of the façade design. (PC)

ELEMENT OBJECTIVES

Development is to achieve the following Element Objectives:

- O 3.7.1** Entries and pathways are **universally accessible**, easy to identify and safe for residents and visitors.
- O 3.7.2** Entries to the **development** connect to and address the **public domain** with an attractive **street** presence.

ACCEPTABLE OUTCOMES

Acceptable Outcomes are likely to assist in satisfying the objectives but are not a comprehensive 'deemed-to-comply' list. In order to achieve the Element Objectives, proposals may require additional and/or alternative design solutions in response to the site conditions, streetscape and design approach.

- A 3.7.1** Pedestrian entries are connected via a legible, well-defined, **continuous path of travel** to **building** access areas such as lift lobbies, stairs, accessways and individual **dwelling** entries.
- A 3.7.2** Pedestrian entries are protected from the weather.
- A 3.7.3** Pedestrian entries are well-lit for safety and **amenity**, visible from the **public domain** without opportunity for concealment, and designed to enable casual surveillance of the entry from within the **site**.
- A 3.7.4** Where pedestrian access is via a shared zone with vehicles, the pedestrian path is clearly delineated and/or measures are incorporated to prioritise the pedestrian and constrain vehicle speed.
- A 3.7.5** Services and **utilities** that are located at the pedestrian entry are integrated into the design and do not detract from the **amenity** of the entry.
- A 3.7.6** Bins are not located at the primary pedestrian entry.

DESIGN GUIDANCE

Potential alternative solutions to satisfy the Element Objectives will be considered on a performance basis.

- DG 3.7.1** Primary entries to the **site** and **building(s)** should be clearly identifiable from the **street**.
- For taller **developments**, a clearly defined and visible lobby or waiting area should be provided to lifts and stairs
 - On sites with a narrow street **frontage**, consider a **primary street** address with clear **sightlines** and pathways to secondary building entries
 - Where there are multiple entries, consider design treatments that provide a clear visual hierarchy to distinguish and identify communal entries from private entries, residential entries from non-residential activities and pedestrian entries from vehicle
 - Design solutions might include awnings, architectural detailing, materials, colour and **landscape** treatments.
- DG 3.7.2** The design of entries should incorporate **CPTED** principles. Direct, clearly visible and well lit access is required from the **street** entry to common circulation areas. Consider lighting and design elements that ensure entries are legible and safe to access at night.
- DG 3.7.3** Entries shall be designed in accordance with **universal design** principles. The design of ground floors and car parks should minimise level changes along pathways and at entries. It is often preferable for the entrance to be at **street** level and the level transitions to occur within the **building**. Where required, integrate ramps and steps into the overall building and **landscape** design.
- DG 3.7.4** Pedestrian and vehicle paths should be separated wherever possible, with pedestrians given priority over vehicles. Where pedestrian entry is via a shared vehicle space, consider using measures such as a pedestrian gate, differentiated surface, lighting and/or signage to provide a distinct pedestrian entry.
- DG 3.7.5** Where security gates are used, consider providing a set-back from the footpath to allow space for a pedestrian to stand while opening the gate without blocking the footpath.
- DG 3.7.6** For large **developments** 'wayfinding' signage and maps are recommended to assist visitors and residents, with intercom controls to manage visitor access to private areas.
- DG 3.7.7** **Service areas** located at the **building** entry areas (such as fire **utilities** and mailboxes) should be easy to locate, functional and carefully integrated into the overall design of the **development**. Consider access and locations for the delivery of large parcels and shopping.
- DG 3.7.8** On large **sites** consider opportunities to provide pedestrian links through the site to provide connections to **open space**, main **streets**, centres and public transport, and to increase site activation. Pedestrian links should be direct, with clear **sightlines** and **passive surveillance** from **dwellings** within the **development**, while maintaining appropriate privacy for residents. Consider integrating passive spaces, such as seating, to facilitate casual interaction.

Vehicle Access

► Intent

Vehicle access points are essential connections between the **street** and parking or delivery areas within the **development**. Well-designed access and circulation areas improve safety and functionality for users, whereas poorly considered vehicle access may compromise the safety of pedestrians, residents and traffic, as well as having a detrimental effect on the appearance and **amenity** of the **streetscape**. Design needs to balance the need for safe and efficient vehicle access and egress with the needs of pedestrians, other road users and impacts on the public realm.

Related Elements

- 2.3 Street setbacks
- 3.6 Public domain interface
- 3.7 Pedestrian access and entries
- 3.9 Car and bicycle parking
- 4.17 Waste management

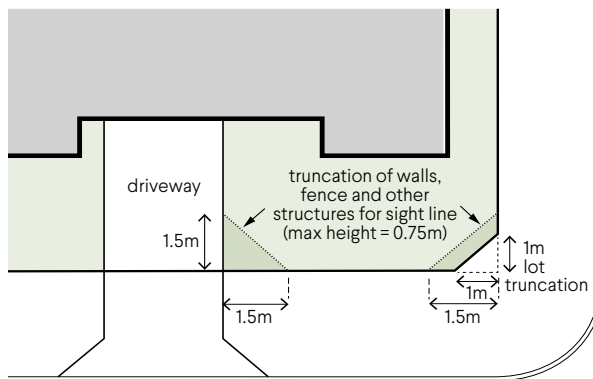

Figure 3.8a Truncation at street corner to provide sightlines (refer A3.8.7).



Photo 3.8a This clear vehicular access has a low impact on the streetscape and integrated well into the façade design of the building.

ELEMENT OBJECTIVES

Development is to achieve the following Element Objectives:

- O 3.8.1** Vehicle access points are designed and located to provide safe access and egress for vehicles and to avoid conflict with pedestrians, cyclists and other vehicles.
- O 3.8.2** Vehicle access points are designed and located to reduce visual impact on the **streetscape**.

ACCEPTABLE OUTCOMES

Acceptable Outcomes are likely to assist in satisfying the objectives but are not a comprehensive 'deemed-to-comply' list. In order to achieve the Element Objectives, proposals may require additional and/or alternative design solutions in response to the site conditions, streetscape and design approach.

- A 3.8.1** Vehicle access is limited to one opening per 20m **street frontage** that is visible from the street.
- A 3.8.2** Vehicle entries are identifiable from the **street**, while being integrated with the overall **façade** design and/or located behind the primary **building line**.
- A 3.8.3** Vehicle entries have adequate separation from **street** intersections.
- A 3.8.4** Vehicle circulation areas avoid headlights shining into **habitable rooms** within the **development** and adjoining properties.
- A 3.8.5** **Driveway** width is kept to a functional minimum, relative to the traffic volumes and entry/egress requirements.
- A 3.8.6** **Driveways** designed for two way access to allow for vehicles to enter the **street** in forward gear where:
 - the driveway serves more than 10 **dwellings**
 - the distance from an on-**site** car parking to the street is 15m or more **OR**
 - the public street to which it connects is designated as a primary distributor, district distributor or integrated arterial road.
- A 3.8.7** Walls, fences and other structures truncated or reduced to no higher than 0.75m within 1.5m of where walls, fences, other structures adjoin vehicle access points where a **driveway** meets a public **street** and where two streets intersect (refer Figure 3.8a).

DESIGN GUIDANCE

Potential alternative solutions to satisfy the Element Objectives will be considered on a performance basis.

- DG 3.8.1** Good design can reduce the visual impact of vehicle access at the **street frontage**. Consider:
 - providing access from a **secondary street** where possible
 - keeping the width to a minimum and avoiding vehicle standing areas within the street **setback**
 - in built passing points but not the full **driveway** length
 - positioning ramps, gates and roller doors behind the main **building** frontage
 - selecting materials and colours that identify the access point while integrating with the built form and **streetscape**
 - minimising voids in the building façade through the use of doors or gates at entries or returning the **façade** detailing along exposed sides/interior of driveways
 - concealing building services, pipes and ducts within visible parking areas.
- DG 3.8.2** Locate and design vehicle access to minimise impacts on pedestrians, in particular ensuring that vehicles exiting the **site** have adequate visibility of oncoming pedestrians, cyclists and vehicles.
- DG 3.8.3** Visitor bays are readily accessed from the primary vehicle entry. Where located inside security gates, provide intercom controls to facilitate visitor access.
- 3.8.4** Consider design solutions to reduce the impact of vehicle entries and circulation areas within the **site** accommodating appropriate **sightlines** and safety considerations, such as:
 - using changes in materials, colour, levels or **landscaping** to delineate pedestrian and vehicle circulation areas and define pedestrian paths in shared areas
 - locating vehicle entries to minimise ramp lengths and excavation
 - where required, incorporating aesthetically pleasing traffic calming devices that are integrated into the design such as changes in paving material or textures
 - reducing parts of the **driveway** to single lane (3m width) to allow for the incorporation of **deep soil areas**
 - minimising the visual impact of unavoidable long driveways through changing alignments and screen planting.
- DG 3.8.5** Minimise the need for large vehicles to enter and manoeuvre within the **site**. Where it is required, ensure a well-planned path of travel with sufficient clearance distances and site lines. This requires consideration of **building** servicing requirements, including waste collection, during the preliminary design.

Car and bicycle parking

► Intent

Car parking within **apartment buildings** can have a significant impact on **site** planning, **landscape** and building design. It requires careful consideration in the design phase to ensure that car parking provided does not detract from the overall design intent or the intended character of the **streetscape**.

Car parking can account for significant land-take at the expense of landscaping and **open space**. Car parking areas can also have negative environmental impacts such as heat gain from solar absorption, glare and **stormwater** contamination. Reducing on-site parking requirements can mitigate these impacts and may also encourage greater use of alternative transport modes to the private vehicle. On the other hand residents expect adequate, safe and **accessible** car parking and the local community should not be adversely impacted by on-**street** parking associated with **development**.

The design process must balance these requirements to provide sufficient parking that is well integrated into the overall design of the development and does not detract from the streetscape.

Related Elements

- 2.3 Street setbacks
- 3.6 Public domain interface
- 3.8 Vehicle access

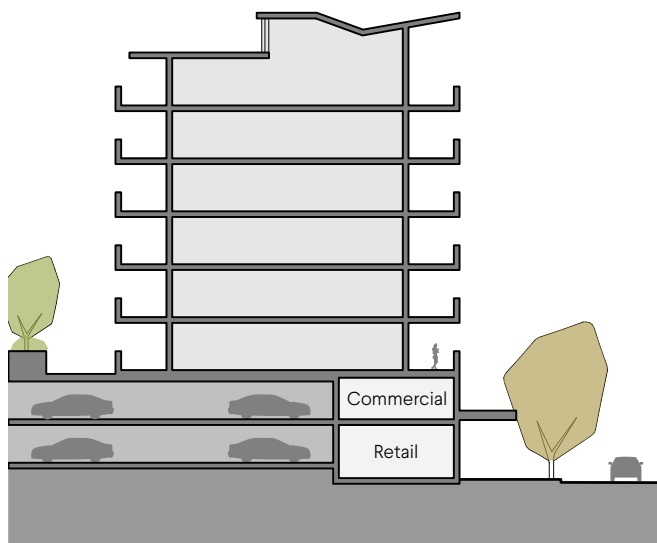

Figure 3.9a Above-ground parking should be concealed behind the building façade and wrapped with other uses along the primary street frontage.

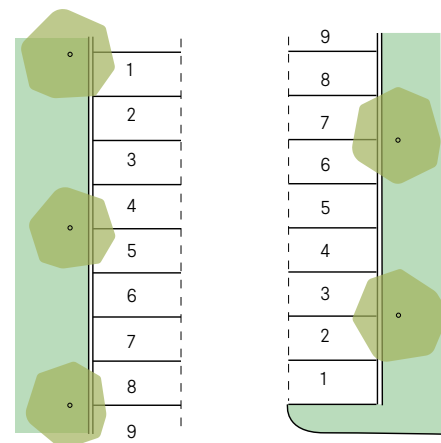

Figure 3.9b Every four at-grade parking bays should be planted with trees (refer A3.9.9).

ELEMENT OBJECTIVES

Development is to achieve the following Element Objectives:

- O 3.9.1** Parking and facilities are provided for cyclists and other modes of transport.
- O 3.9.2** Car parking provision is appropriate to the location, with reduced provision possible in areas that are highly walkable and/or have good public transport or cycle networks and/or are close to employment centres.
- O 3.9.3** Car parking is designed to be safe and **accessible**.
- O 3.9.4** The design and location of car parking minimises negative visual and environmental impacts on **amenity** and the **streetscape**.

ACCEPTABLE OUTCOMES

Acceptable Outcomes are likely to assist in satisfying the objectives but are not a comprehensive 'deemed-to-comply' list. In order to achieve the Element Objectives, proposals may require additional and/or alternative design solutions in response to the site conditions, streetscape and design approach.

- A 3.9.1** Secure, undercover bicycle parking is provided in accordance with Table 3.9 and accessed via a **continuous path of travel** from the vehicle or cycle entry point.
- A 3.9.2** Parking is provided for cars and motorcycles in accordance with Table 3.9.
- A 3.9.3** Maximum parking provision does not exceed double the minimum number of bays specified in Table 3.9.
- A 3.9.4** Car parking and vehicle circulation areas are designed in accordance with AS2890.1 (as amended) or the requirements of applicable local planning instruments.
- A 3.9.5** Car parking areas are not located within the **street setback** and are not visually prominent from the street.
- A 3.9.6** Car parking is designed, **landscaped** or screened to mitigate visual impacts when viewed from **dwelling**s and private outdoor spaces.
- A 3.9.7** Visitor parking is clearly visible from the **driveway**, is signed 'Visitor Parking' and is accessible from the primary entry or entries.
- A 3.9.8** Parking shade structures, where used, integrate with and complement the overall **building** design and **site** aesthetics and have a low reflectance to avoid glare into **apartments**.
- A 3.9.9** Uncovered **at-grade** parking is planted with trees at a minimum rate of one tree per four bays.
- A 3.9.10** **Basement** parking does not protrude more than 1m above ground, and where it protrudes above ground is designed or screened to prevent negative visual impact on the **streetscape**.

Table 3.9 Parking ratio

Parking types		Location A	Location B
Car parking ¹	1 bedroom dwellings	0.75 bay per dwelling	1 bay per dwelling
	2+ bedroom dwellings	1 bay per dwelling	1.25 bays per dwelling
	Visitor	1 bay per four dwellings up to 12 dwellings 1 bay per eight dwellings for the 13th dwelling and above	
Bicycle parking ¹	Resident	0.5 space per dwelling	
	Visitor	1 space per 10 dwellings	
Motorcycle/ Scooter parking ²	Developments exceeding 20 dwellings provide 1 motorcycle/scooter space for every 10 car bays		

¹ Calculations of parking ratios shall be rounded up to the next whole number.

² For each five motorcycle/scooter parking bays provided in accordance with Table 3.9, car parking bays may be reduced by one bay.

Definitions:

Location A: includes all land located within:

- 800m of a train station on a high-frequency rail route, measured in a straight line from the pedestrian entry to the train station platform to any part of a lot;
- 250m of a high-frequency transit route, or multiple transit routes that if combined have timed stops every 15 minutes during weekday peak periods (7-9am and 5-7pm), measured in a straight line from along any part of the transit route to any part of the lot; and/or
- within the defined boundaries of an activity centre.

Location B: not within Location A.

3 Siting the development

└ 3.9 Car and bicycle parking



Photo 3.9a Open carport structures offer shade and shelter while maintaining good sightlines.



Photo 3.9b Tandem bays can provide increased spatial efficiency.



Photo 3.9c Providing secure, well-integrated bicycle storage is recommended.



Photo 3.9d Car stackers can provide a space-efficient solution.



Photo 3.9e Convenient, secure and undercover parking for bicycles is located next to the entrance of this apartment block.

DESIGN GUIDANCE

Potential alternative solutions to satisfy the Element Objectives will be considered on a performance basis.

- DG 3.9.1** The location, form, quantity and organisation of parking is usually a balance of **development** feasibility, **site** constraints, local context, resident expectations, **apartment** types and regulatory car parking requirements. The provisions of **deep soil areas**, **stormwater** management and tree retention can also affect the size and shape of a car park footprint.
- DG 3.9.2** Parking requirements should be determined considering the proximity of the **development** to a centre(s) and the availability of public parking or **high-frequency** public transport services. Reducing car parking requirements may reduce car dependency and encourage walking, cycling and the use of public transport.
- DG 3.9.3** Visitor parking may be reduced where there is adequate on-**street** parking or public parking in the near vicinity of the **development**.
- DG 3.9.4** The provision of parking for alternative forms of transport such as car share vehicles, motorcycles and bicycles should also be considered.
- DG 3.9.5** Consideration may be given to the reduction of resident parking (including to zero bays) subject to an assessment of the location, the likely current and future demand for parking spaces, the likely impact on neighbouring land uses and whether it is suitable to allow the supply of fewer spaces.
- DG 3.9.6** Options such as tandem parking (where two bays are allocated to one **dwelling**) and car-stackers may also reduce the overall area required for parking.
- DG 3.9.7** Consideration should be given to decoupling resident parking from **dwellings** so that all parking bays can be managed allocated or leased according to need.
- DG 3.9.8** On-**site** parking provision should include:
- provision for motorbikes and scooters
 - secure undercover bicycle parking for residents
 - appropriately located bike **storage** for visitors.
- DG 3.9.9** Detailed design of internal circulation and car parking areas should provide particular attention to:
- safe and **continuous paths of travel** for pedestrians and cyclists, ideally separated but otherwise via differentiating surface treatments, traffic calming devices and appropriate signage to establish a shared use zone
 - in a single width **driveway**, sufficient width for a vehicle to safely pass a pedestrian with child, a cyclist or wheelchair user
 - clear **sightlines** within circulation areas
 - the visibility and accessibility of visitor parking
 - reducing light-spill from headlights and overhead lighting into the **habitable rooms** of **dwellings** within the **development** and adjoining properties
- managing the visual impact, noise, heat absorption and reflective glare associated with long driveways and extensive areas of parking and banks of garage doors.
- DG 3.9.10** Consider electric vehicle charging infrastructure for both resident and visitor bays. When not installing charging stations as part of the **development**, electrical supply and car park distribution board should allow for future capacity to supply electric vehicle charging points at a recommended minimum 20 per cent of total bays.
- DG 3.9.11** For below-ground car parking:
- excavation should be minimised through efficient car park layouts and ramp design
 - where it protrudes above ground, employ design solutions such as stepping car park levels, using split levels on **sloping sites** or design solutions applicable for **at-grade** parking
 - avoid underground car parking in locations with high water tables that require de-watering
 - ventilation grills or **screening** devices for car parking openings should be integrated into the **façade** and **landscape** design of the **development**.
- DG 3.9.12** **At-grade** car parks should be safe, comfortable and **landscaped** environments. Design solutions to achieve this include:
- providing safe and direct access from car parking to **building** entry points
 - incorporating parking into the landscape design of the **site**, by extending planting and materials into the car park space
 - to manage **stormwater** run-off from car park surfaces, the incorporation of tree pits, vegetated swales, bio-filters, infiltration cells, **permeable paving** and/or on-site detention tanks as appropriate
 - using light coloured paving materials or permeable paving systems, and planting shade trees between parking spaces to reduce increased surface temperatures from large areas of paving (refer 4.12 *Landscape design*).
- DG 3.9.13** For above-ground car parking, consider:
- **screening**, **landscaping**, public art and other design elements to integrate the above ground car parking with the **building façade**
 - ‘sleeving’ the car park with active uses along the **street frontage**.

Designing the building

Designing the building provides Element Objectives, Acceptable Outcomes and Design Guidance for building form, layout, functionality, landscape design, environmental performance and residential amenity.

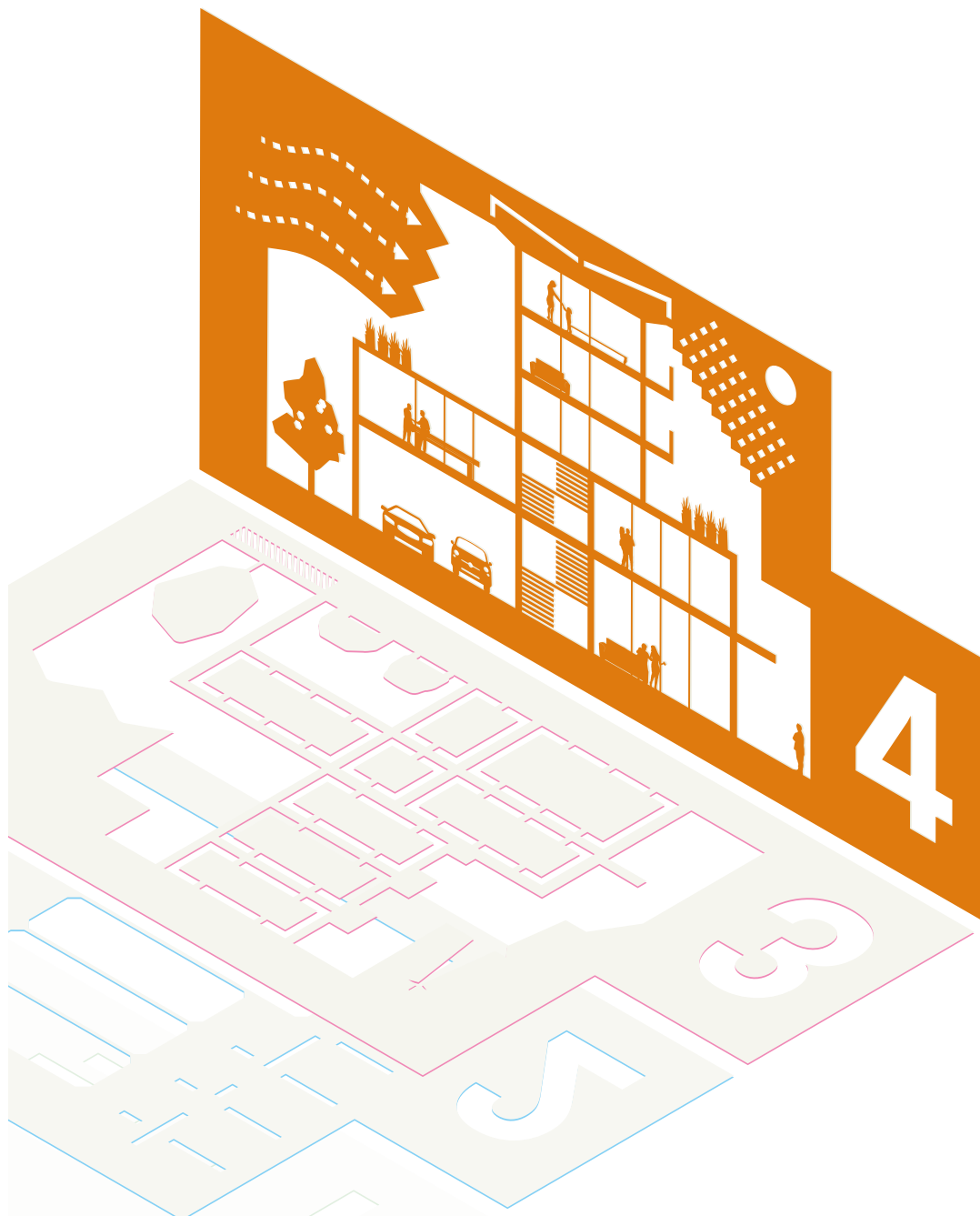

4

4.1	SOLAR AND DAYLIGHT ACCESS	60
4.2	NATURAL VENTILATION	64
4.3	SIZE AND LAYOUT OF DWELLINGS	68
4.4	PRIVATE OPEN SPACE AND BALCONIES	72
4.5	CIRCULATION AND COMMON SPACES	76
4.6	STORAGE	80
4.7	MANAGING THE IMPACT OF NOISE	82
4.8	DWELLING MIX	86
4.9	UNIVERSAL DESIGN	88
4.10	FAÇADE DESIGN	90
4.11	ROOF DESIGN	92
4.12	LANDSCAPE DESIGN	94
4.13	ADAPTIVE REUSE	98
4.14	MIXED USE	100
4.15	ENERGY EFFICIENCY	104
4.16	WATER MANAGEMENT AND CONSERVATION	106
4.17	WASTE MANAGEMENT	108
4.18	UTILITIES	110

Solar and daylight access

▶ Intent

Good, climate sensitive design can contribute to significant reductions in energy consumption through good daylighting, maximising beneficial **solar gain** in winter and reducing solar gain in summer. Regular **daylight** exposure also improves people's sense of well-being.

In temperate **climate zones** adequate access to **sunlight** is therefore an important factor in improving the **amenity** of **dwellings**, whereas in hotter tropical climates minimising direct sunlight and providing shade is required.

As the density and scale of **buildings** and localities increases, access to daylight and winter sun typically decreases.

Development must be sited and designed to optimise **solar** and daylight **access** for dwellings and **open space** considering climatic conditions, both within the development and for adjoining properties and urban spaces.

Related Elements

- 2.2 Building height
- 2.4 Side and rear setbacks
- 2.6 Building depth
- 2.7 Building separation
- 3.2 Orientation
- 4.2 Natural ventilation
- 4.3 Size and layout of dwellings
- 4.15 Energy efficiency

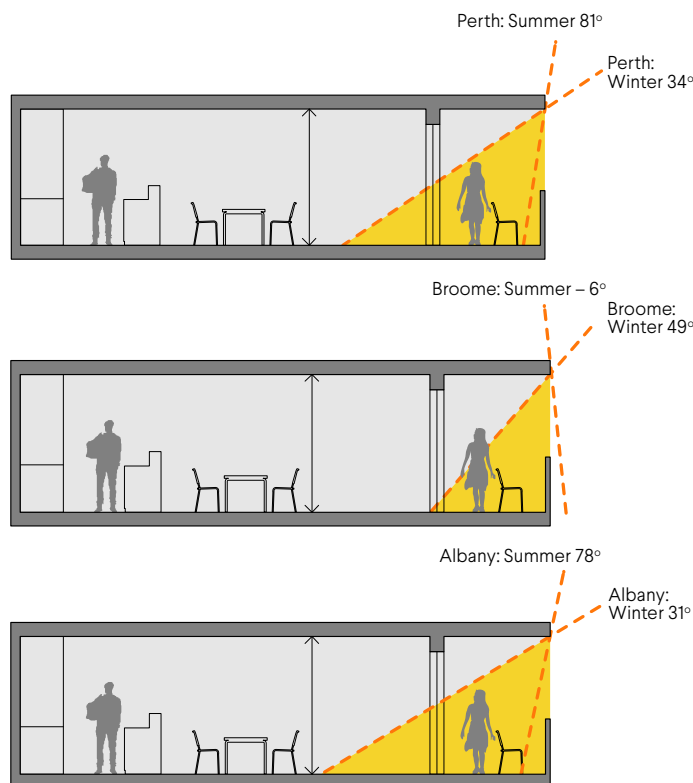

Figure 4.1a Shading devices on balconies should shade summer sun and allow winter sun access to living area. Solar angles vary for Perth, Broome and Albany.

ELEMENT OBJECTIVES

Development is to achieve the following Element Objectives:

- O 4.1.1** In **climate zones 4, 5 and 6**: the **development** is sited and designed to optimise the number of **dwelling**s receiving winter **sunlight** to **private open space** and via windows to **habitable rooms**.
- O 4.1.2** Windows are designed and positioned to optimise **daylight** access for **habitable rooms**.
- O 4.1.3** The **development** incorporates shading and glare control to minimise heat gain and glare:
 - from mid-spring to autumn in **climate zones 4, 5 and 6** **AND**
 - year-round in climate zones 1 and 3.

ACCEPTABLE OUTCOMES

Acceptable Outcomes are likely to assist in satisfying the objectives but are not a comprehensive 'deemed-to-comply' list. In order to achieve the Element Objectives, proposals may require additional and/or alternative design solutions in response to the site conditions, streetscape and design approach.

A 4.1.1 In **climate zones 4, 5 and 6** only:

(a) **Dwellings** with a northern aspect are maximised, with a minimum of 70 per cent of dwellings having living rooms and **private open space** that obtain at least 2 hours direct **sunlight** between 9am and 3pm on 21 June **AND**

(b) A maximum of 15 per cent of dwellings in a **building** receiving no direct sunlight between 9am and 3pm on 21 June.

A 4.1.2 Every **habitable room** has at least one window in an external wall, visible from all parts of the room, with a glazed area not less than 10 per cent of the **internal floor area** and comprising a minimum of 50 per cent of clear glazing.

A 4.1.3 **Lightwells** and/or skylights do not form the primary source of **daylight** to any **habitable room**.

A 4.1.4 The **building** is oriented and incorporates external shading devices in order to:

- minimise direct **sunlight** to **habitable rooms**:
 - between late September and early March in **climate zones 4, 5 and 6** only **AND**
 - in all seasons in climate zones 1 and 3
- permit winter sun to habitable rooms in accordance with A 4.1.1 (a).

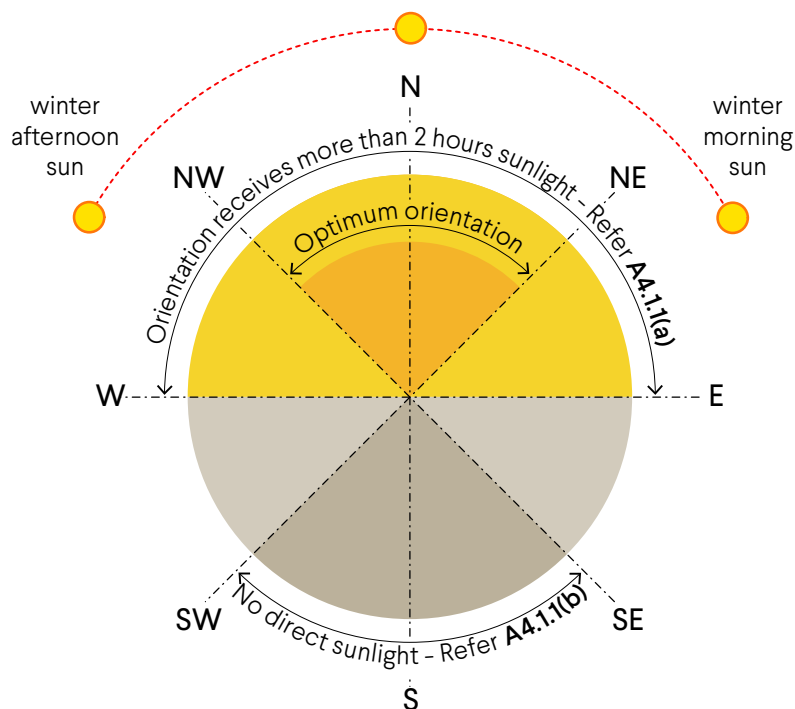

Figure 4.1b The hours of sunlight that can be expected in mid winter are directly related to the orientation of the windows or balconies. To achieve 2 hours sunlight (refer A4.1.1(a)), windows must be facing between west and north; or between north and east. This diagram shows the optimal orientation for sunlight to reach any portion of a window or balcony on 21 June in climate zones 4, 5 and 6.

4 Designing the building

└ 4.1 Solar and daylight access



Photo 4.1a Well sized and oriented glazing brings daylight into open plan spaces. (PC)



Photo 4.1b Optimising daylight access via tall windows/doors that open to a balcony/courtyard and the sky without too much recess or canopy.



Photo 4.1c Louvred balustrades and operable awnings allow residents to adapt the balcony for light or shade throughout the day, as well as controlling shelter and privacy. (PC)



Photo 4.1d Shading and glare-control measures help to moderate solar gain for west-facing windows and balconies, including operable roof louvres to optimise sunlight and shelter.



Photo 4.1e Simple sun shading device can be effective in minimising heat and glare. (PC)



Photo 4.1f Different types of shading elements can adapt to the needs of different internal spaces and orientations. (PC)

DESIGN GUIDANCE

Potential alternative solutions to satisfy the Element Objectives will be considered on a performance basis.

DG 4.1.1 In cooler climates south facing **dwelling**s that receive no direct **sunlight** should be minimised. In tropical areas **winter solar gain** is less critical, however winter sun access on cooler dry mornings can still be beneficial. A more important design consideration in tropical areas is shading to southern and western elevations to protect against mid-summer sun.

DG 4.1.2 Minimum requirements for access to **sunlight** for **habitable rooms** and **private open space** is measured at **mid-winter** (21 June) when passive heating is most beneficial. Providing direct sunlight to **dwelling**s may be optimised through a number of design features such as:

- **dual aspect apartments**
- shallow **apartment** layouts
- two **storey** and **mezzanine** level apartments
- **bay windows**.

DG 4.1.3 Consider strategies to maximise **solar access** to ground floor **apartment**s such as:

- high ceilings and tall windows
- trees and shrubs that allow solar access in winter and shade in summer.

DG 4.1.4 **Daylight** access is optimised when windows are visible from all parts of a **habitable room** and the window has direct access to the sky, rather than being within a deep façade, with overhangs above. Daylight access can also be enhanced through the use of reflected light via **light shelves**, light coloured internal finishes and **higher ceilings**. However care must be taken to avoid unwanted glare effects.

DG 4.1.5 Where there are restrictions on the use of clear glazing to manage impacts on visual privacy, consider design options such as:

- increasing ceiling heights to increase the overall height of the window and light reflectance from the ceiling
- using a window with a lower sill and providing obscure glazing to 1.6m with clear glazing above.

DG 4.1.6 In **climate zones** 4, 5 and 6, shading from summer sun is most required between November to March. Consider pairing shading treatments with high performance glazing and the insulation of external walls to reduce heat transfer into the **dwelling**.

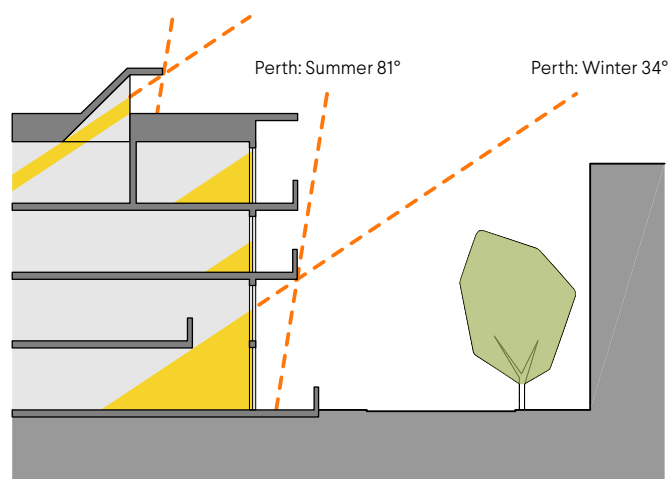

Figure 4.1c Double height apartments and skylights on roofs increase daylight access. Solar angles will vary for different locations in WA.

Natural ventilation

► Intent

Good indoor air-quality is essential for healthy and comfortable living environments, with poor indoor air-quality being a significant contributor to poor respiratory health. In most situations, optimising **natural ventilation** is the most affordable and effective way to manage indoor air quality.

Natural ventilation is the movement of a sufficient volume of fresh air through a **dwelling** to refresh indoor air. It is best achieved by **apartments** that have more than one aspect with direct exposure to the prevailing winds, or with windows located in significantly different pressure regions. The use of natural ventilation also reduces the need for mechanical ventilation and air conditioning.

Considering options for **natural cross ventilation** is best undertaken in the early stages of a project when decisions are being made about **building** orientation and **building depth**, the configuration of apartments and the external **building envelope**. Early consideration complements the more technical requirements of the **NCC** applied at building permit stage.

Related Elements

- 2.4 Side and rear setbacks
- 2.6 Building depth
- 2.7 Building separation
- 4.1 Solar and daylight access
- 4.3 Size and layout of dwellings
- 4.15 Energy efficiency

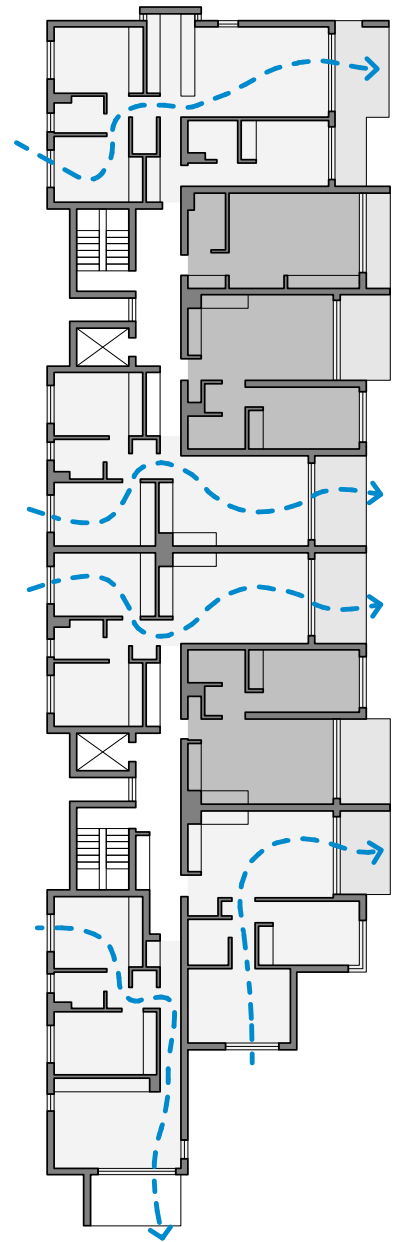

Figure 4.2a Five out of a total of eight apartments in the above example can achieve natural cross ventilation with dual aspects / corner layout. The remaining three single aspect apartments cannot achieve cross ventilation.

ELEMENT OBJECTIVES

Development is to achieve the following Element Objectives:

- O 4.2.1 Development** maximises the number of apartments with natural ventilation.
- O 4.2.2 Individual dwellings** are designed to optimise natural ventilation of habitable rooms.
- O 4.2.3 Single aspect apartments** are designed to maximise and benefit from natural ventilation.

ACCEPTABLE OUTCOMES

Acceptable Outcomes are likely to assist in satisfying the objectives but are not a comprehensive 'deemed-to-comply' list. In order to achieve the Element Objectives, proposals may require additional and/or alternative design solutions in response to the site conditions, streetscape and design approach.

- A 4.2.1 Habitable rooms** have openings on at least two walls with a straight line distance between the centre of the openings of at least 2m.
- A 4.2.2 (a)** A minimum 60 per cent of dwellings are, or are capable of, being naturally cross ventilated in the first nine storeys of the building
 - (b) Single aspect apartments** included within the 60 per cent minimum at (a) above must have:
 - ventilation openings oriented between 45° – 90° of the prevailing cooling wind direction **AND**
 - room depth no greater than $3 \times$ ceiling height
 - (c)** For dwellings located at the 10th storey or above, balconies incorporate high and low level ventilation openings.
- A 4.2.3** The depth of cross-over and cross-through apartments with openings at either end and no openings on side walls does not exceed 20m.
- A 4.2.4** No habitable room relies on lightwells as the primary source of fresh-air.

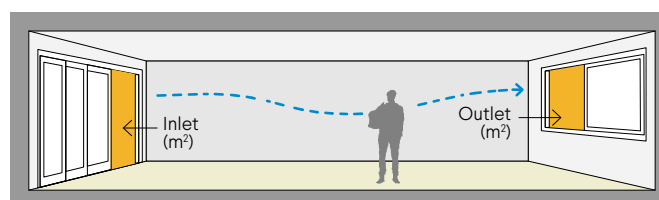
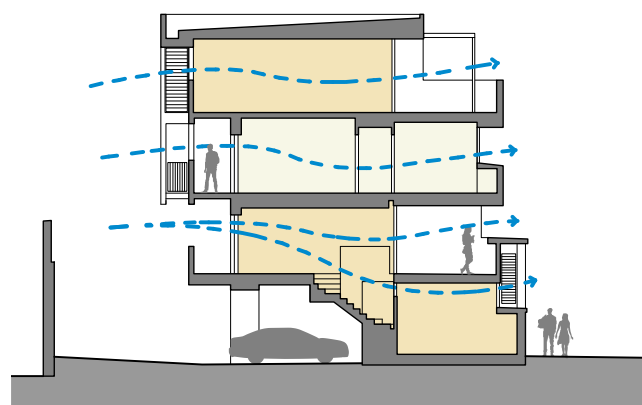

Figure 4.2b Door and window sizes on opposite sides of an apartment influence cross ventilation performance (applicable to cross-through and cross-over apartments).

4 Designing the building

└ 4.2 Natural ventilation



Photo 4.2a Sun screen and pergola structure provide shade and at the same time allow for natural ventilation. (PC)



Photo 4.2b, c & d (From top) Louvre, casement and awning windows are preferred to sliding windows as the latter provide limited opportunity for the control of breeze. (PC)

DESIGN GUIDANCE

Potential alternative solutions to satisfy the Element Objectives will be considered on a performance basis.

DG 4.2.1 Natural ventilation can be achieved by:

- **Natural cross ventilation**, which occurs when **dwellings** have openings with two different orientations so that breeze can flow through the room or **building** to flush out hot or stale air
- passive or buoyancy ventilation, which relies on the effect of rising hot air and requires high and low openings so that warm air is flushed from higher openings and cooler air is drawn in through lower openings.

DG 4.2.2 Optimise the number of **dwellings** with openings oriented in at least two different directions to achieve better **cross ventilation**. The orientation of these openings and the design of **façade** elements and windows can also assist the capture and use of prevailing breezes.

DG 4.2.3 Apartment layout and **building depth** are closely linked with the ability of an apartment to be naturally ventilated. Generally as the **building** gets deeper, effective airflow reduces. Minimising the depth of individual apartments, the length of **enclosed** corridors and overall building depth can improve opportunities for **natural ventilation**.

DG 4.2.4 Sliding windows provide limited opportunity for the control of breeze. Preferable options include casement, awning or louvre windows.

DG 4.2.5 Where the use of entry doors for **cross ventilation** is restricted by security of fire considerations, consider alternative design measures such as **highlight windows**, louvre panels and/or screens to funnel breezes into the **apartment**.

DG 4.2.6 Better **natural ventilation** can be achieved for **single aspect dwellings** by having openings that can be left in an open position on at least two sides of the dwelling to create a breeze path. Consider design solutions such as:

- high and low level ventilation openings oriented between 45° to 90° of the prevailing cooling wind direction
- windows in at least two rooms and connecting doors located at the rear of the room rather than adjacent to the windows
- using **stack effect ventilation/solar chimneys** or wind scoops to naturally ventilate internal **building** areas or rooms such as bathrooms and laundries (particularly in **climate zone 3**)
- designing **courtyards** or building indentations that are open on one side and have a width-to-depth ratio of at least 3:1.

DG 4.2.7 Where sufficient **natural ventilation** cannot be achieved due to constraints such as external noise or poor outdoor air quality, consider providing ventilation by passive **trickle vents**, ceiling fans and/or energy-efficient mechanical air exchange systems. Split system air-conditioners do not provide air exchange or ventilation.

DG 4.2.8 Poor ventilation of wet areas can result in mould growth, a decline in indoor air quality in the entire **dwelling** and may cause **building** fabric to deteriorate. External openable windows should be provided to bathrooms and laundries wherever possible. When this is not possible, consider **trickle vents** in addition to mechanical exhaust systems, and switch mechanical exhaust systems separately from lights so they can be left on when the room is unoccupied.

Size and layout of dwellings

► Intent

Good design ensures that despite having a smaller size, **apartments** have adequate space and efficiency to meet the needs of occupants and their family and friends, and are flexible enough to respond to changing circumstances.

The overall **internal floor area** of the **dwelling** and the dimensions of individual rooms need to be large enough to accommodate differing arrangements of furniture depending on individual preferences and requirements. The arrangement of doors, windows, circulation paths and electrical fittings also needs careful consideration to maximise flexibility and functionality.

Ceiling height also contributes to the perceived spaciousness of interiors. The width, depth and height of rooms should be considered in concert to create well proportioned spaces. Correct proportions can also improve daylighting and facilitate better **natural ventilation** of rooms.

Related Elements

- 4.1 Solar and daylight access
- 4.2 Natural ventilation
- 4.4 Private open space and balconies
- 4.6 Storage
- 4.8 Dwelling mix
- 4.9 Universal design

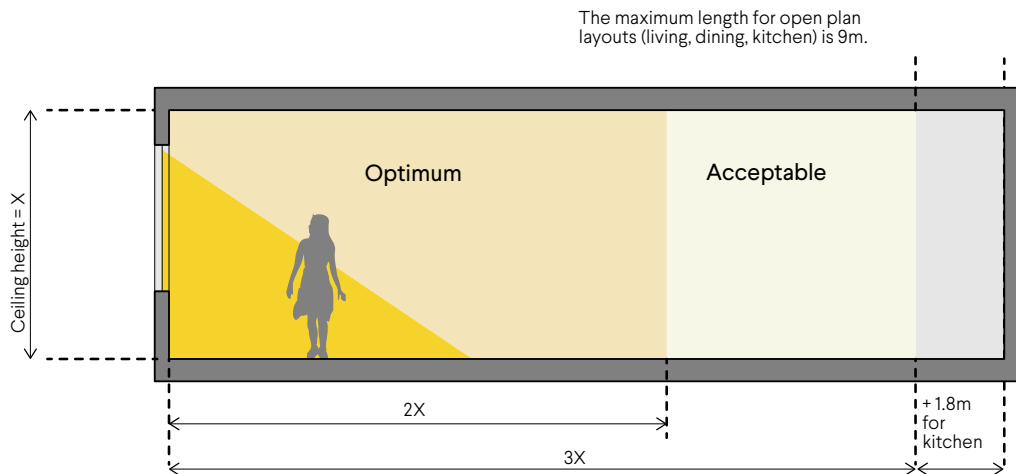

Figure 4.3a The depth of a single aspect apartment relative to the ceiling height directly influences the quality of natural ventilation and daylight access (refer A4.3.4).

ELEMENT OBJECTIVES

Development is to achieve the following Element Objectives:

- O 4.3.1** The internal size and layout of **dwelling**s is functional with the ability to flexibly accommodate furniture settings and personal goods, appropriate to the expected household size.
- O 4.3.2** Ceiling heights and room dimensions provide for well-proportioned spaces that facilitate good **natural ventilation** and **daylight** access.

ACCEPTABLE OUTCOMES

Acceptable Outcomes are likely to assist in satisfying the objectives but are not a comprehensive 'deemed-to-comply' list. In order to achieve the Element Objectives, proposals may require additional and/or alternative design solutions in response to the site conditions, streetscape and design approach.

- A 4.3.1** **Dwellings** have a minimum internal **floor area** in accordance with Table 4.3a.
- A 4.3.2** **Habitable rooms** have minimum **internal floor areas** and dimensions in accordance with Table 4.3b.
- A 4.3.3** Measured from the finished floor level to finished ceiling level, minimum ceiling heights are:
 - **Habitable rooms** – 2.7m
 - **Non-habitable rooms** – 2.4m
 All other ceilings meet or exceed the requirements of the **NCC**.
- A 4.3.4** The length of a **single aspect open plan** living area is equal to or less than 3 x the ceiling height. An additional 1.8m length may be provided for a kitchen, where the kitchen is the furthest point from the window in an open plan living area provided that the maximum length does not exceed 9m.

Table 4.3a Minimum internal floor areas for dwelling types

Dwelling type	Minimum internal floor area
Studio	36m ²
1 bed	47m ²
2 bed × 1 bath ¹	67m ²
3 bed × 1 bath ¹	90m ²
¹ An additional 3m ² shall be provided for designs that include a second or separate toilet, and 5m ² for designs that include a second bathroom.	

Table 4.3b Minimum internal floor areas and dimensions for habitable rooms

Habitable room type	Minimum internal floor area	Minimum internal dimension
Master bedroom	10m ²	1.3m
Other bedrooms	9m ²	1.3m
Living room – studio and 1 bed apartments	N/A	3.6m
Living room – other dwelling types	N/A	4m
¹ Excluding robes		

4 Designing the building

4.3 Size and layout of dwellings

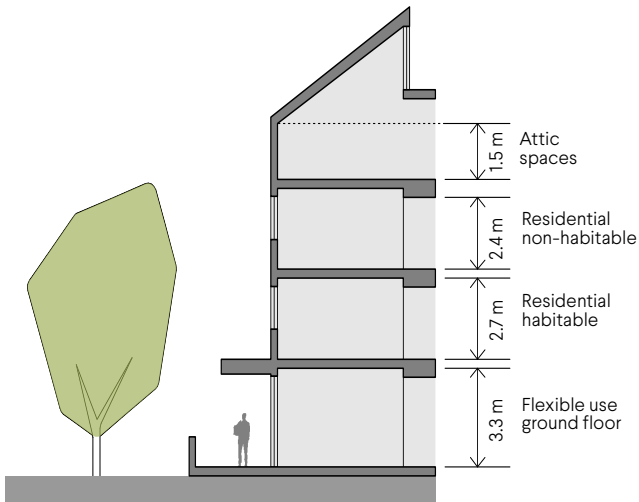

Figure 4.3b Ceiling heights of minimum 2.7m help to achieve good daylight access and natural ventilation to residential apartments.

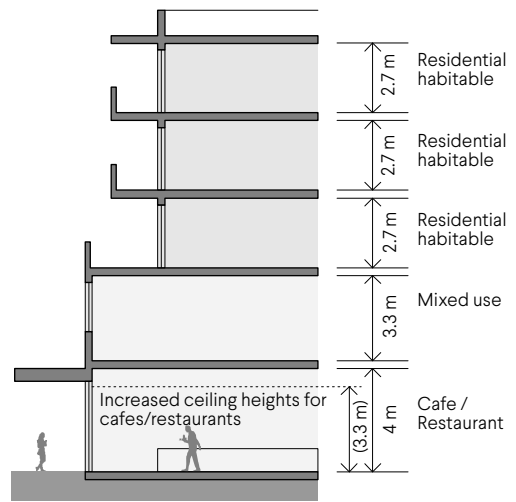

Figure 4.3c Greater than minimum ceiling heights for retail and commercial floors of mixed use developments are encouraged to promote flexibility of use. Cafe and restaurant uses should have ceiling heights of 4m to allow for additional servicing needs.



Photo 4.3a Higher ceilings can make small rooms feel spacious.



Photo 4.3b Bulkheads concealing mechanical services can also serve to delineate spaces in an open plan layout. (PC)

DESIGN GUIDANCE

Potential alternative solutions to satisfy the Element Objectives will be considered on a performance basis.

- DG 4.3.1** People living in **apartments** need spaces that support their lifestyles, with rooms to spend time with family and friends, rooms to seek time alone, and a range of functional spaces for cooking, cleaning, washing and **storage**. Consider layouts that are flexible to accommodate the diverse and changing needs of occupants, including:
- room sizes and dimensions that can accommodate a variety of furniture arrangements, for example, rectangular spaces are often more easily furnished than square spaces
 - prepare design drawings that illustrate potential furniture layouts using realistically sized furniture, including living and dining settings in the living space
 - arranging internal spaces to maximise flexibility and privacy for individual occupants
 - dual-master apartments or **dual key apartments** to provide more flexibility for different household configurations
 - locating living areas and bedrooms on the external face of the **building** to receive **daylight**, with living spaces oriented towards views
 - providing space for robes, typically with a minimum width of 1.8m for the main bedroom and 1.5m for other bedrooms.
- DG 4.3.2** Efficiency of space can be enhanced by co-locating internal circulation areas to maximise the useable area of rooms and improve privacy between different functional areas. Give careful consideration to the location of doors, windows and walls available for furnishing as well as the relationships between different functional spaces. For example, avoid direct access between bedrooms and bathroom via the living room as such access compromises the privacy of these spaces, increases noise transfer and limits the functionality of the living space.
- DG 4.3.3** Consider the size and proportions of rooms to create a sense of spaciousness and maximise daylight penetration. For instance, long, narrow rooms in **cross-over** or **cross-through apartments** require a width of at least 4m.
- DG 4.3.4** Additional ceiling height adds significantly to the sense of space in a **dwelling**. Higher ceilings may also assist with **natural ventilation** and to accommodate ceiling fans for cooling and heat distribution. Given that the overall **building** height is constrained once constructed, provision for additional ceiling height needs to be considered at the planning stage. When choosing ceiling heights, consider:
- introducing changes in ceiling height to give greater definition to spaces within the dwelling
 - locating bulkheads above **non-habitable spaces** such as robes or **storage** areas, to maintain higher ceilings in **habitable space** areas
 - providing more ceiling height to ground floor **street** front units to provide greater flexibility for **adaptive reuse**, for instance if located in mixed use areas, consider providing ceiling heights of 3.3m or more
 - if ceiling heights are constrained, reducing room depth accordingly to compensate for the loss of **daylight** penetration, reduced volume and sense of spaciousness.

Private open space and balconies

► Intent

Well-designed **balconies, terraces** and **courtyards** support indoor-outdoor living options in **apartment buildings**. The appropriate size and configuration of **private open space** will vary according to the urban context, **site** orientation and relationship to views and **landscape**, as well as market demands. Whatever the configuration, private open space should be designed to augment internal living areas and provide flexibility for occupants in their use of internal and external spaces.

Good design will balance the relationship between private open space and interior rooms, give consideration to the aspect, orientation and outlook from the **open space**, and management of its interface with common areas, other **dwellings** and the public realm. The location of private open space also needs to minimise impact on winter **solar access** and **natural ventilation**, as well as consider options for summer shading of **habitable rooms**.

The configuration and detailing of private open space is also a significant design element of building **façades** and can be used in the articulation and materiality of the building to improve **streetscape** outcomes.

Related Elements

- 3.4 Communal open space
- 4.3 Size and layout of dwellings
- 4.12 Landscape design
- 4.18 Utilities



Photo 4.4a Providing generous, covered balconies allows them to be used as living spaces. (PC)



Photo 4.4b Balconies can enhance the amenity of the residents by providing extra space and views. (PC)

ELEMENT OBJECTIVES

Development is to achieve the following Element Objectives:

- O 4.4.1** Dwellings have good access to appropriately sized **private open space** that enhances residential **amenity**.
- O 4.4.2** **Private open space** is sited, oriented and designed to enhance liveability for residents.
- O 4.4.3** **Private open space** and **balconies** are integrated into the overall architectural form and detail of the **building**.

ACCEPTABLE OUTCOMES

Acceptable Outcomes are likely to assist in satisfying the objectives but are not a comprehensive 'deemed-to-comply' list. In order to achieve the Element Objectives, proposals may require additional and/or alternative design solutions in response to the site conditions, streetscape and design approach.

- A 4.4.1** Each **dwelling** has **private open space** accessed directly from a **habitable room** with dimensions in accordance with Table 4.4.
- A 4.4.2** Where **private open space** requires **screening** to achieve visual privacy requirements, the entire **open space** is not screened and any screening is designed such that it does not obscure the outlook from adjacent living rooms.
- A 4.4.3** Design detailing, materiality and **landscaping** of the **private open space** is integrated with or complements the overall **building** design.
- A 4.4.4** Services and fixtures located within **private open space**, including but not limited to air-conditioner units and clothes drying, are not visible from the **street** and/or are integrated into the **building** design.

Table 4.4 Private open space requirements

Dwelling type	Minimum Area ¹	Minimum Dimension ¹
Studio apartment + 1 bedroom	8m ²	2.0m
2 bedroom	10m ²	2.4m
3 bedroom	12m ²	2.4m
Ground floor / apartment with a terrace	15m ²	3m
¹ Services and fixtures located within private open space, including but not limited to air-conditioner units and clothes drying, are not visible from the street and/or are integrated into the building design. When calculating the extent of private open space, exclude servicing areas such as bin storage, clothes drying, air conditioning units and the like.		

4 Designing the building

4.4 Private open space and balconies

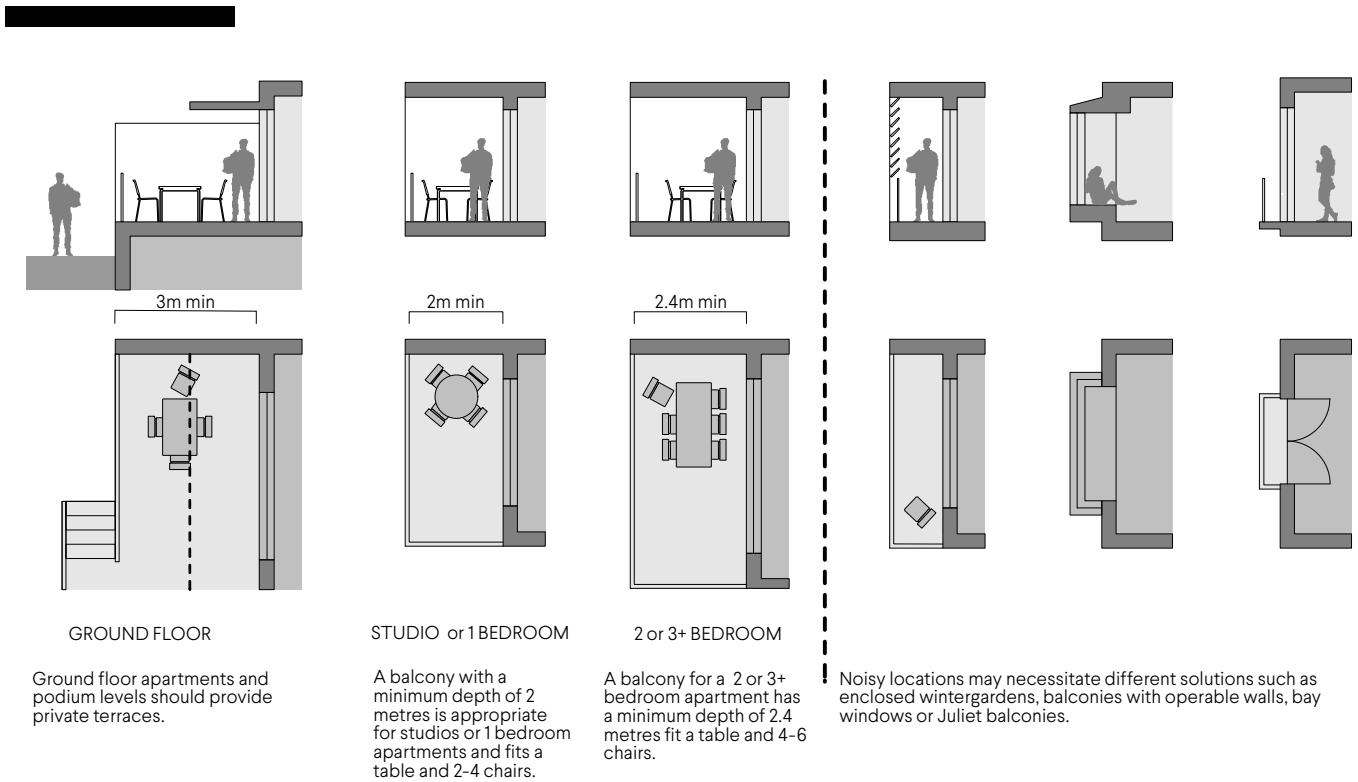

Figure 4.4a Diagrams illustrating minimum balcony depth and options for noise treatment.



Photo 4.4c Apartments with living rooms that extend out to the balcony or terrace are often a preferred layout as it maximises spaces as well as provide dwellers with the feeling of an extended living area. The balcony retains good external outlook to views, landscape and open sky from internal rooms.



Photo 4.4d Operable shutters can be used to control sunlight and wind, as well as enhanced privacy.

DESIGN GUIDANCE

Potential alternative solutions to satisfy the Element Objectives will be considered on a performance basis.

- DG 4.4.1** It is preferable that primary **open space** areas connect and are accessible from, the living room, dining room or kitchen of the **dwelling**.
- DG 4.4.2** The location and size of covered **private open space** should balance the functionality of the outdoor space with the climatic performance and daylighting of internal spaces. The following design solutions can assist with this:
- in temperate **climate zones**, deep covered areas are desirable on east and west faces, and to all faces in climate zones 1 and 3, to maximise shading of living spaces
 - for single fronted **dwelling**s it is preferable that the living room has good **daylight** access and consideration should be given to alternative **balcony** configurations that do not provide deep shade to this room
 - west or east facing **open space** may require additional shading from low angle summer sun. Use **operable screens** or angled blades to admit winter sun
 - locate balconies to the side of living areas (with side access from the room), or consider the use of a pergola or operable awning, to enable **winter solar gain** and **daylight** to living rooms
 - use operable louvres for balconies with high exposure to prevailing winds.
- DG 4.4.3** **Balconies** and **open space** should be designed to retain good external outlook to **landscape**, views or open sky via the balcony from internal rooms. Ideally this means that the outer edge of the **private open space** is open to the sky and visible from the living room. Consider orientation of the balcony to avoid or minimise the need for high **screening** to achieve visual privacy requirements, as this can restrict **daylight** access and outlook for both the open space and adjoining **habitable rooms**.
- DG 4.4.4** **Private open space** should also offer residents reasonable privacy from neighbouring properties and the public realm. The extensive use of transparent balustrading or fencing, such as glass, pool fencing, or a minimum compliance balustrade, at ground floor and lower levels is not ideal as these solutions offer no privacy for residents. Inclusion of opaque or partially obscured fences and balustrades are preferable. This has the additional advantage of **screening** the **storage** of unsightly objects where required.
- DG 4.4.5** In some locations it will not be possible to provide **open space** that has high **amenity** for residents. Examples include **sites** affected by road, rail or aircraft noise, **developments** involving the **adaptive reuse** of existing **buildings**; higher buildings or exposed coastal locations where wind speed restricts the functionality, amenity and safety of outdoor space. In these circumstances consider design solutions such as:
- increasing internal living areas with **bay windows**, **juliet balconies** or **operable walls** opening into narrower open space
 - **enclosed** or semi-enclosed / operable **wintergardens**
 - roof-top **terraces**.
- DG 4.4.6** Where the provision of **private open space** is constrained by other factors, consider providing alternative secondary living spaces and/or increasing the area of **communal open space**. Increasing the area of communal open space commensurate with a decrease in private open space may also be appropriate where there is an explicit intent to facilitate communal living.¹
- DG 4.4.7** Design should also consider the daily useability of **private open space**:
- use **operable screens**, shutters, hoods and pergolas to control **sunlight** and wind access to the **open space** area enabling its use at different times of the day and season
 - consider providing a water tap for plants and a gas outlet for a barbecue to primary **balconies** and private open space
 - make provision for the safety and **amenity** of pets
 - provide additional space where clothes drying, **storage** or air conditioning units are located in private open space, **screening** these **utilities** from the **street** and integrating them in the **building** design
 - condenser units should exhaust away from not into the private open space. Consider co-locating these items so that the exhaust assists with clothes drying
 - set back balustrades from the building or balcony edge where overlooking or safety is an issue.
- DG 4.4.8** Integrate **balconies** and **private open space** into the overall form and aesthetic of the **development**. For example:
- projecting balconies should be integrated into the **building** design and the design and finish of **soffits** considered
 - **operable screens**, shutters, hoods and pergolas should complement the materiality of the building
 - downpipes and balcony drainage should be integrated with the **façade** and building design
 - locate air-conditioning units on roofs, in **basements** or storerooms, or fully integrate them into the building design. Exposed pipework or outdoor units should not be visible from the **street**.

¹ Examples may include student housing, supported housing, co-operative housing, 'Nightingale' projects, Baugruppen and the like.

Circulation and common spaces

► Intent

Entries, lifts, stairs, corridors and **walkways** are the stage, and opportunity, for everyday interactions between **apartment** residents. Good design of these spaces, and the interface with **dwelling**s, is essential to facilitate the casual interactions between residents that foster a sense of community.

In addition to circulation spaces, the provision of well-designed communal facilities and spaces, that provide residents with options for socialising, exercise or hobbies, will also add to the communal life, engagement and well-being of residents within the **development**.

Circulation and common spaces should meet **universal access** requirements and be designed with consideration of their functionality, safety, security and **amenity**, as well as the potential impacts on dwelling units and neighbours.

Related Elements

- 3.4 Communal open space
- 3.7 Pedestrian access and entries
- 4.9 Universal design



Photo 4.5a Well appointed communal facilities in this common area combined with circulation space enhance the amenity of this apartment development. (PC)



Photo 4.5b & c Use of different materials and textures along circulation spaces can create interest and enhance user experience. (PC)

ELEMENT OBJECTIVES

Development is to achieve the following Element Objectives:

- O 4.5.1** Circulation spaces have adequate size and capacity to provide safe and convenient access for all residents and visitors.
- O 4.5.2** Circulation and common spaces are attractive, have good **amenity** and support opportunities for social interaction between residents.

ACCEPTABLE OUTCOMES

Acceptable Outcomes are likely to assist in satisfying the objectives but are not a comprehensive 'deemed-to-comply' list. In order to achieve the Element Objectives, proposals may require additional and/or alternative design solutions in response to the site conditions, streetscape and design approach.

- A 4.5.1** Circulation corridors are a minimum 1.5m in width.
- A 4.5.2** Circulation and common spaces are designed for **universal access**.
- A 4.5.3** Circulation and common spaces are capable of **passive surveillance**, include good **sightlines** and avoid opportunities for concealment.
- A 4.5.4** Circulation and common spaces can be illuminated at night without creating light spill into the **habitable rooms** of adjacent **dwellings**.
- A 4.5.5** Bedroom windows and major openings to living rooms do not open directly onto circulation or common spaces and are designed to ensure visual privacy and manage noise intrusion.

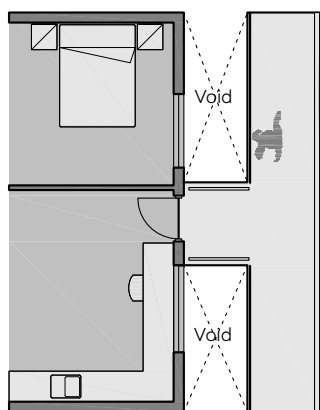
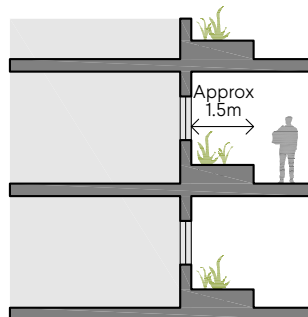
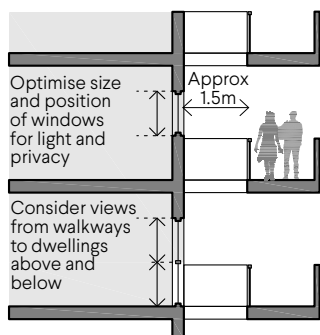

Structural separation of common walkway from habitable rooms

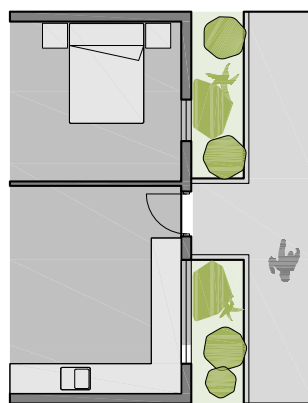

Planter bed creates a buffer between walkway and habitable rooms

Figure 4.5a A range of design responses to maintaining comfortable separation between open gallery accessways and apartments.

4 Designing the building

└ 4.5 Circulation and common spaces



Photo 4.5d Communal walkway is separated by a void from dwelling windows to provide some degree of privacy.



Photo 4.5e Combining circulation pathway with communal open space makes outdoor areas integral to resident experience. (PC)



Photo 4.5f The roof and floors in the middle section of this adaptive reuse of a heritage building have been removed to allow for better natural ventilation and light to reach the circulation area. (PC)

DESIGN GUIDANCE

Potential alternative solutions to satisfy the Element Objectives will be considered on a performance basis.

- DG 4.5.1** The configuration of circulation and common spaces is an important consideration in the early planning phase, as these areas are used by all residents on a daily basis and inform the first impression of visitors. The design of circulation spaces is therefore critical in defining the character, style and **amenity** of the **development**.
- DG 4.5.2** **Universal access** is a mandatory requirement of contemporary **building** design for all publicly accessible places. In the context of an **apartment development** this means circulation areas and common spaces must be **universally accessible** via a **continuous path of travel** from the primary entry.
- DG 4.5.3** Design considerations to ensure safe and convenient access for all users of these spaces are listed below:
- provide secure access to circulation areas, including intercoms for residents to admit visitors
 - consider limiting the number of **dwelling**s served by a single **circulation core** to no more than 12 on a floor
 - consider providing an additional lift when the number of dwellings serviced by a single lift exceeds 40, or when the travel distance between a single dwelling and a lift exceeds 50m
 - provide short, straight **sightlines** by minimising corridors lengths and avoiding tight corners between the circulation core and individual dwellings
 - for corridors or galleries with a length of more than 18m (or six entry doors) use changes in height, width, materials or lighting to reduce the apparent length of the corridor and improve **amenity**
 - design and locate fire escape stairs so they can be used as an attractive and functional alternative to the lift, particularly for residents on lower floors, having regard to fire safety requirements
 - provide low-level of constant light overnight and motion sensors for additional lighting when activated, including directional control of lighting to prevent light spill into dwellings
 - include legible signage for **apartment** numbers, common areas and general wayfinding
 - design and material selection for the prevention of slips, trips and falls; for example, handrails to assist elderly users, the use of slip resistant floor finishes in external and semi **enclosed** circulation spaces, including stairs, and weather protection at dwelling entries.
- DG 4.5.4** The design of circulation spaces should contribute to making **dwelling** entries distinct and private. This can be achieved by offsetting entry doors, creating an entry vestibule or varying ceiling height, width and materials in the corridor to create a 'porch'. In external galleries consider offsetting the dwelling entries from the gallery with an entry court, while avoiding creating spaces for concealment.
- DG 4.5.5** Windows of **dwellings** should not open directly onto circulation and common spaces. Use physical separation, **screening**, acoustic glazing, **landscaping**, lighting design and other devices to minimise impacts and to maintain privacy in the dwelling.
- DG 4.5.6** Good design can greatly enhance the **amenity** of circulation and common spaces. Consider design solutions such as:
- maximising **daylight** and **natural ventilation** to circulation and common spaces to improve amenity and thermal performance, and reduce operational costs
 - incorporating additional width or height in corridors and at entry lobbies, lifts and **dwelling** entries to create a sense of spaciousness and enable the movement of furnishings and bulky goods, for instance, the width of lift landings should exceed the depth of the lift car
 - providing seating in foyers and other breakout spaces within circulation and common spaces
 - where external galleries are provided, making these more open than closed above the balustrade
 - using materials, colours and lighting that create an attractive and welcoming environment.
- DG 4.5.7** Communal facilities: In larger **developments**, consider providing common spaces and rooms for a variety of activities and uses, such as facilities for the shared preparation of food, gardening and craft groups, mother's groups and children's play groups, as well as strata or resident meetings. Ideally these spaces will be co-located with **communal open space**. In some cases it might be appropriate to provide public access to promote connection with the wider community, but the safety and **amenity** of residents must be maintained.

Storage

► Intent

Apartment sizes vary but in general they are a compact **dwelling** type and need to be designed for particular efficiency. Providing dedicated **storage** space can help to preserve living spaces, reduce the need for off-site storage and enable residents to pursue their hobbies and lifestyle choices.

Site planning and apartment design should include provision for storage proportionate to the size of dwellings and capable of accommodating larger items. Storage should be secure, fit for purpose, weatherproof and safely and easily accessed.

Related Elements

- 4.3 Size and layout of dwellings



Photo 4.6a Storage cabinets are integrated at the entrances of the dwelling units in this development, making them convenient to use, easily accessible and more secured.



Photo 4.6b This storage area is integrated into the balcony design, weatherproof and screened from view.

ELEMENT OBJECTIVES

Development is to achieve the following Element Objectives:

- O 4.6.1** Well-designed, functional and conveniently located **storage** is provided for each **dwelling**.

ACCEPTABLE OUTCOMES

Acceptable Outcomes are likely to assist in satisfying the objectives but are not a comprehensive 'deemed-to-comply' list. In order to achieve the Element Objectives, proposals may require additional and/or alternative design solutions in response to the site conditions, streetscape and design approach.

- A 4.6.1** Each **dwelling** has exclusive use of a separate, ventilated, weatherproof, bulky goods **storage** area. This can be located either internally or externally to the dwelling with dimensions in accordance with Table 4.6.
- A 4.6.2** Bulky good stores that are not directly accessible from the **dwelling/private open space** are located in areas that are convenient, safe, well-lit, secure and subject to **passive surveillance**.
- A 4.6.3** **Storage** provided separately from **dwelling**s or within or adjacent to **private open space**¹, is integrated into the design of the **building** or **open space** and is not readily visible from the **public domain**.

¹ Storage on/adjacent to private open space is additional to required open space area and dimensions.

Table 4.6 Storage requirements

Dwelling type	Storage area ¹	Minimum dimension ¹	Minimum height ¹
Studio dwelling	3m ²	1.5m	2.1m
1 bedroom dwelling	3m ²		
2 bedroom dwellings	4m ²		
3 bedroom dwellings	5m ²		

¹ Dimensions exclusive of services and plant.

DESIGN GUIDANCE

Potential alternative solutions to satisfy the Element Objectives will be considered on a performance basis.

- DG 4.6.1** Given the reliance on storerooms for the secure **storage** of personal goods in **apartment development**, best practice is to ensure that storerooms are ventilated, protected from the weather and free from moisture ingress to provide dry and mould free storage. This can be achieved by:
- integrating the storeroom into the main **building**
 - installing fixed vents in the walls and door
 - painting or rendering single leaf masonry walls
 - providing moisture protection under the slab and/or waterproofing to retaining walls.
- DG 4.6.2** Store rooms can be convenient places for the location of services, but this should not be at the cost of valuable **storage** space, or ease of maintenance access. If services are located in the storeroom, consider:
- locating A/C condenser units at a height that retains storage functionality below
 - locating electrical distribution boards/switchboards adjacent to the door so they are readily accessible for maintenance and power outages
 - increasing the size of the store room.
- DG 4.6.3** Consider providing wall mounted bicycle mounts in storerooms to retain **storage** functionality below and to reduce the requirement for common area bicycle racks.
- DG 4.6.4** **Storage** areas should be wide enough to accommodate larger and less frequently accessed items.
- DG 4.6.5** **Storage** space in internal or **basement** car parks is best positioned at the rear or side of car spaces or in cages, so that allocated car parking remains accessible and that storage can be accessed even when a car is in the bay.
- DG 4.6.6** If communal **storage** is provided, it should be additional to the minimum requirements for individual **dwelling**s at A4.6.1 and easily accessed from common circulation areas.
- DG 4.6.7** Storerooms that are not attached to a primary **building** should:
- not exceed 5 per cent of the **site area**
 - be separated into buildings each with an **internal floor area** not greater than 60m²
 - have a wall height not greater than 2.4m
 - have a roof ridge line not greater than 4.2m
 - be set back behind the **primary** or **secondary street frontage**
 - comply with side and rear boundary **setback** requirements.

Managing the impact of noise

➤ Intent

Given the number of people living in close proximity in an **apartment building**, management of noise transfer within the **development** and between **dwellings** is critical to maintain **amenity** and limit disturbances between neighbours. Noise impacts from external sources, such as major roads, rail service, flight paths or entertainment venues, should also be managed.

Responding to these factors in the siting, orientation and initial planning of the development can assist in finding cost-effective strategies to mitigate noise impacts and achieve better amenity for residents.

The **NCC** stipulates performance requirements for managing structure-borne sound. However, evidence suggests these requirements do not manage noise levels to the satisfaction of occupants. This element identifies design initiatives that aim to exceed these minimum requirements to provide better long term outcomes for residents.

Related Elements

- 2.7 Building separation
- 4.17 Waste management
- 4.18 Utilities

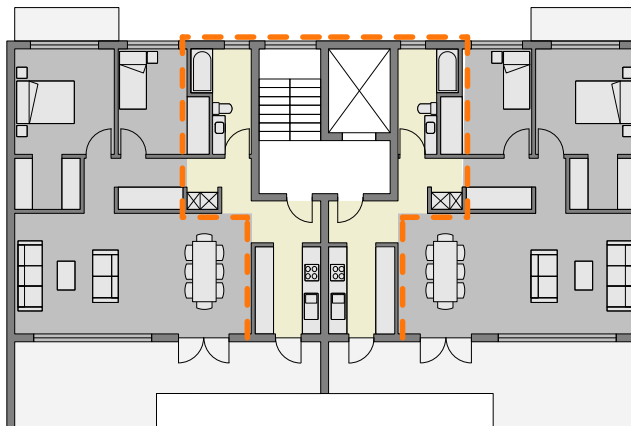

Figure 4.7a The building layout should protect living areas and bedrooms from impacts of noise by avoiding adjacency between living spaces and the noisy circulation core. (Example floorplan only)

ELEMENT OBJECTIVES

Development is to achieve the following Element Objectives:

- O 4.7.1** The siting and layout of **development** minimises the impact of external noise sources and provides appropriate **acoustic privacy** to **dwellings** and **on-site open space**.
- O 4.7.2** Acoustic treatments are used to reduce sound transfer within and between **dwellings** and to reduce noise transmission from external noise sources.

ACCEPTABLE OUTCOMES

Acceptable Outcomes are likely to assist in satisfying the objectives but are not a comprehensive 'deemed-to-comply' list. In order to achieve the Element Objectives, proposals may require additional and/or alternative design solutions in response to the site conditions, streetscape and design approach.

- A 4.7.1** **Dwellings** exceed the minimum requirements of the **NCC**, such as a rating under the **AAAC Guideline for Apartment and Townhouse Acoustic Rating** (or equivalent).
- A 4.7.2** Potential noise sources such as garage doors, **driveways**, **service areas**, plant rooms, **building services**, mechanical equipment, active **communal open space** and refuse bins are not located adjacent to the external wall of **habitable rooms** or within 3m of a window to a bedroom.
- A 4.7.3** Major openings to **habitable rooms** are oriented away or shielded from external noise sources.

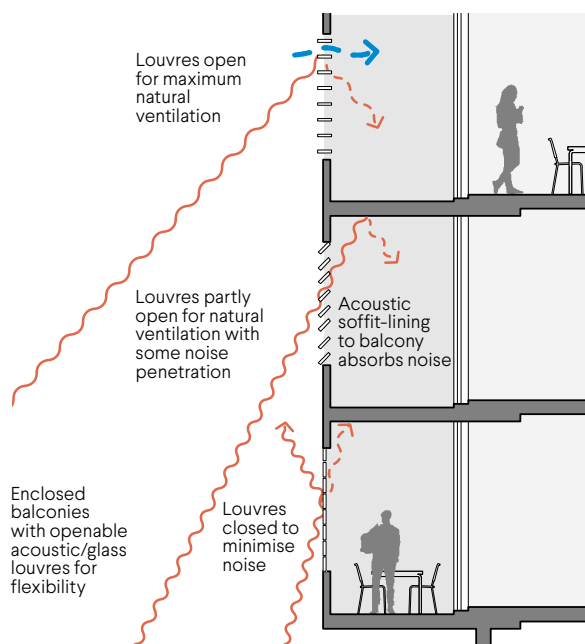

Figure 4.7b Enclosed balconies or 'wintergardens' can mitigate site noise impacts such as major road and rail corridors.

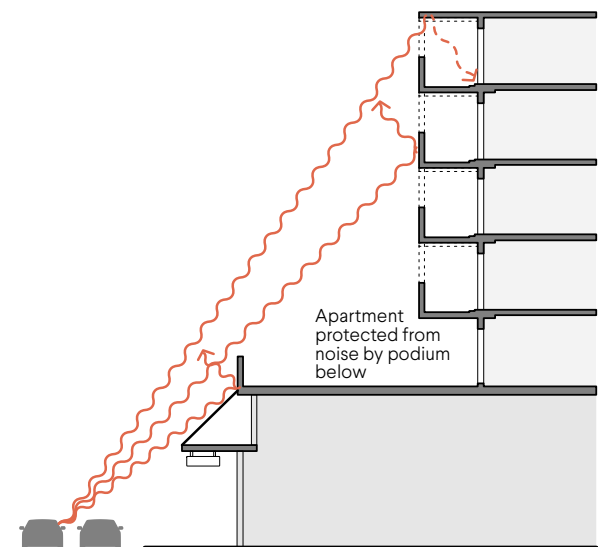

Figure 4.7c Setting back the residential component above a podium helps shield apartments from major noise. Balcony soffits can be treated with sound absorption to assist noise mitigation.

4 Designing the building

└ 4.7 Managing the impact of noise



Photo 4.7a By considering noise sources in the orientation of the building and the design of façades and windows, good living conditions can be achieved even in close proximity to noise sources.



Photo 4.7b Development next to a freeway needs sufficient noise abatement measures such as those listed in DG 4.7.3. (See also Photo 4.7c, showing some of the noise reduction features in the same building).



Photo 4.7c Sliding sash glazing and louvre windows in this winter garden enables modulation of enclosure and openness, at the same time reduces the impact of traffic noise from the adjacent freeway. Installation of special noise absorbing ceiling material also helps in noise reduction.

DESIGN GUIDANCE

Potential alternative solutions to satisfy the Element Objectives will be considered on a performance basis.

DG 4.7.1 Strategies to manage noise need to be balanced with requirements for **solar** and **daylight access**, **natural ventilation** and **streetscape** objectives. This might require compromise to optimise these various requirements. When considering possible solutions, the primary objective is to create high quality living environments that respond to the existing neighbourhood context or, in an area undergoing transformation, the planned character of the area. In busy urban areas, this will require design solutions that have regard for established noise sources to reduce conflict between future residents and existing land owners. The following strategies may assist in managing external noise impacts on the **development**:

- maximise the distance between significant external noise sources and **habitable rooms** and **private open space**
- orient residential uses away from or perpendicular to the noise source
- where practical, use non-residential **buildings** and lower floor commercial tenancies as an acoustic barrier, ideally sited parallel with the noise source or configured as a **podium** to shield residential uses and **open space** areas
- where solar access is taken from the same direction as the noise source, use double glazing to obtain winter solar access and daylight
- while trees and **landscaping** do not physically reduce sound transmission, they may reduce the perceived level of noise.

DG 4.7.2 The siting and orientation of **buildings** and activities within the **site** can make a major contribution to reducing sound transmission between **dwellings**. Consider:

- maximising the separation between buildings and activities on site and to neighbouring buildings/adjacent uses. The building separation requirements (refer 2.7) provide a starting point
- co-locating noisy areas within buildings (such as entries and corridors) and cluster quieter activity areas, such as locating bedrooms next to or above each other
- using doors to separate different noise zones within dwellings and the building
- locating **storage**, circulation areas and **non-habitable rooms** to buffer noise to **habitable rooms**

- treating wet areas as per habitable rooms in terms of acoustic insulation to prevent the transfer of noise from these areas to habitable rooms within the dwelling.
- locating living areas and bed rooms away from noise sources such as lifts, communal stairwells, mechanical equipment and communal bin stores
- designing active **communal open spaces** to project sound away from bedroom windows.

DG 4.7.3 In environments where managing the impacts of external noise is particularly challenging, (such as **development** adjacent to major roads, rail services, flight paths or entertainment venues) and spatial solutions are not effective, noise conflicts can be managed by more direct intervention such as:

- limiting the number and size of openings facing noise sources
- using acoustic glazing, double glazing and/or acoustic louvres and acoustic seals to doors and windows
- using materials with high sound reduction properties, with preference to high mass materials
- utilising sound-absorbing materials in **balconies** to reduce sound transmission into the **dwelling** and the amplification of sound from **private open space** into the development
- the use of **wintergardens** adjacent to the external noise source where some external aspect is required or desirable
- installing acoustic walling to boundaries.

Dwelling mix

► Intent

Apartments are becoming a more common housing option for a wide variety of households. As demand grows, there is an increasing need for greater choice in the size, layout and design of individual apartments to meet the diverse needs of occupants and ensure that West Australians view apartments as an attractive and practical housing option.

Dwelling mix is a measure of diversity in a **development**, considering factors such as number of bedrooms, bedroom/bathroom ratio, accessibility, dwelling size, quality, price-point and design for children. Development should include a mix of dwelling types and formats suited to local demographics, household types, affordability considerations and local housing options.

Dwelling mix can be informed by historical information such as census data and residential sales history, but is expected to respond to strategic planning for the locality such as the **local planning strategy**, local housing strategy and other applicable local planning instruments.

Related Elements

- 4.3 Size and layout of dwellings
- 4.9 Universal design

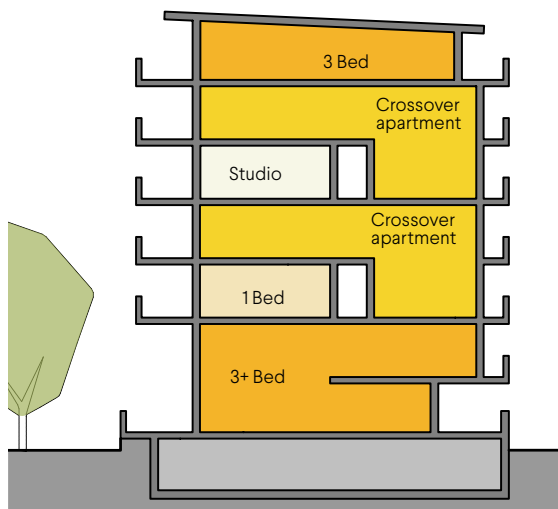

Figure 4.8a Large apartments are often located on the ground or roof level due to opportunities for increased private open space. Internal common circulation (e.g. corridors) can be reduced by adding crossover apartments to the mix.

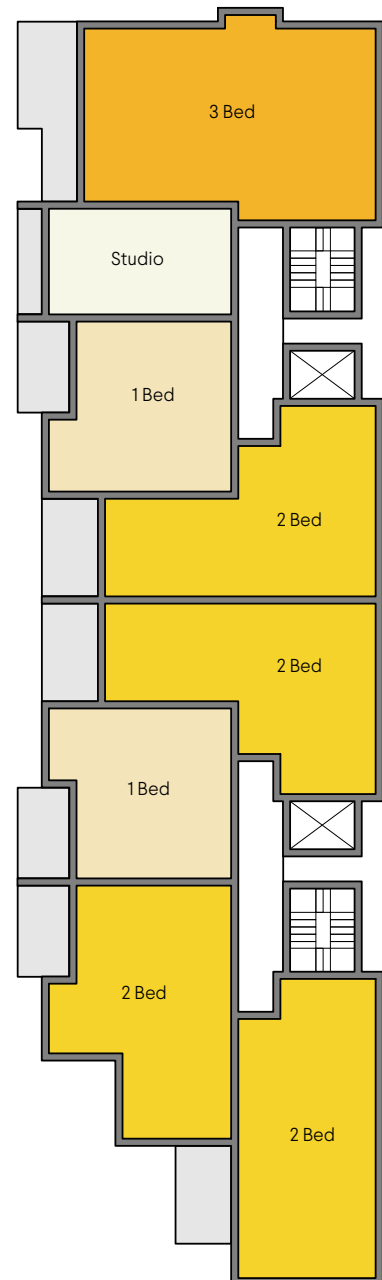

Figure 4.8b A variety of apartments can be accommodated within a floor plate.

ELEMENT OBJECTIVES

Development is to achieve the following Element Objectives:

- O 4.8.1** A range of **dwelling** types, sizes and configurations is provided that caters for diverse household types and changing community demographics.

ACCEPTABLE OUTCOMES

Acceptable Outcomes are likely to assist in satisfying the objectives but are not a comprehensive 'deemed-to-comply' list. In order to achieve the Element Objectives, proposals may require additional and/or alternative design solutions in response to the site conditions, streetscape and design approach.

- A 4.8.1 (a)** Dwelling mix is provided in accordance with the objectives, proportions or targets specified in a local housing strategy or relevant local planning instrument **OR**

(b) Where there is no local housing strategy, **developments** of greater than 10 dwellings include at least 20 per cent of **apartments** of differing bedroom numbers.

- A 4.8.2** Different **dwelling** types are well distributed throughout the **development**, including a mix of dwelling types on each floor.

DESIGN GUIDANCE

Potential alternative solutions to satisfy the Element Objectives will be considered on a performance basis.

- DG 4.8.1** When considering the preferred **dwelling** mix appropriate to the **development** location, take into consideration:
- objectives and demographic trends identified in a local housing strategy or other relevant local planning instrument
 - current and projected community demographics, the profile of existing housing stock and market data
 - employment, education and community services in the locality and the housing demand associated with those services
 - unmet housing need in the locality including a demand for affordable or **accessible** housing.
- DG 4.8.2** A diverse **dwelling** mix may include dwellings designed to suit singles, couples, unrelated adult sharers, families, multi-generation households, seniors ageing in place and people with disabilities. Consider flexible configurations of space that can respond to changes in household composition and work/life arrangements. Examples include:
- increased provision of **adaptable/accessible** dwellings
 - larger rooms that are generic in form and suited to a variety of uses and functions
 - dual master bedroom **apartments** with separate bathrooms
 - dwellings with a **street** front room suited for use as a home business
 - larger apartments with multiple living spaces
 - **open plan, 'loft'** style apartments with only a fixed kitchen, laundry and bathroom to accommodate temporary partitioning of space by occupants
 - larger apartments with access to larger outdoor **courtyards** or **terraces** to meet the needs of families.
- DG 4.8.3** Ground floor **dwellings** are particularly suited to assist with providing greater housing diversity. Good accessibility means they are also well suited to aged or disabled occupants who require **adaptable** or **universally designed** dwellings.

Universal design

► Intent

The Disability Services Commission describes **universal design** as being the:

“creation of building, products and environments that are usable and effective for everyone, to the greatest extent possible without the need for adaptation or specialised design.”

One-in-five Australians live with disability and by 2020 almost 10 per cent of the WA population will be aged 70 years or older. This correlates to increasing demand for **dwellings** that incorporate design features to accommodate the needs of people with limited mobility.

Universal design dwellings include additional features that are more adaptable to the changing needs of occupants, and that may be difficult and expensive to retrofit. In practice, the inclusion of these features improves the functionality of housing for all users, regardless of age or ability.

Universal design considerations also apply to access throughout a **development**. *The Disability Standards (Access to Premises – Buildings) 2010* require the provision of **universal access** to public places which includes common circulation and communal areas within an **apartment** development. Universal access requirements are incorporated in the relevant elements of this policy.

Related Elements

- 3.4 Communal open space
- 3.6 Public domain interface
- 3.7 Pedestrian access and entries
- 4.3 Size and layout of dwellings
- 4.5 Circulation and common spaces
- 4.8 Dwelling mix



Photo 4.9a A step-free entrance is provided in this apartment block, taking into consideration universal access.

ELEMENT OBJECTIVES

Development is to achieve the following Element Objectives:

- O 4.9.1 Development** includes **dwelling**s with **universal design** features providing dwelling options for people living with disabilities or limited mobility and/or to facilitate ageing in place.

ACCEPTABLE OUTCOMES

Acceptable Outcomes are likely to assist in satisfying the objectives but are not a comprehensive 'deemed-to-comply' list. In order to achieve the Element Objectives, proposals may require additional and/or alternative design solutions in response to the site conditions, streetscape and design approach.

- A 4.9.1 (a)** 20 per cent of all dwellings, across a range of **dwelling** sizes, meet Silver Level requirements as defined in the *Livable Housing Design Guidelines* (Livable Housing Australia) **OR**
- (b)** 5 per cent of dwellings are designed to Platinum Level as defined in the *Livable Housing Design Guidelines* (Livable Housing Australia).

DESIGN GUIDANCE

Potential alternative solutions to satisfy the Element Objectives will be considered on a performance basis.

- DG 4.9.1** The National Disability Insurance Scheme has adopted the *Livable Housing Design Guidelines* as a benchmark for accessibility and this is recommended as the appropriate benchmark for considering **universal design** under this policy. The Guidelines incorporate a list of required inclusions to achieve Silver, Gold or Platinum standard housing. These include features such as a step-free threshold, generous door and passage widths, provision for the future installation of grab rails and increasing the minimum size of wet areas.
- DG 4.9.2** Platinum Level **dwelling**s are recommended to include two bedrooms, or a secondary studio bedroom space, to provide the option for carer accommodation.
- DG 4.9.3** Consider the provision of parking bays appropriate to the particular type of **universal** and **adaptable dwelling**s provided in the **development**.

Façade design

➤ Intent

The design of the **façade** is the most prominent expression of the design of a **building** to its surroundings. When a new building is introduced into a **streetscape**, it should reference the proportions, rhythms and scale that define the character of the streetscape or adjacent built form, while introducing new design elements that enhance the visual interest and **amenity** of the public realm.

Good façades demonstrate a well-conceived and coherent design that integrates all elements of the building, from articulation of different uses and form through to scale, materiality, the integration of services and the inclusion of detail elements. Good façades enhance the **legibility** of the building at the **street** and include elements that improve pedestrian amenity.

Related Elements

- 4.11 Roof design
- 4.18 Utilities



Photo 4.10a A 'twist' at the corner creates an interesting play on the strong geometrical lines of the façade, highlighting the corner of the building.

Photo 4.10b, c & d Differentiating detailing and materials helps to articulate building form. (PC)

ELEMENT OBJECTIVES

Development is to achieve the following Element Objectives:

O4.10.1 Building façades incorporate proportions, materials and design elements that respect and reference the character of the local area.

O4.10.2 Building façades express internal functions and provide visual interest when viewed from the public realm.

ACCEPTABLE OUTCOMES

Acceptable Outcomes are likely to assist in satisfying the objectives but are not a comprehensive 'deemed-to-comply' list. In order to achieve the Element Objectives, proposals may require additional and/or alternative design solutions in response to the site conditions, streetscape and design approach.

A4.10.1 Façade design includes:

- scaling, articulation, materiality and detailing at lower levels that reflect the scale, character and function of the public realm
- rhythm and visual interest achieved by a combination of **building** articulation, the composition of different elements and changes in texture, material and colour.

A4.10.2 In **buildings** with height greater than four **storeys**, **façades** include a defined base, middle and top for the building.

A4.10.3 The **façade** includes design elements that relate to key **datum lines** of adjacent **buildings** through upper level **setbacks**, **parapets**, **cornices**, awnings or colonnade heights.

A4.10.4 **Building** services fixtures are integrated in the design of the **façade** and are not visually intrusive from the public realm.

A4.10.5 **Development** with a primary **setback** of 1m or less to the **street** includes awnings that:

- define and provide weather protection to entries
- are integrated into the **façade** design
- are consistent with the **streetscape** character.

A4.10.6 Where provided, signage is integrated into the **façade** design and is consistent with the desired **streetscape** character.

DESIGN GUIDANCE

Potential alternative solutions to satisfy the Element Objectives will be considered on a performance basis.

DG 4.10.1 Good **façade** design can be achieved by consideration of some of the following design solutions:

- use of materials, openings, awnings and design details at the **street** level that have a human scale, with proportions that are appropriate to the **streetscape**
- well defined entries that are integrated into the overall design of the **façade** and streetscape and provide **legibility** and **amenity** for users
- coherent and balanced composition of **building** elements to achieve scale, texture and rhythm, including expression of horizontal or vertical elements to reference existing streetscape patterns
- changes in texture, material, detail and colour to achieve a finer grained scale
- use of building articulation to animate the **façade** with changing light and shadows throughout the day
- variation in floor heights to define the building base and enhance the human scale
- grouping of floors or elements such as **balconies**, windows and shading devices on taller buildings to add visual interest and texture
- defining corners through articulation of the building or roof, or changes in height, materials and colour.

DG 4.10.2 The design and siting of awnings should consider:

- location at all **building** entries to define the entry and provide weather protection
- integration of awnings into the **façade** design and **streetscape**, and the relationship to residential windows, **balconies** and **street** infrastructure
- continuous awnings over busy footpaths, including on secondary **frontages** for corner **sites**
- material selection for durability, maintenance, shade, glare, acoustic reverberation and weather protection
- **rainwater** collection and discharge to prevent discharge onto pedestrian areas below.

DG 4.10.3 Legible **building** design can minimise the extent of signage needed at **street** level. Where required, signage should be integrated with the design of the **façade** to assist wayfinding, complementing the scale, proportion and detailing of the **development**.

DG 4.10.4 Early consideration needs to be given to integrating or concealing **building** services and fixtures within the overall **façade** design such that they do not detract from the appearance of the building from the **street**.

DG 4.10.5 Consider **façade** design measures to minimise bird-window collision, such as exterior visual markers or framing to interrupt expanses of glass, and use of shades or awnings.

Roof design

► Intent

Apartment buildings can be a prominent part of the urban skyline. Considered design of the roof and 'top' of the building is an important element of the overall design and can contribute significantly to **local identity** and wayfinding.

Roof space can also be used to enhance building **amenity** and **sustainability** through use as **open space**, increasing the total area of **landscape** on the **site** or accommodating photovoltaic panels and other sustainability infrastructure.

Related Elements

- 2.2 Building height
- 3.4 Communal open space
- 4.10 Façade design
- 4.12 Landscape design
- 4.18 Utilities



Photo 4.11a Open space, landscaping and other amenity provisions are maximised on these roof and balcony spaces.



Photo 4.11b A communal garden on the roof. (PC)



Photo 4.11c The roof line of this development mimics the original building's roof structure.

ELEMENT OBJECTIVES

Development is to achieve the following Element Objectives:

- O4.11.1** Roof forms are well integrated into the **building** design and respond positively to the **street**.
- O4.11.2** Where possible, roof spaces are utilised to add **open space, amenity**, solar energy generation or other benefits to the **development**.

ACCEPTABLE OUTCOMES

Acceptable Outcomes are likely to assist in satisfying the objectives but are not a comprehensive 'deemed-to-comply' list. In order to achieve the Element Objectives, proposals may require additional and/or alternative design solutions in response to the site conditions, streetscape and design approach.

- A4.11.1** The roof form or top of **building** complements the **façade** design and desired **streetscape** character.
- A4.11.2** **Building** services located on the roof are not visually obtrusive when viewed from the **street**.
- A4.11.3** Useable roof space is safe for users and minimises overlooking and noise impacts on private **open space** and **habitable rooms** within the **development** and on adjoining **sites**.

DESIGN GUIDANCE

Potential alternative solutions to satisfy the Element Objectives will be considered on a performance basis.

- DG 4.11.1** Design solutions to achieve a roof design that complements the **façade** and **streetscape** can include:
 - prominent elements at the **street frontage** and/or corners
 - skillion or very low pitch hipped roofs
 - reducing roof height and mass through the use of smaller elements
 - use of generous eaves and overhangs that assist with shading
 - roof form and/or materials that complement adjacent **buildings**
 - concealed roofs.
- DG 4.11.2** In higher density settings, roofs are often overlooked by, and may overlook, other **buildings**. In these cases the design of the roof/top of building should consider minimising impacts on visual **amenity**, such as reflectivity and the appearance of rooftop services. Service and access elements such as lift overruns and AC plant should be integrated into the roof design, with special consideration of the position, alignment, materials and the use of **screening** to minimise visual prominence when viewed from the **street** or adjacent buildings.
- DG 4.11.3** Consider opportunities to increase light and ventilation to upper level **dwellings** and dwellings located within the roof cavity via dormer or **clerestory** windows and openable skylights.
- DG 4.11.4** Useable roof spaces can make a major contribution to the **amenity** and **sustainability** of the **development**. Options may include:
 - providing **private** or **communal open space** that incorporates measures to mitigate visual and **acoustic privacy** to **dwellings** within the development and on adjacent properties, while providing access to views
 - rooftop garden beds, **landscaping** and **green roofs**
 - provision of photovoltaic collector panels, considering optimum solar collection angle for the roof
 - other sustainability infrastructure.

Landscape design

► Intent

Good **landscape** design integrates **apartment development** with the existing ecology, enhances natural systems and contributes to tree canopy and biodiversity in the locality. It should improve the **street** presence of the development and the **amenity** of pedestrians and **building** occupants, through the creation of attractive **open space**, connection to nature, opportunities for food production, provision of shade and micro-climate benefits. The inclusion of landscape elements is therefore an important aspect of apartment design even in highly-urbanised environments.

Landscape design incorporates the design of **deep soil areas**, other open space and planting areas located on structures such as **podiums, terraces**, walls and roofs. Developments that include landscape design of adjacent verges and open space should also consider the Objectives of this Element.

Related Elements

- 3.3 *Tree canopy and deep soil areas*
- 3.4 *Communal open space*
- 4.4 *Private open space and balconies*
- 4.11 *Roof design*
- 4.16 *Water management and conservation*



Photo 4.12a Well considered landscape design can add significant amenity to communal areas. (PC)



Photo 4.12b Planting along internal courtyard walls can help create a shaded, attractive space.

ELEMENT OBJECTIVES

Development is to achieve the following Element Objectives:

- O4.12.1 Landscape** design enhances **streetscape** and pedestrian **amenity**; improves the visual appeal and comfort of **open space areas**; and provides an attractive outlook for **habitable rooms**.
- O4.12.2** Plant selection is appropriate to the orientation, exposure and **site** conditions and is suitable for the adjoining uses.
- O4.12.3 Landscape** design includes water efficient irrigation systems and, where appropriate, incorporates water harvesting or water re-use technologies.
- O4.12.4 Landscape** design is integrated with the design intent of the architecture including its built form, materiality, key functional areas and **sustainability** strategies.

ACCEPTABLE OUTCOMES

Acceptable Outcomes are likely to assist in satisfying the objectives but are not a comprehensive 'deemed-to-comply' list. In order to achieve the Element Objectives, proposals may require additional and/or alternative design solutions in response to the site conditions, streetscape and design approach.

- A4.12.1** Submission of a **landscape** plan prepared by a competent landscape designer. This is to include a species list and irrigation plan demonstrating achievement of Waterwise design principles.
- A4.12.2 Landscaped** areas are located and designed to support mature, shade-providing trees to **open space** and the public realm, and to improve the outlook and **amenity** to **habitable rooms** and open space areas.
- A4.12.3** Planting on **building** structures meets the requirements of Table 4.12.
- A4.12.4 Building** services fixtures are integrated in the design of the **landscaping** and are not visually intrusive.

Table 4.12 Planting on structure: minimum soil standards for plant types and sizes

Plant type	Definition	Soil volume	Soil depth	Soil area
Large tree	Over 12m high, crown spread at maturity	76.8m ³	1,200mm	64m ² with minimum dimension 7m
Medium tree	8-12m high, crown spread at maturity	36m ³	1,000mm	36m ² with minimum dimension 5m
Small tree	4-8m high, crown spread at maturity	7.2m ³	800mm	3m × 3m
Small ornamentals	3-4m high, crown spread at maturity	3.2m ³	800mm	2m × 2m
Shrubs	--	--	500-600mm	--
Ground cover	--	--	300-450mm	--
Turf	--	--	200mm	--

4 Designing the building

└ 4.12 Landscape design



Photo 4.12c Landscaping on structure creates useful open space. (PC)



Photo 4.12d Planting between dwellings and public footpath provides a soft and attractive interface.



Photo 4.12e Well established and well-maintained planters on structure make communal areas attractive and inviting.



Photo 4.12f Greening of blank walls can add attractiveness to a place.



Photo 4.12g Larger planting beds above an underground car park provide larger areas of greenery and creates a more lush landscaped environment.



Photo 4.12h The corner of this site is used to establish a well landscaped area which contributes to the streetscape amenity.

DESIGN GUIDANCE

Potential alternative solutions to satisfy the Element Objectives will be considered on a performance basis.

- DG 4.12.1** As a general principle **landscape** design should respond to existing **site** and environmental conditions, taking advantage of views, topography, soil profiles and significant existing landscape features such as existing trees and drainage patterns.
- DG 4.12.2** Planting should feature a mix of shade trees (refer Tables 3.3a and 3.3b and Table 4.12, hardy shrubs, ground covers/understorey and native and endemic species.
- DG 4.12.3** **Landscape** design should be environmentally sustainable, considering local environmental conditions and constraints. Consider:
- diverse and appropriate plant selection, preferring the use of native or endemic species or non-invasive, Waterwise plants
 - minimising the use of turf unless sustainable water harvesting and reuse systems are used
 - vegetated **stormwater** management systems and passively irrigated gardens
 - space and equipment for composting
 - use of sub-surface irrigation and irrigation systems with rain and soil moisture sensors
 - opportunities to harvest and re-use **rainwater** collected and stored on-site
 - maximising the use of **permeable surfaces** to allow infiltration of rainwater and irrigation
 - eco-zoning and hydro-zoning to minimise irrigation needs
 - providing water efficient garden beds for residents to plant vegetables and herbs. Food production areas can require specific micro-climate, soil and maintenance requirements, so ensure that the type of garden and species can grow in the given conditions.
- DG 4.12.4** Where the local government supports verge greening, consider including a mix of trees and low native ground covers that provide both shade and soil cover without obscuring visibility for **street** users. While this approach should minimise the need for ongoing irrigation, consider irrigation needs to enable establishment and periodic watering to maintain plant health. Avoid the use of turf and other irrigation-intensive plants.
- DG 4.12.5** **Landscape** design can play an important role in enhancing the micro-climate and improving the thermal performance of **buildings**. Strategies may include:
- designing the landscape to suit winter and summer sun positions, consider existing shading and the direction of prevailing winds
 - providing a balance of evergreen and deciduous trees to provide shading in summer and **sunlight** access in winter
 - **green roofs** or **green walls/façades** and other vertical greening strategies that shade and cool the **building**
 - utilising materials with high reflectivity, low heat conductivity and capacity and high moisture capacity
 - shade structures such as pergolas in **open space**
 - closed system water features that can cool through evaporation.
- DG 4.12.6** Planting on structures can be a viable **landscaping** alternative on constrained or highly urbanised **sites**. These constructed environments require particular technical expertise for their implementation and ongoing maintenance. When considering planting on structures, have regard for the following:
- planter requirements should be established early to ensure structures are reinforced to deal with additional saturated soil weight
 - plant species should be selected with care to ensure they can survive and thrive in intended conditions. Major considerations may include:
 - selection for species for heat resistance, drought and wind tolerance
 - capability of withstanding seasonal changes in **solar access**
 - plant longevity
 - appropriate soil profile and volume should be provided to facilitate good plant growth. Consider:
 - modifying depths and widths according to the planting mix and irrigation frequency
 - use of free draining soils
 - choose soils with a long life span
 - providing sufficient volume to enable tree anchorage
 - account for irrigation and for drainage pathways to reduce staining and ongoing maintenance of the planting infrastructure and the **building** fabric.
- DG 4.12.7** All gardens require maintenance. Allocate an area for this to be undertaken and allow the **storage** of gardening equipment.

Adaptive reuse

► Intent

Adapting existing structures for new uses is a statement of appreciation for the value and significance of historical layering in the built fabric. Typical opportunity **sites** include former industrial **buildings**, **heritage** buildings and underutilised commercial buildings. **Adaptive reuse** can be motivated simply by the utilisation of an existing structure for economy and efficiency, but more often reuse is motivated by the unique character or spatial qualities offered by an existing structure.

The reuse of structures can provide **sustainability** benefits, saving on demolition and the requirement for new materials and embedded energy costs for rebuilding. Retaining and rejuvenating local landmarks and heritage buildings also makes a major contribution to enhancing **local character** and **identity**.

Configuring new **apartments** within existing buildings will involve adaptation and sometimes compromise relative to some elements of this policy, but the result can be very liveable and unique apartments. Achieving a balanced outcome between adaptive reuse and residential **amenity** should be a special focus for design reviewers and decision-makers when considering adaptive reuse proposals.



Photo 4.13a Additional levels of apartments reinforce characteristics of the existing heritage building while remaining modern and distinct.



Photo 4.13b Heritage building fabric can be reinterpreted in unexpected ways in adaptive reuse projects, making unique and site-specific outcomes.

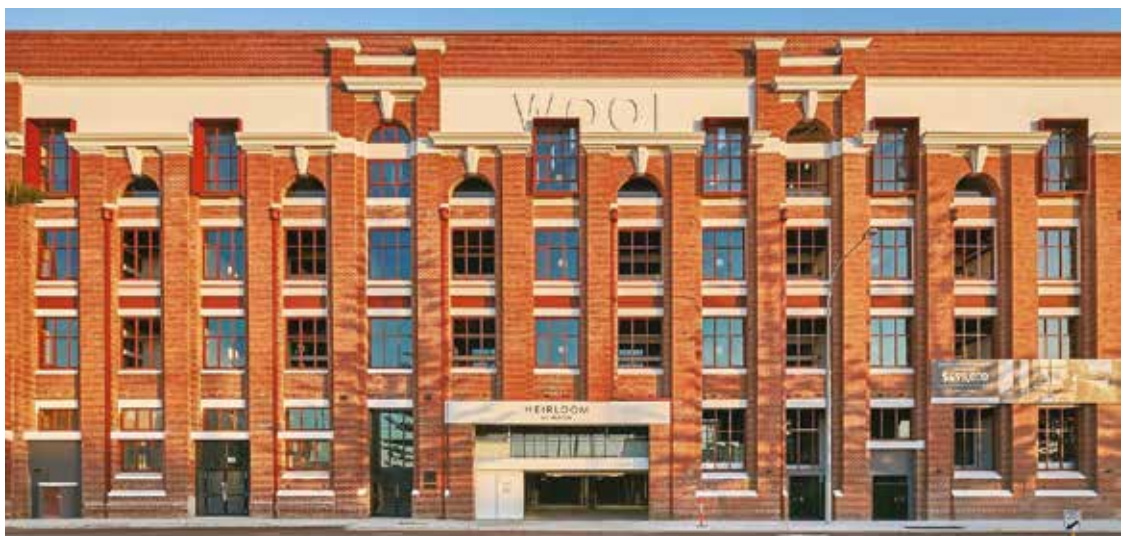

Photo 4.13c This adaptive reuse project protects the heritage and character of the old Woolstores building and turned it into 183 apartment units. (PC)

ELEMENT OBJECTIVES

Development is to achieve the following Element Objectives:

- O4.13.1** New additions to existing **buildings** are contemporary and complementary and do not detract from the character and scale of the existing building.
- O4.13.2** Residential **dwellings** within an adapted **building** provide good **amenity** for residents, generally in accordance with the requirements of this policy.

ACCEPTABLE OUTCOMES

Acceptable Outcomes are likely to assist in satisfying the objectives but are not a comprehensive 'deemed-to-comply' list. In order to achieve the Element Objectives, proposals may require additional and/or alternative design solutions in response to the site conditions, streetscape and design approach.

- A4.13.1** New additions to **buildings** that have **heritage** value do not mimic the existing form and are clearly identifiable from the original building.
- A4.13.2** New additions complement the existing **building** by referencing and interpreting the scale, rhythm and materiality of the building.

DESIGN GUIDANCE

Potential alternative solutions to satisfy the Element Objectives will be considered on a performance basis.

- DG4.13.1** Where **dwellings** in **adaptive reuse** proposals cannot satisfy the acceptable outcomes or design guidance recommendations of this policy due to the limitations of the existing **building**, applicants should demonstrate that the overall **amenity** and performance of dwellings still meets the objectives. Typical residential standards that require greater flexibility in adaptive reuse proposals include:
- **habitable room** depths and ceiling heights
 - alternative approaches to **natural ventilation** and daylighting
 - alternatives **landscape** approaches where **deep soil areas** cannot be achieved
 - **open space** and circulation areas
 - visual and **acoustic privacy**
 - car-parking provision.
- DG4.13.2** Design features to maximise **dwelling amenity** within the constraints of an existing **building** should be applied sensitively. Suggested design approaches include:
- generously-sized voids, atriums, **lightwells**, roof lights and **courtyards** in deeper buildings to improve **daylight** penetration and ventilation
 - utilising available ceiling height to increase daylight and sense of space.
- DG4.13.3** Design solutions to ensure additions are respectful to the existing **building** may include:
- highlight and make good use of the special qualities and features of the existing building
 - design new works to complement the character, siting, scale, proportion, pattern, form, detailing and **landscaping** of the existing building and surrounds
 - use contemporary and complementary materials, finishes, textures and colours to distinguish new elements from the existing building.
- DG4.13.4** The character and **heritage** value of some **buildings** may be protected within the **local planning framework**, *Heritage of Western Australian Act 1990*, *Heritage Act 2018* or Commonwealth legislation. Refer to the requirements of these planning instruments, regulations and legislation in developing schemes for the **adaptive reuse** of affected buildings.

Mixed use

► Intent

Mixed use development is a common feature of higher density areas and centres. Most commonly this takes the form of retail/commercial uses on the ground or lower floors of a **development** with residences above.

The inclusion of retail/commercial uses can complement residential development by providing services and potential employment for residents and by increasing the amount of activity in the neighbourhood. Increased activity improves the liveliness of the **street** at different times of the day and night and increases opportunities for **passive surveillance**.

Successful mixed use development requires careful planning and design to optimise the beneficial synergies with residential development, while managing the potential impacts between these distinct land uses.

Related Elements

- 2.3 *Street setbacks*
- 3.6 *Public domain interface*



Figure 4.14a This mixed use development activates the public domain, while providing a level of separation for residents on the upper levels.

ELEMENT OBJECTIVES

Development is to achieve the following Element Objectives:

- O4.14.1 Mixed use development** enhances the **streetscape** and activates the **street**.
- O4.14.2** A safe and secure living environment for residents is maintained through the design and management of the impacts of non-residential uses such as noise, light, odour, traffic and waste.

ACCEPTABLE OUTCOMES

Acceptable Outcomes are likely to assist in satisfying the objectives but are not a comprehensive 'deemed-to-comply' list. In order to achieve the Element Objectives, proposals may require additional and/or alternative design solutions in response to the site conditions, streetscape and design approach.

- A4.14.1** Where **development** is located within a mixed use area designated within the **local planning framework**, ground floor units are designed for future adaption to non-residential uses.
- A4.14.2** Ground floor uses including non-commercial uses, such as **communal open space, habitable rooms, verandahs and courtyards** associated with ground floor **dwellings**, address, enhance and activate the **street**.
- A4.14.3** Non-residential space in **mixed use development** is accessed via the **street frontage** and/or primary entry as applicable.
- A4.14.4** Non-residential tenancies provided in **mixed use development** has sufficient provision for parking, waste management, and amenities to accommodate a range of retail and commercial uses in accordance with the requirements of the **local planning framework**.
- A4.14.5** **Mixed use development** is designed to mitigate the impacts of non-residential uses on residential **dwellings**, and to maintain a secure environment for residents.

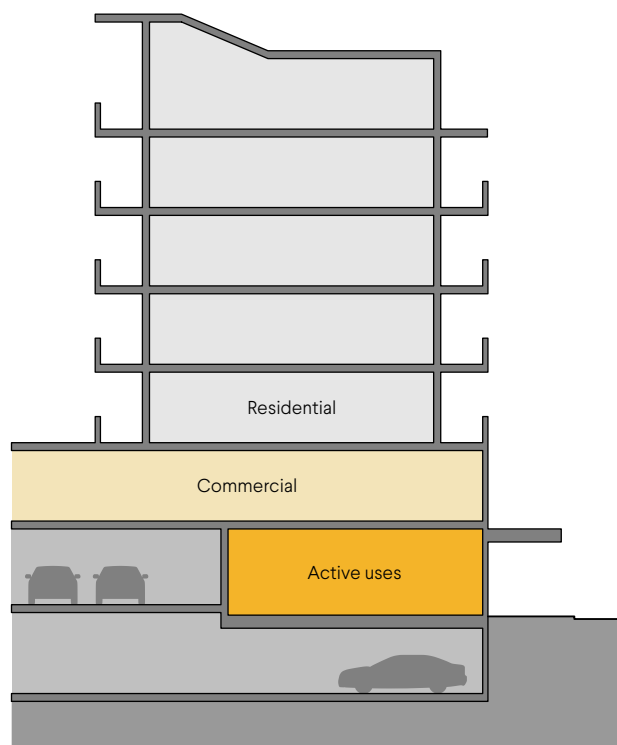

Figure 4.14a Commercial floors are an appropriate buffer between residential apartments and busy active ground floor uses such as cafes.

4 Designing the building

└ 4.14 Mixed use



Photo 4.14 b & c The design expresses the change of use at ground level, while still integrating with the rest of the façade. (PC)



Photo 4.14d, e & f Mixed use development should maximise retail and commercial use at ground level to encourage diverse activities and uses. (PC)

DESIGN GUIDANCE

Potential alternative solutions to satisfy the Element Objectives will be considered on a performance basis.

DG4.14.1 One of the desirable outcomes of **mixed use development** is better activation of the **street**. This can be achieved by considering design solutions that enhance the **streetscape** such as:

- **development** addresses the street and is directly accessed from the street
- flexible and adaptable design that can attract diverse range of activities and be adapted over time to different uses
- street **frontages** are well-articulated and include a mix of solid wall and glazing that allow interaction between the street and the interior
- providing live-work **apartments** at ground floor rather than commercial uses.

DG4.14.2 Where **development** is located within a mixed use area designated within the **local planning framework**, ground floor units should be designed for future adaption to non-residential uses, such as by increased floor to floor heights and ensuring **universal access** requirements can be met.

DG4.14.3 The design of **mixed use development** should include the necessary infrastructure to support business activity. Applicants should review the **local planning framework** to see if there are any applicable requirements that apply to non-residential uses beyond the scope of this policy. Some design considerations include:

- provision of **universal access** to the premises
- vehicle access for deliveries
- providing sufficient staff and customer parking
- inclusion of amenities for staff and customers, such as toilets.

DG4.14.4 The inclusion of non-residential uses in a residential **development** requires additional consideration to manage the potential impacts between these land uses. Design solutions that can assist in mitigating impacts include:

- residential entries being separated from commercial entries and clearly distinguishable
- design of the **building frontage** includes **CPTED** principles, including being well-lit and avoiding places for concealment
- separating commercial service and waste storage areas from residential components
- residential car parking and communal facilities can be accessed securely and exclusively by residents and their guests
- noisy areas within the non-residential uses are oriented away from major openings of **dwellings** and/or shielded with sound attenuation solutions
- air-conditioning and mechanical ventilation equipment for non-residential uses is sited and designed to maintain acceptable noise levels within dwellings
- exhaust from non-residential uses is vented away from dwellings
- lighting for non-residential uses does not directly impact residential dwellings.

Energy efficiency

➤ Intent

As energy demand and costs rise, so does the imperative to reduce the energy consumption of all **dwelling**s, with benefits for residents, the community and the environment. Good design can deliver energy efficient dwellings that are attractive, healthy, and comfortable. Air-conditioning, water heating and lighting account for the majority of energy use in a typical **apartment**. Early design decisions to improve thermal performance and select energy efficient fixtures can therefore have a significant impact on energy use.

This element requires **development** to include at least one energy initiative to assist in reducing energy consumption and responding to our changing energy environment.

Related Elements

- 4.1 Solar and daylight access
- 4.2 Natural ventilation



Photo 4.15a This apartment development fully utilises the roof with the installation of photo-voltaic arrays to supplement the power consumption of the dwelling units. (PC)

ELEMENT OBJECTIVES

Development is to achieve the following Element Objectives:

- O4.15.1** Reduce energy consumption and greenhouse gas emissions from the **development**.

ACCEPTABLE OUTCOMES

Acceptable Outcomes are likely to assist in satisfying the objectives but are not a comprehensive 'deemed-to-comply' list. In order to achieve the Element Objectives, proposals may require additional and/or alternative design solutions in response to the site conditions, streetscape and design approach.

- A4.15.1 (a)** Incorporate at least one significant energy efficiency initiative within the **development** that exceeds minimum practice (refer Design Guidance) **OR**
- (b)** All **dwelling**s exceed the minimum NATHERS requirement for **apartments** by 0.5 stars.¹

¹ Compliance with the NCC requires that development shall achieve an average star-rating across all dwellings that meets or exceeds a nominated benchmark, and that each unit meets or exceeds a slightly lower benchmark. Compliance with this Acceptable Outcome requires that each unit exceeds that lower benchmark by at least half a star.

DESIGN GUIDANCE

Potential alternative solutions to satisfy the Element Objectives will be considered on a performance basis.

DG4.15.1 Examples of energy efficient initiatives that exceed current minimum practice are provided below. Applicants are encouraged to propose other innovative solutions where supported by evidence demonstrating how minimum practice is exceeded:

- ceiling fans to all **habitable rooms**
- hot water systems that are more energy efficient than electric storage units
- provision of an external clothesline to every **dwelling**, located in an area out of direct view on an external wall or in a breezeway
- use of a photovoltaic array for communal services
- installation of a lift with regenerative braking
- solar powered lighting of external **open space**, circulation areas and common spaces.

DG4.15.2 Strategies to improve the NATHERS rating of individual **dwelling**s can include:

- maximising dwellings with northerly orientation and opportunities for **natural ventilation** (refer 4.1 Solar and daylight access and 4.2 Natural ventilation for further guidance)
- achieving effective shading from summer sun
- use of thermal mass for passive heating and cooling
- improving the thermal performance and

insulative properties of glazing, openings and the **building** fabric, particularly on west facing elevations

- avoiding the use of electric storage systems as the primary domestic hot water system for individual dwellings.

DG4.15.3 Consider initiatives that future proof the **development** for our changing energy environment, such as:

- designing the roof, electrical distribution system and metering with capacity for future installation of systems such as a photovoltaic array or battery storage that can provide the equivalent of at least 1kW energy per **dwelling**
- providing conduits and capacity in the electrical distribution system and metering for future provision of electric car charging within car parking areas.

Water management and conservation

► Intent

Rainfall conditions vary widely across the State, with different issues and priorities in different regions and catchments. In the southern half of Western Australia rainfall has been steadily declining while demand for water has been growing. The highest residential water consumption is in summer, due mainly to irrigation of gardens and lawns. Southern parts of the State are now subject to restrictions on garden irrigation. The water infrastructure response has been to turn to desalination, which now provides around half of the Perth scheme water supply.

The planning and design of **multiple dwelling development** should consider the contribution of the development to the water cycle and incorporate effective water management techniques that support quality of life and the provision of green space while moving towards a sustainable rate of water consumption.

Stormwater management is another important aspect of water sensitive design and plays a vital role in protecting **buildings** from flooding and managing the water cycle, improving water quality, protecting

ecosystems and improving urban **amenity**. The Department of Water and Environmental Regulation has defined a framework for the management of **small, minor and major rainfall events** in urban areas (refer definitions). Ecological protection is the desired outcome for management of a small event, which means that development should have sufficient stormwater infiltration and deep soil to manage a small rainfall event **on-site**. Serviceability and amenity are the desired outcomes for managing minor rainfall events, which means that infrastructure and amenity of the development should not be impacted by standing water. Flood protection is the main outcome for managing major rainfall events, which means that the development must have an overland flow path to reduce the likelihood of stormwater inundation of **enclosed** areas within the development.

Related Elements

- 3.3 *Tree canopy and deep soil areas*
- 4.12 *Landscape design*



Photo 4.16a The landscaped public domain for this development demonstrates the principles of Water Sensitive Urban Design.

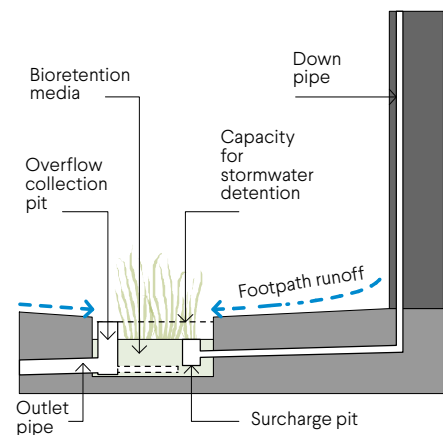

Figure 4.16a Illustration of a bioretention garden using plants to treat roof and surface water runoff.

ELEMENT OBJECTIVES

Development is to achieve the following Element Objectives:

O4.16.1 Minimise **potable water** consumption throughout the development.

O4.16.2 **Stormwater** runoff from **small rainfall events** is managed on-site, wherever practical.

O4.16.3 Reduce the risk of flooding so that the likely impacts of **major rainfall events** will be minimal.

ACCEPTABLE OUTCOMES

Acceptable Outcomes are likely to assist in satisfying the objectives but are not a comprehensive 'deemed-to-comply' list. In order to achieve the Element Objectives, proposals may require additional and/or alternative design solutions in response to the site conditions, streetscape and design approach.

A4.16.1 **Dwellings** are individually metered for water usage.

A4.16.2 **Stormwater** runoff generated from **small rainfall events** is managed on-site.

A4.16.3 Provision of an overland flow path for safe conveyance of runoff from **major rainfall events** to the local **stormwater** drainage system.

DESIGN GUIDANCE

Potential alternative solutions to satisfy the Element Objectives will be considered on a performance basis.

DG4.16.1 Good water management and conservation requires a holistic approach encompassing:

- principles of Water Sensitive Urban Design
- design management, such as the efficiency of appliances and fittings, and support for positive water use behaviours
- seeking alternative water sources and storage opportunities
- understanding water in the **landscape** and the impact of **multiple dwelling development** on the water cycle.

DG4.16.2 Individual **apartment** metering of water is an effective way to transfer price signals to apartment occupants to assist with reducing **potable water** use. Larger **developments** should consider the use of technology to enable remote reading.

DG4.16.3 When fittings and appliances are to be supplied by the developer, these should be within one level of the highest level available under the Water Efficiency Labelling and Standards (WELS) system.

DG4.16.4 The use of **potable water** on-site should be reduced. Strategies can include:

- using suitable and reliable alternative water sources, including waste water recycling or **rainwater** harvesting
- integrating infrastructure to harvest and store **stormwater** from the roof and/or sealed surfaces within the **building** and **landscape** design
- install **greywater** systems, or plan the wastewater drains to be 'greywater' ready for future conversion
- use irrigation systems that respond to soil moisture to maximise water efficiency
- select drought tolerant and low water use plants species.

DG4.16.5 **Stormwater** should be managed on-site as much as practical, consider:

- harvesting roof run-off for internal use for toilet flushing and clothes washing
- maximising the use of **permeable surfaces** at ground level to enable groundwater recharge, and minimising **impervious areas**
- incorporating on-site infiltration and detention systems such as garden beds, rain gardens, tree pits, infiltration cells and detention tanks (the latter shall be sited to avoid conflict with **deep soil areas**)
- designing **landscape** treatments to slow down overland flows and minimise opportunities for scouring
- minimising the potential for nutrient run off through appropriate plant species and soil selection in landscaped areas.

DG4.16.6 Planning and design shall consider the potential for flooding from **major rainfall events** and incorporate design responses to mitigate the impacts on occupants, **buildings** and the environment. Responses may include:

- considering the future risk of inundation on the basis of the best available estimates of future climate change impacts particular to the location
- provide sufficient area for **stormwater** detention/retention on-site
- ensure an overland flow path such that **habitable spaces** are not inundated in a major rain event
- integrate **stormwater** management systems in design of **landscaping, open space** and circulation areas.

Waste management

► Intent

Waste management is an important function of an **apartment building** requiring early consideration. Waste management processes and facilities should be integrated into the **development**, offering convenience, efficiency and safety for residents and waste management contractors, while minimising impacts on the visual and physical **amenity** of the development.

The State Government has established a target of diverting 65 per cent of solid waste from landfill by 2020. Waste management systems in **multiple dwelling** development can be designed to foster and enable waste management behaviours consistent with this strategy.

Applicants should liaise with the local government and/or waste removal contractor at an early stage to ensure the waste management system meets local collection requirements.

Related Elements

- 3.6 Public domain interface
- 3.8 Vehicle access
- 4.7 Managing the impact of noise



Photo 4.17a Dedicated recycling and waste disposal chutes allow source separation and recycling.



Photo 4.17b Communal waste facilities associated with circulation cores at each floor make waste handling convenient for residents.

ELEMENT OBJECTIVES

Development is to achieve the following Element Objectives:

- O4.17.1** Waste storage facilities minimise negative impacts on the **streetscape, building** entries and the **amenity** of residents.
- O4.17.2** Waste to landfill is minimised by providing safe and convenient bins and information for the separation and recycling of waste.

ACCEPTABLE OUTCOMES

Acceptable Outcomes are likely to assist in satisfying the objectives but are not a comprehensive 'deemed-to-comply' list. In order to achieve the Element Objectives, proposals may require additional and/or alternative design solutions in response to the site conditions, streetscape and design approach.

- A4.17.1** Waste storage facilities are provided in accordance with the Better Practice considerations of the *WALGA Multiple Dwelling Waste Management Plan Guidelines* (or local government requirements where applicable).
- A4.17.2** A Level 1 Waste Management Plan (Design Phase) is provided in accordance with the *WALGA Multiple Dwelling Waste Management Plan Guidelines - Appendix 4A* (or equivalent local government requirements).
- A4.17.3** Sufficient area is provided to accommodate the required number of bins for the separate storage of green waste, recycling and general waste in accordance with the *WALGA Multiple Dwelling Waste Management Plan Guidelines - Level 1 Waste Management Plan (Design Phase)* (or local government requirements where applicable).
- A4.17.4** Communal waste storage is sited and designed to be screened from view from the **street, open space** and private **dwelling**s.

DESIGN GUIDANCE

Potential alternative solutions to satisfy the Element Objectives will be considered on a performance basis.

- DG 4.17.1** Explore opportunities to influence diversion from landfill across the waste cycle from generation, disposal, storage and collection.
- DG 4.17.2** Consider the appropriate waste management systems for the scale and nature of **development**; for instance, combined bulk receptacles for larger developments with on-**site** bin management. Consult early with the local government or waste contractor to determine the right waste collection strategy for your development.
- DG 4.17.3** Avoid excessive numbers of individual **dwelling** wheeled bins where possible. Make sure that if kerbside pick-up is required, individual bins can be accommodated on the kerbside without impacting pedestrian use of the footpath or creating unsightly visual impacts.
- DG 4.17.4** Design on-**site** vehicle access and circulation areas to suit the required handling of bins, including the design of pedestrian access and circulation to allow bins to be easily manoeuvred between storage and collection points.
- DG 4.17.5** Consider providing temporary **storage** for large bulk items such as mattresses, taking into account management of these areas and the control of vermin, odour and dust.
- DG 4.17.6** In larger/taller **buildings**, incorporating waste chutes increases the convenience of waste management for occupants. Communal recycling rooms/cupboards can also be located throughout the **development**, coupled with an appropriate management regime to ensure regular removal of recyclables and management of the facility.

Utilities

► Intent

The early planning, coordination and design of **utilities** ensures that the siting and appearance of these essential services do not compromise design outcomes. Good design integrates utilities in the design of built form, circulation areas, **open space** and **streetscape**. If early consideration is not given to utilities, late stage design amendments may be required resulting in time delays and potentially compromising the provision of important services, such as fibre to premises broadband connections.

Utility networks and infrastructure are rapidly evolving in response to changes in technology, distribution networks and demand management. Proponents should evaluate current and emerging practice to ensure that design of utilities and demand management systems can meet the future needs of residents.

Related Elements

- 3.7 Public domain interface
- 4.3 Size and layout of dwellings
- 4.4 Private open space and balconies
- 4.5 Circulation and common spaces
- 4.10 Façade design
- 4.11 Roof design



Photo 4.18a This apartment building has incorporated service facilities into the design by making it visible and prominent and a feature along the internal wall. (PC)



Photo 4.18b This apartment is fibre-to-premises ready.



Photo 4.18c Carefully located and well-ventilated covered recess to conceal air-conditioning condenser unit.

ELEMENT OBJECTIVES

Development is to achieve the following Element Objectives:

- O4.18.1** The **site** is serviced with power, water, gas (where available), wastewater, fire services and telecommunications/broadband services that are fit for purpose and meet current performance and access requirements of service providers.
- O4.18.2** All **utilities** are located such that they are accessible for maintenance and do not restrict safe movement of vehicles or pedestrians.
- O4.18.3** **Utilities**, such as distribution boxes, power and water meters are integrated into design of **buildings** and **landscape** so that they are not visually obtrusive from the **street** or **open space** within the **development**.
- O4.18.4** **Utilities** within individual **dwellings** are of a functional size and layout and located to minimise noise or air quality impacts on **habitable rooms** and **balconies**.

ACCEPTABLE OUTCOMES

Acceptable Outcomes are likely to assist in satisfying the objectives but are not a comprehensive 'deemed-to-comply' list. In order to achieve the Element Objectives, proposals may require additional and/or alternative design solutions in response to the site conditions, streetscape and design approach.

- A4.18.1** **Utilities** that must be located within the front **setback**, adjacent to the **building** entry or on visible parts of the roof are integrated into the design of the building, **landscape** and/or fencing such that they are accessible for servicing requirements but not visually obtrusive.
- A4.18.2** **Developments** are fibre-to-premises ready, including provision for installation of fibre throughout the **site** and to every **dwelling**.
- A4.18.3** Hot water units, air-conditioning condenser units and clotheslines are located such that they can be safely maintained, are not visually obtrusive from the **street** and do not impact on functionality of outdoor living areas or internal **storage**.
- A4.18.4** Laundries are designed and located to be convenient to use, secure, weather-protected and well-vented; and are of an overall size and dimension that is appropriate to the size of the **dwelling**.

DESIGN GUIDANCE

Potential alternative solutions to satisfy the Element Objectives will be considered on a performance basis.

- DG 4.18.1** Consider infrastructure solutions that can respond to future as well as present needs, including broadband internet, smart meters and distribution capacity for on-**site** power generation and storage.
- DG 4.18.2** Consider the location of a fibre network and provision of fibre connections in **dwellings** at the earliest possible stage in the planning and design process. This can prevent expensive re-design or retrofitting.
- DG 4.18.3** Determine the requirements of service providers in terms of metering, distribution, on-**site** reticulation and maintenance access to ensure these requirements are well-integrated into the design of the **building frontage**.
- DG 4.18.4** Laundries located in a cupboard should have a clear width of at least 1m, a clear circulation area of at least 900mm to enable comfortable and safe access to the washing machine and tub, and adequate storage in the laundry for cleaning products and other related items.
- DG 4.18.5** Design and locate the laundry to reduce the impact of noise from an operating machine or drier on the living areas and bedrooms.
- DG 4.18.6** Ensure the laundry is adequately ventilated to remove hot damp air that may cause the growth of mould.
- DG 4.18.7** Consider the provision of communal laundries, located adjacent to communal areas.
- DG 4.18.8** Clothes lines are far more energy efficient than clothes dryers, seek opportunities to incorporate weather protected clothes drying in the building design.
- DG 4.18.9** Consider the provision of a screened **utilities balcony** incorporating air conditioning condenser units, hot water units and clothes drying.



Appendices

Supporting operational guidance, figures, definitions and photo credits.



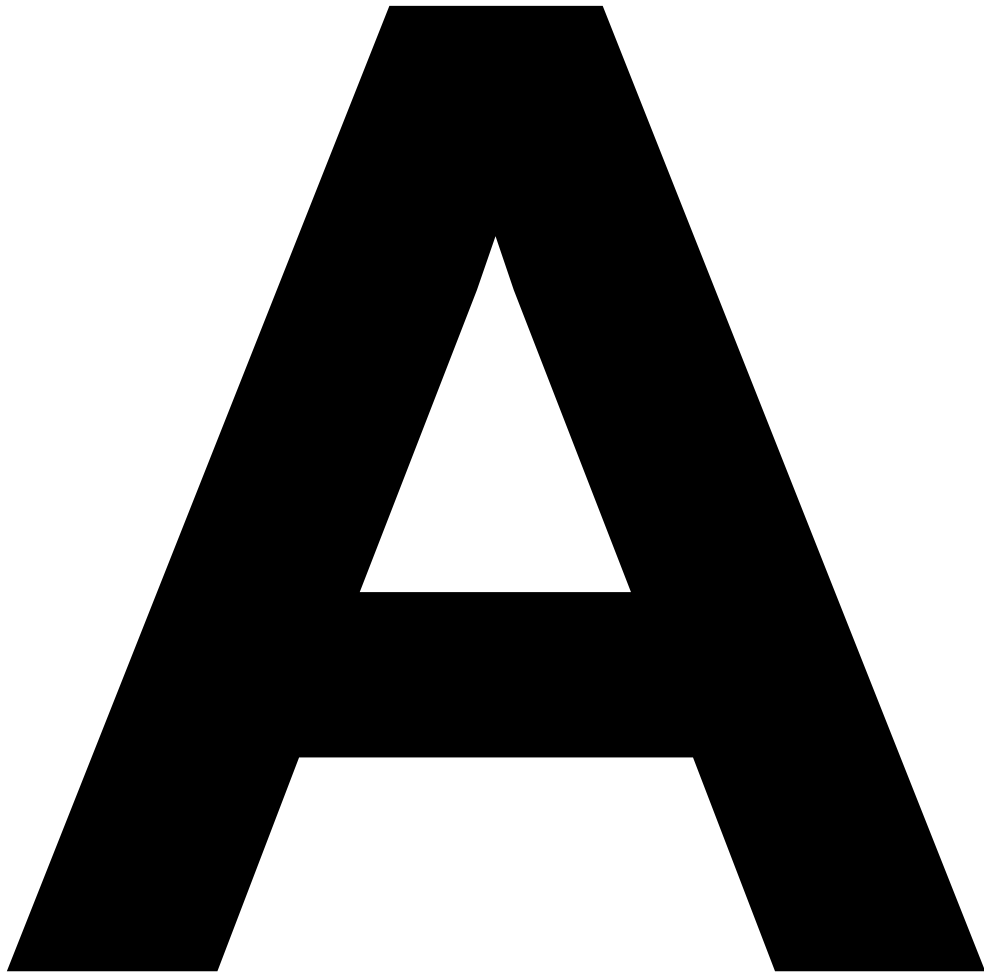

A1	TEN DESIGN PRINCIPLES TABLE	114
A2	STREETSCAPE CHARACTER TYPES	116
A3	SITE ANALYSIS AND DESIGN RESPONSE GUIDANCE	118
A4	DESIGN DEVELOPMENT GUIDANCE	121
A5	DEVELOPMENT APPLICATION GUIDANCE	122
A6	OBJECTIVES SUMMARY	124
A7	EXPLANATORY FIGURES	128
	DEFINITIONS	132
	PHOTO CREDITS	140

A1 – Ten design principles table

This table shows the relationship between the *Ten design principles* and elements of Parts 3 and 4 of R-Codes Vol.2. It indicates where key linkages generally apply (dark shading), though linkages may still apply beyond those indicated on this table (regular shading), based on the individual nature of each proposal.

PART 3 AND 4 ELEMENTS		TEN DESIGN PRINCIPLES									
		1 – Context and character	2 – Landscape quality	3 – Built form and scale	4 – Functionality and build quality	5 – Sustainability	6 – Amenity	7 – Legibility	8 – Safety	9 – Community	10 – Aesthetics
3.1	Site analysis and design response										
3.2	Orientation										
3.3	Tree canopy and deep soil areas										
3.4	Communal open space										
3.5	Visual privacy										
3.6	Public domain interface										
3.7	Pedestrian access and entries										
3.8	Vehicle access										
3.9	Car and bicycle parking										
4.1	Solar and daylight access										
4.2	Natural ventilation										
4.3	Size and layout of dwellings										
4.4	Private open space and balconies										
4.5	Circulation and common spaces										
4.6	Storage										
4.7	Managing the impact of noise										
4.8	Dwelling mix										
4.9	Universal design										
4.10	Façade design										
4.11	Roof design										
4.12	Landscape design										
4.13	Adaptive reuse										
4.14	Mixed use										
4.15	Energy efficiency										
4.16	Water management and conservation										
4.17	Waste management										
4.18	Utilities										

A2 - Streetscape character types

► SUBURBAN CONTEXTS

Low-rise

Context: Neighbourhoods that provide a mix of detached housing, group housing and **apartments**. They are predominately 1–2 **storeys** but may include 3-storey **development** on neighbourhood connector **streets**, adjacent to **open space** and/or on key **sites**. Apartment development should be located within walking distance of public transport, local shopping and local open space and may create a transition zone between a lower density residential area and higher density land uses.

Character: **Streetscapes** have a **landscaped character** and prevailing built form patterns of 1-2 storey detached **dwelling**s with defined front and side **setbacks**. New development should reflect the prevailing streetscape patterns and include significant on-site landscaping to enhance the streetscape and provide **amenity** for residents and neighbours.

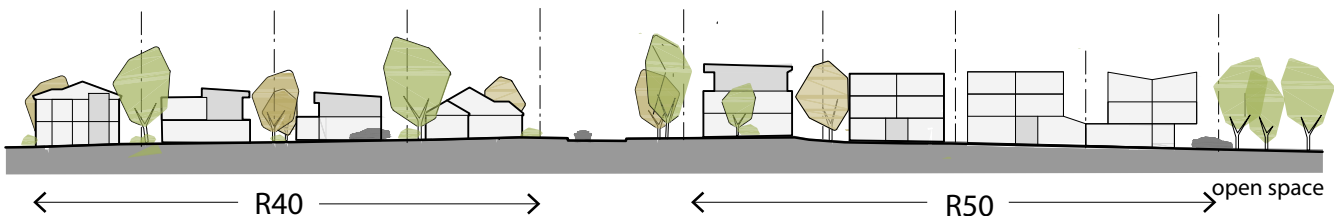

Note: Refer to R-Codes Volume 1 for R40 and R50 development.

Medium-rise

Context: Neighbourhoods with a **landscaped** residential setting that include a diversity of detached housing, group housing and **apartment developments** up to 3-4 **storeys**. The neighbourhood has good walkability to public transport, local services and quality **open space**, and may be located adjacent to higher density land uses or an urban corridor.

Character: **Streetscapes** have a **landscaped character** and built form patterns are defined by overall scale of the streetscape rather than individual **building** height or style. New development should reflect the prevailing patterns of side **setbacks** and respond to the existing or planned scale and materiality of the area. Development should include on-site landscaping to enhance streetscape and provide **amenity** for residents and neighbours.

Neighbourhood centre

Context: A local or neighbourhood centre within a low – medium rise residential area. Neighbourhood centres should be located within a short walk of transport and other amenities and include built form and uses that activate the **street**. Land uses within a neighbourhood centre may include residential, community facilities, local shopping and commercial activities.

Character: Neighbourhood centres have a compact and cohesive urban form that complements the surrounding residential character in scale and style. New **development** should contribute to the public realm by enhancing and activating the **streetscape** and contributing to creating a distinct and appealing character for the centre.

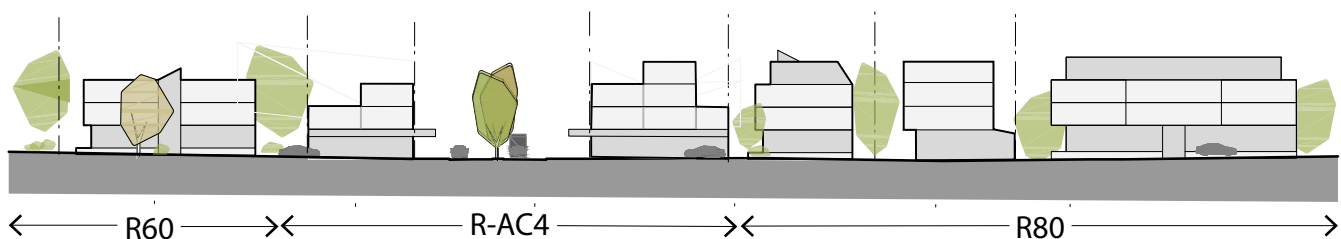

Note: Refer to R-Codes Volume 1 for R60 development.

► URBAN CONTEXTS

Higher density residential

Context: Higher density residential neighbourhoods are high **amenity**, predominately residential areas, located within a walking distance of a centre, **high-frequency** transport node and/or high amenity **open space**. The predominant built form is tall **apartment developments** in **landscaped streetscapes** with some mid-rise terrace style housing and walk-up apartments. The area may include **mixed use developments** that are compatible with the residential character of the area.

Character: Streetscapes retain an attractive **landscaped character** through **street** planting and landscaping of the private realm. Built form is typically 6 storeys or greater and **buildings** are separated to maintain residential amenity. Development should reflect the prevailing or planned pattern of side and street **setbacks** while taking advantage of the location, aspect and orientation of the **site**. Lower level **podiums** and **terraces** should achieve a pedestrian scale at the street **frontage**.

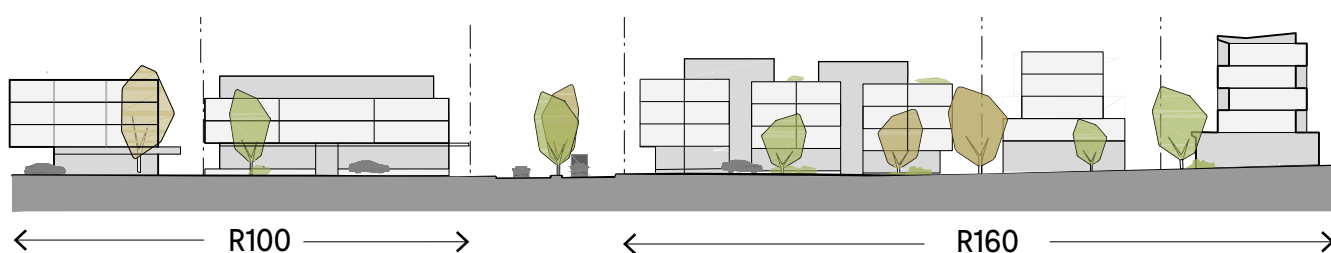

Mid-rise urban centres

Context: Urban centres may include town/district centres, urban corridors, **activity centres** and station precincts. Urban centres typically comprise **development** up to approximately 6-storeys that has direct **street frontage** and is often built to boundary. Urban centres are highly walkable with close proximity to **high-frequency** transit services, **public open space**, commercial and/or retail uses and community infrastructure.

Character: Urban centres are characterised by mid-rise **buildings** and contiguous, pedestrian friendly street frontages that include some activation. New development should create an attractive and coherent street frontage that complements adjoining buildings, has a pedestrian scale and provides **passive surveillance** of the street.

High density urban centres

Context: High density urban centres are largely commercial centres with some residential **development**. They have excellent multi-modal transit services and include **public open space** and a high concentration of community infrastructure. High density urban centres may include the CBD, city centres, strategic metropolitan centres, secondary centres, inner-city urban corridors, and designated specialised centres and station precincts.

Character: High density urban centres are characterised by **podium** and tower developments that support highly activated and pedestrianized **street frontages**. New residential development should contribute to an attractive, dynamic and liveable city environment.

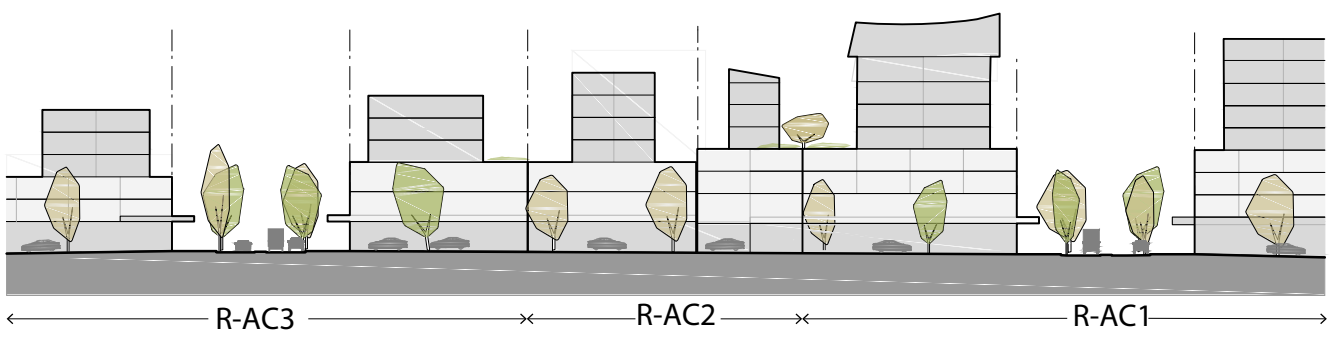

L Appendix 3 – Site analysis and design response guidance

A3 – Site analysis and design response guidance (1/2)

This guidance assists proponents to develop a site analysis and site design response when starting their design process in order to facilitate productive early design review discussions with the relevant local government.

SITE ANALYSIS

Category	Materials
<p>Site location/wider context plan</p>	<p>A plan/map diagram showing the wider context that identifies the site in relation to retail and commercial areas, community facilities, public open space, transport and other major public destinations within a 5-10 minute walk (400m radius) of the site. This plan shall also identify the climate zone of the site.</p>
<p>Local context plan</p>	<p>Plan(s) and photographs of the existing features of the wider context including adjoining properties and the other side of the street, that show:</p> <ul style="list-style-type: none"> – colour aerial photographs of the site in its context – pattern of buildings, proposed building envelopes and heights, setbacks and subdivision pattern – streetscape including land use, building typologies, overall height and important parapet/datum lines of adjacent buildings – movement and access for vehicles, servicing, pedestrians and cyclists – topography, landscape, open spaces and vegetation – significant views to and from the site – any sources of nuisance emissions in the vicinity of the site such as noise, light and odour that may have a bearing on the residential proposal, particularly vehicular traffic, train, aircraft and industrial noise – location of relevant heritage items, areas of environmental significance and elements of cultural significance – note the location of adjacent solar collectors.
<p>Site context and survey plan</p>	<p>Plan(s) of the existing site based on a survey drawing showing the features of the immediate site including:</p> <ul style="list-style-type: none"> – boundaries, site dimensions, site area, north point, street frontage, street name, lot number and address – topography, showing relative levels and contours at 0.5 metre intervals for the site and across site boundaries where level changes exist, any unique natural features such as rock outcrops, watercourses, existing cut or fill, adjacent streets and sites – location, type and size of existing trees exceeding 3m and/or significant landscaping features on site and relative levels where relevant, on adjacent properties and street trees – location, use, dimensions, setback distances of existing buildings or built features (such as retaining walls and other structures) on the site – identification and location of any areas of potentially valuable habitat vegetation – location and important characteristics of adjacent public, communal and private open spaces – location and height of existing windows, balconies, walls and fences on adjacent properties facing the site, as well as parapet and ridge lines – pedestrian and vehicular access points, driveways and features such as crossovers, truncations, service poles, transit stops, fire hydrants, access restriction (e.g. road islands adjacent to the site) etc. – location of utility services, including easements and drainage – the location of any adjoining and existing buildings that might affect, or be affected by, the proposed development, including the position of the proposed development, levels and position of habitable room windows, and designated outdoor living areas – location of any other relevant features.
<p>Streetscape elevations and sections</p>	<p>Photographs or drawings of the site in relation to the streetscape and along both sides of any street that the development fronts, that show:</p> <ul style="list-style-type: none"> – overall height (storeys, metres) and important parapet/datum lines of adjacent buildings – patterns of building frontage, street setbacks and side setbacks – planned heights.

A3 – Site analysis and design response guidance (2/2)

This guidance assists proponents to develop a site analysis and site design response when starting their design process in order to facilitate productive early design review discussions with the relevant local government.

DESIGN RESPONSE	
Category	Materials
Design response to context	<p>Drawings, 3D studies, and diagrams that synthesise and interpret the context into opportunities and constraints to generate early design parameters. Matters to cover:</p> <ul style="list-style-type: none"> – building massing, illustrating why the proposed massing and overall height are appropriate to the context – the public domain interface and street setback – relationship to and interface with adjacent properties, including side and rear setbacks – ventilation for the subject site and immediate neighbours.
Design response to building performance	<p>Drawings, 3D studies, and diagrams that synthesise and interpret the building performance into opportunities and constraints to generate early design parameters. Matters to cover:</p> <ul style="list-style-type: none"> – assessment of opportunities due to good site orientation, location and topography for on-site alternative power generation systems (photo voltaic/wind etc) – orientation and any overshadowing of the site and adjoining properties by neighbouring structures (excludes vegetation). The winter sun path should be shown between 9 am and 3 pm on 21 June – direction of prevailing wind and demonstration of the approach to maximise natural ventilation through the proposed building layout and massing – the geotechnical characteristics of the site and suitability of the proposed development – how culturally relevant or heritage elements have been considered in the design to provide a meaningful environment for residents – strategy for location of services such as pump and tanks for fire protection and electrical transformers and the like.
Design response to configuration	<p>Drawings, 3D studies, and diagrams that synthesise and interpret the building configuration into opportunities and constraints to generate early design parameters. Matters to cover:</p> <ul style="list-style-type: none"> – car parking approach proposed including footprint, depth, proposed vehicle access points and relationship to the provision of deep soil areas – how the layout of buildings on-site provides safe and high level of amenity for residents – proposed building footprint location – retained and proposed significant trees, vegetation, and deep soil areas – proposed communal open space – proposed car park footprint and depth – proposed building entries.

* Refer 3.1 Site analysis and design response and Figure A3 Site analysis diagrams (following pages).



Figure A3a Local context plan

Outlines the urban structure including streets and open spaces. It should also include topography contours, drainage and vegetation patterns, services and future infrastructure requirements (if known), land use zones, cadastre boundaries and identification of heritage items and other local landmarks. It is appropriate to address this scale when planning for individual or small groups of apartment building sites. A radius of 400 to 1000 metres should be considered.



Figure A3b Site context plan

Considers the character of the street(s) that the proposed development addresses, and shows its spatial enclosure by buildings or landscape elements. It should outline surrounding building uses and heights, front setbacks, pedestrian access, awnings, vehicle driveways and public domain elements including street trees, verges and footpaths. It is appropriate that all proposals for apartment buildings address this scale.

Site analysis legend

- Proposed development site
- Local shops
- Education facility
- Health campus
- Development site boundary
- Future buildings
- Existing buildings
- Existing building to changes
- Public open space
- Heritage listed building
- Railway line
- Train station
- Bus route
- Cycle lane



Figure A3c Site plan

Detailed consideration of the individual development site relative to neighbouring properties, buildings across the street and the public domain. It addresses surrounding and proposed deep soil areas and open spaces, existing vegetation and trees, fences, retaining walls, overshadowing impacts and privacy considerations. This scale should also highlight any other site specific factors such as orientation, slope, geology, infrastructure or access easements and stormwater management.

A4 – Design development guidance

This guidance assists proponents as their designs develop. It includes a list of basic information that should be provided by the applicant for design review prior to development application. The emphasis should be on having enough information to communicate the proposal effectively rather than having fully resolved drawings of every aspect of the project.

Category	Materials	Provided (Y/N)	
Site analysis and design response	[Prepared at earlier stage of design development in A3 <i>Site analysis and design response guidance</i>]		
Development details	A summary of the proposal that establishes the: <ul style="list-style-type: none"> – plot ratio – building height in metres and storeys – number and mix of apartments – number of car parking spaces – indicative percentage of apartments receiving the minimum level of cross ventilation and daylight access. 		
Precedents	Images of precedents relevant to the proposal such as: <ul style="list-style-type: none"> – streetscape concept – landscape design – communal open spaces use – building elements such as entries, balconies, materials. 		
Site plan	A drawing to scale showing: <ul style="list-style-type: none"> – any proposed site amalgamation or subdivision – the indicative footprint of the proposal – setbacks and building separation dimensions – site entry points – areas of communal open space and private open space – indicative locations of planting and deep soil areas including retained or proposed significant trees – interface with public domain – landscape intent (through simple sketches). 		
Floor plans	Drawings to scale showing: <ul style="list-style-type: none"> – the internal building layout and unit type distribution for the ground floor – representative middle floor, and the top floor – typical car park layout – sample unit plans with furniture layouts, key room depth dimensions – balcony sizes. 		
Building form and appearance	<p>Drawing to scale showing the basic massing of the proposal in the context of the adjacent three properties, or for 50m in each direction, on each elevation. This drawing should show, in diagrammatic form:</p> <ul style="list-style-type: none"> – the composition of the elevations including ground level, roof form, and articulation of massing of the overall building – pattern of buildings and spaces between buildings along the street – the profile of any existing buildings. <p>Preliminary indication of materials and colour palette should also be provided.</p>		
Sections	A drawing to scale showing: <ul style="list-style-type: none"> – the proposal and adjacent buildings – the relationship of the proposal to the ground plane, streets, open spaces and deep soil areas. 		
SPP7.0 Design Principles statement	A draft statement of key points that establishes how the proposal satisfies the Ten design principles of State Planning Policy 7.0 <i>Design of the Built Environment</i> .		

L Appendix 5 – Development application guidance

A5 – Development application guidance (1/2)

This guidance assists proponents in formulating the appropriate materials when submitting a development application. Check with the relevant local authority if there are any additional materials required.

Documentation	Required Information	Provided?	
Development details	<p>A summary document that provides the key details of the development proposal. It contains information such as the:</p> <ul style="list-style-type: none"> – plot ratio of the development – number, mix, size and accessibility of apartments – number of car parking spaces for use (residential, retail, accessible, visitor etc.) – percentage of apartments meeting cross ventilation and daylight requirements. 		
Site analysis	[Prepared at earlier stage of design development in <i>A3 Site analysis and design response guidance</i>]		
Design statements	<p>An explanation of how the design relates to the Ten design principles in State Planning Policy 7.0 <i>Design of the Built Environment</i>.</p> <p>An explanation of how the proposed development achieves the relevant objectives of this policy in <i>A6 Objectives summary</i>.</p> <p>For adaptive reuse projects which affect heritage places, provide a Heritage Impact Statement prepared in accordance with the State Heritage Office's <i>Heritage Impact Statement Guide</i> available at www.stateheritage.wa.gov.au (for state registered places) or the relevant local government guidelines (for other places).</p>		
Site plan	<p>A scale drawing showing:</p> <ul style="list-style-type: none"> – any proposed site amalgamation or subdivision – location of any proposed buildings or works in relation to setbacks, building envelope controls and building separation dimensions – proposed finished levels of land in relation to existing and proposed buildings and roads – pedestrian and vehicular site entries and access – interface of the ground floor plan with the public domain and open spaces within the site – areas of communal open space and private open space – indicative locations of planting and deep soil areas including retained or proposed significant trees. – overshadowing over neighbouring sites – location of adjacent solar collectors. 		
Landscape plan	<p>A scale drawing showing:</p> <ul style="list-style-type: none"> – the building footprint of the proposal including pedestrian, vehicle and service access – trees to be removed shown dotted – trees to remain with their tree protection areas (relative to the proposed development) – deep soil areas and associated tree planting – areas of planting on structure and soil depth – proposed planting including species and size – details of public space, communal open space and private open space – external ramps, stairs and retaining wall levels – security features and access points – built landscape elements (fences, pergolas, walls, planters and water features) – ground surface treatment with indicative materials and finishes – site lighting – stormwater management and irrigation concept design. 		
Other plans and reports	<p>Acoustic Report (or equivalent)</p> <p>Waste Management Plan (or equivalent)</p>		

A5 – Development application guidance (2/2)

Documentation	Required Information	Provided?	
Floor plans	<p>A scale drawing showing:</p> <ul style="list-style-type: none"> – all levels of the building including roof plan – layout of entries, circulation areas, lifts and stairs, communal spaces, and service rooms with key dimensions and Real Level (RL) heights shown – apartment plans with apartment numbers and areas, all fenestration, typical furniture layouts for each apartment type, room dimensions and intended use and private open space dimensions – accessibility clearance templates for accessible housing units and common spaces – visual privacy separation shown and dimensions where necessary – vehicle and service access, circulation and parking – storage areas. 		
Elevations	<p>A scale drawing showing:</p> <ul style="list-style-type: none"> – proposed building height and RL lines – building height control – setbacks or envelope outline – building length and articulation – the detail and features of the façade and roof design – any existing buildings on the site – building entries (pedestrian, vehicular and service) – profile of buildings on adjacent properties or for 50m in each direction, whichever is most appropriate. <p>Samples or images of proposed external materials, finishes and colours of the proposal, keyed to elevations.</p>		
Sections	<p>A scale drawing showing:</p> <ul style="list-style-type: none"> – proposed building height and RL lines – building height control – setbacks or envelope outline – adjacent buildings – building circulation – the relationship of the proposal to the ground plane, the street and open spaces particularly at thresholds – the location and treatment of car parking – the location of deep soil and soil depth allowance for planting on structure (where applicable) – building separation within the development and between neighbouring buildings – ceiling heights throughout the development – detailed sections of the proposed façades. 		
Building performance diagrams	<p>A solar diagram (where required) at the winter solstice (21 June) at a minimum of hourly intervals showing:</p> <ul style="list-style-type: none"> – number of hours of solar access to the principal communal open space – number of hours of solar access to units within the proposal and tabulation of results – overshadowing of existing adjacent properties and overshadowing of future potential development where neighbouring sites are planned for higher density – elevation shadows if likely to fall on neighbouring windows, openings or solar panels. <p>A ventilation diagram (where required) showing unobstructed path of air movements through dual aspect apartments and tabulation of results.</p>		
Illustrative views	<p>Photomontages or similar rendering or perspective drawings illustrating the proposal in the context of surrounding development. Note: Illustrative views need to be prepared using a perspective that relates to the human eye. Where a photomontage is prepared, it should use a photo taken by a full frame camera with a 50mm lens and 46 degree angle of view.</p>		
Models	<p>A three dimensional computer generated model showing views of the development from adjacent streets and buildings.</p> <p>A physical model for a large or contentious development (if required by the consent authority).</p>		

A6 – Objectives summary (1/4)

This summary assists proponents and assessors to explain and assess the development against the Element Objectives listed in this policy.

PART 2 – PRIMARY CONTROLS

2.2 Building height

- 2.2.1 The height of **development** responds to the desired future scale and character of the street and local area, including existing **buildings** that are unlikely to change.
- 2.2.2 The height of **buildings** within a **development** responds to changes in topography.
- 2.2.3 **Development** incorporates articulated roof design and/or roof top **communal open space** where appropriate.
- 2.2.4 The height of **development** recognises the need for **daylight** and **solar access** to adjoining and nearby residential development, **communal open space** and in some cases, public spaces.

2.3 Street setbacks

- 2.3.1 The **setback** of the **development** from the **street** reinforces and/or complements the existing or proposed **landscape character** of the street.
- 2.3.2 The **street setback** provides a clear transition between the public and private realm.
- 2.3.3 The **street setback** assists in achieving visual privacy to **apartments** from the street.
- 2.3.4 The **setback** of the **development** enables **passive surveillance** and outlook to the **street**.

2.4 Side and rear setbacks

- 2.4.1 **Building** boundary **setbacks** provide for adequate separation between neighbouring properties.
- 2.4.2 **Building** boundary **setbacks** are consistent with the existing **streetscape** pattern or the desired streetscape character.
- 2.4.3 The **setback** of **development** from side and rear boundaries enables retention of existing trees and provision of **deep soil areas** that reinforce the **landscape character** of the area, support tree canopy and assist with **stormwater** management.
- 2.4.4 The **setback** of **development** from side and rear boundaries provides a transition between **sites** with different land uses or intensity of development.

2.5 Plot ratio

- 2.5.1 The overall bulk and scale of **development** is appropriate for the existing or planned character of the area.

2.6 Building depth

- 2.6.1 **Building depth** supports **apartment** layouts that optimise **daylight** and **solar access** and **natural ventilation**.
- 2.6.2 Articulation of **building** form to allow adequate access to **daylight** and **natural ventilation** where greater **building depths** are proposed.
- 2.6.3 Room depths and / or ceiling heights optimise **daylight** and **solar access** and **natural ventilation**.

2.7 Building separation

- 2.7.1 New **development** supports the desired future **streetscape** character with spaces between **buildings**.
- 2.7.2 **Building** separation is in proportion to building height.
- 2.7.3 **Buildings** are separated sufficiently to provide for residential **amenity** including visual and **acoustic privacy**, **natural ventilation**, **sunlight** and **daylight** access and outlook.
- 2.7.4 Suitable areas are provided for **communal** and **private open space**, **deep soil areas** and **landscaping** between **buildings**.

A6 – Objectives summary (2/4)

PART 3 – SITING THE DEVELOPMENT

3.2 Orientation

- 3.2.1 Building layouts respond to the **streetscape**, topography and **site** attributes while optimising **solar** and **daylight access** within the **development**.
- 3.2.2 Building form and orientation minimises overshadowing of the **habitable rooms**, **open space** and **solar collectors** of neighbouring properties during **mid-winter**.

3.3 Tree canopy and deep soil areas

- 3.3.1 Site planning maximises retention of existing healthy and appropriate trees and protects the viability of **adjoining trees**.
- 3.3.2 Adequate measures are taken to improve tree canopy (long term) or to offset reduction of tree canopy from pre-**development** condition.
- 3.3.3 **Development** includes **deep soil areas**, or other infrastructure to support planting on structures, with sufficient area and volume to sustain healthy plant and tree growth.

3.4 Communal open space

- 3.4.1 Provision of quality **communal open space** that enhances resident **amenity** and provides opportunities for **landscaping**, tree retention and **deep soil areas**.
- 3.4.2 **Communal open space** is safe, **universally accessible** and provides a high level of **amenity** for residents.
- 3.4.3 **Communal open space** is designed and oriented to minimise impacts on the **habitable rooms** and **private open space** within the **site** and of neighbouring properties.

3.5 Visual privacy

- 3.5.1 The orientation and design of **buildings**, windows and **balconies** minimises direct overlooking of **habitable rooms** and private outdoor living areas within the **site** and of neighbouring properties, while maintaining **daylight** and **solar access**, ventilation and the external outlook of habitable rooms.

3.6 Public domain interface

- 3.6.1 The transition between the private and **public domain** enhances the privacy and safety of residents.
- 3.6.2 **Street** facing **development** and **landscape** design retains and enhances the **amenity** and safety of the adjoining **public domain**, including the provision of shade.

3.7 Pedestrian access and entries

- 3.7.1 Entries and pathways are **universally accessible**, easy to identify and safe for residents and visitors.
- 3.7.2 Entries to the **development** connect to and address the **public domain** with an attractive **street** presence.

3.8 Vehicle access

- 3.8.1 Vehicle access points are designed and located to provide safe access and egress for vehicles and to avoid conflict with pedestrians, cyclists and other vehicles.
- 3.8.2 Vehicle access points are designed and located to reduce visual impact on the **streetscape**.

3.9 Car and bicycle parking

- 3.9.1 Parking and facilities are provided for cyclists and other modes of transport.
- 3.9.2 Car parking provision is appropriate to the location, with reduced provision possible in areas that are highly walkable and/or have good public transport or cycle networks and/or are close to employment centres.
- 3.9.3 Car parking is designed to be safe and **accessible**.
- 3.9.4 The design and location of car parking minimises negative visual and environmental impacts on **amenity** and the **streetscape**.

A6 – Objectives summary (3/4)

PART 4 - DESIGNING THE BUILDING

4.1 Solar and daylight access

- 4.1.1 In climate zones 4, 5 and 6: the **development** is sited and designed to optimise the number of **dwelling**s receiving winter **sunlight** to **private open space** and via windows to **habitable rooms**.
- 4.1.2 Windows are designed and positioned to optimise **daylight** access for **habitable rooms**.
- 4.1.3 The **development** incorporates shading and glare control to minimise heat gain and glare:
 - from mid-spring to autumn in **climate zones** 4, 5 and 6 **AND**
 - year-round in climate zones 1 and 3.

4.2 Natural ventilation

- 4.2.1 **Development** maximises the number of **apartment**s with **natural ventilation**.
- 4.2.2 Individual **dwelling**s are designed to optimise **natural ventilation** of **habitable rooms**.
- 4.2.3 **Single aspect apartment**s are designed to maximise and benefit from **natural ventilation**.

4.3 Size and layout of dwellings

- 4.3.1 The internal size and layout of **dwelling**s is functional with the ability to flexibly accommodate furniture settings and personal goods, appropriate to the expected household size.
- 4.3.2 Ceiling heights and room dimensions provide for well-proportioned spaces that facilitate good **natural ventilation** and **daylight** access.

4.4 Private open space and balconies

- 4.4.1 **Dwelling**s have good access to appropriately sized **private open space** that enhances residential **amenity**.
- 4.4.2 **Private open space** is sited, oriented and designed to enhance liveability for residents.
- 4.4.3 **Private open space** and **balconies** are integrated into the overall architectural form and detail of the **building**.

4.5 Circulation and common spaces

- 4.5.1 Circulation spaces have adequate size and capacity to provide safe and convenient access for all residents and visitors.
- 4.5.2 Circulation and common spaces are attractive, have good **amenity** and support opportunities for social interaction between residents.

4.6 Storage

- 4.6.1 Well-designed, functional and conveniently located **storage** is provided for each **dwelling**.

4.7 Managing the impact of noise

- 4.7.1 The siting and layout of **development** minimises the impact of external noise sources and provides appropriate **acoustic privacy** to **dwelling**s and on-site **open space**.
- 4.7.2 Acoustic treatments are used to reduce sound transfer within and between **dwelling**s and to reduce noise transmission from external noise sources.

4.8 Dwelling mix

- 4.8.1 A range of **dwelling** types, sizes and configurations is provided that caters for diverse household types and changing community demographics.

4.9 Universal design

- 4.9.1 **Development** includes **dwelling**s with **universal design** features providing dwelling options for people living with disabilities or limited mobility and/or to facilitate ageing in place.

4.10 Façade design

- 4.10.1 **Building façades** incorporate proportions, materials and design elements that respect and reference the character of the local area.
- 4.10.2 **Building façades** express internal functions and provide visual interest when viewed from the public realm.

A6 – Objectives summary (4/4)

PART 4 - DESIGNING THE BUILDING (CONTINUED)

4.11 Roof design

O4.11.1 Roof forms are well integrated into the **building** design and respond positively to the **street**.

O4.11.2 Where possible, roof spaces are utilised to add **open space**, **amenity**, solar energy generation or other benefits to the **development**.

4.12 Landscape design

O4.12.1 **Landscape** design enhances **streetscape** and pedestrian **amenity**; improves the visual appeal and comfort of **open space areas**; and provides an attractive outlook for **habitable rooms**.

O4.12.2 Plant selection is appropriate to the orientation, exposure and **site** conditions and is suitable for the adjoining uses.

O4.12.3 **Landscape** design includes water efficient irrigation systems and, where appropriate, incorporates water harvesting or water re-use technologies.

O4.12.2 **Landscape** design is integrated with the design intent of the architecture including its built form, materiality, key functional areas and **sustainability** strategies.

4.13 Adaptive reuse

O4.13.1 New additions to existing **buildings** are contemporary and complementary and do not detract from the character and scale of the existing building.

O4.13.2 Residential **dwellings** within an adapted **building** provide good **amenity** for residents, generally in accordance with the requirements of this policy.

4.14 Mixed use

O4.14.1 **Mixed use development** enhances the **streetscape** and activates the **street**.

O4.14.2 A safe and secure living environment for residents is maintained through the design and management of the impacts of non-residential uses such as noise, light, odour, traffic and waste.

4.15 Energy efficiency

O4.15.1 Reduce energy consumption and greenhouse gas emissions from the **development**.

4.16 Water management and conservation

O4.16.1 Minimise **potable water** consumption throughout the **development**.

O4.16.2 **Stormwater** runoff from **small rainfall events** is managed on-**site**, wherever practical.

O4.16.3 Reduce the risk of flooding so that the likely impacts of **major rainfall events** will be minimal.

4.17 Waste management

O4.17.1 Waste storage facilities minimise negative impacts on the **streetscape**, **building** entries and the **amenity** of residents.

O4.17.2 Waste to landfill is minimised by providing safe and convenient bins and information for the separation and recycling of waste.

4.18 Utilities

O4.18.1 The **site** is serviced with power, water, gas (where available), wastewater, fire services and telecommunications/broadband services that are fit for purpose and meet current performance and access requirements of service providers.

O4.18.2 All **utilities** are located such that they are accessible for maintenance and do not restrict safe movement of vehicles or pedestrians.

O4.18.3 **Utilities**, such as distribution boxes, power and water meters are integrated into design of **buildings** and **landscape** so that they are not visually obtrusive from the **street** or **open space** within the **development**.

O4.18.4 **Utilities** within individual **dwellings** are of a functional size and layout and located to minimise noise or air quality impacts on **habitable rooms** and **balconies**.

A7 – Explanatory figures

Figure A7.1 has been deleted.

Element 3.2 Orientation

Figure A7.2 Proportionate limits from shared northern boundaries (refer A3.2.3).

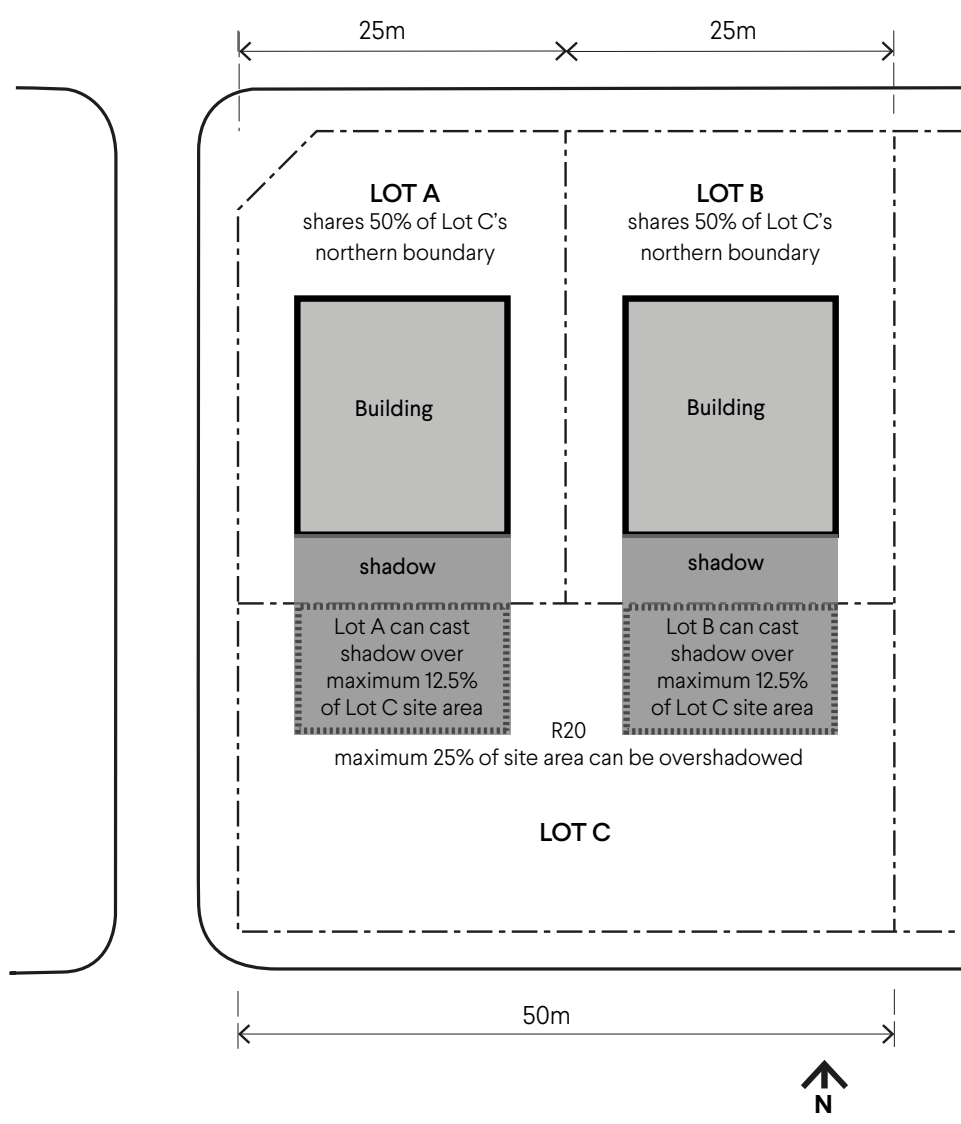

► Element 3.5 Visual privacy

Cone of vision diagrams

Figure A7.3a Establishing the horizontal component of cone of vision

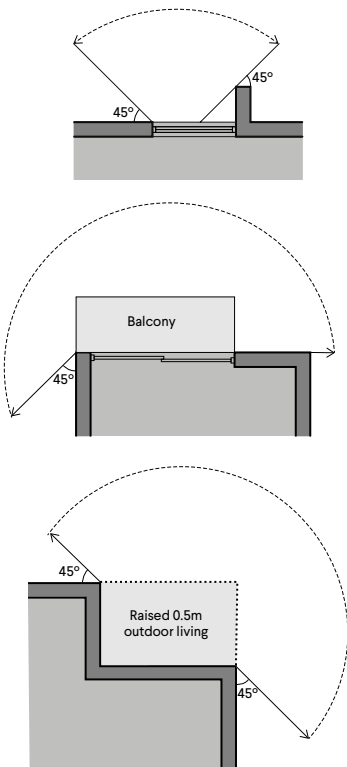

Figure A7.3b Measurement of minimum privacy separation distances

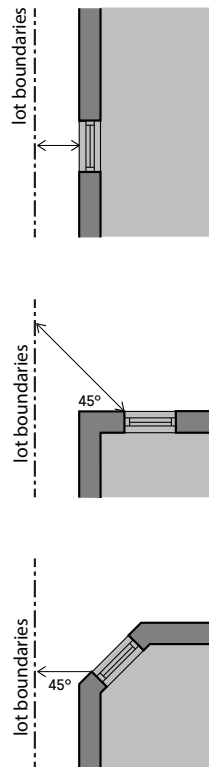
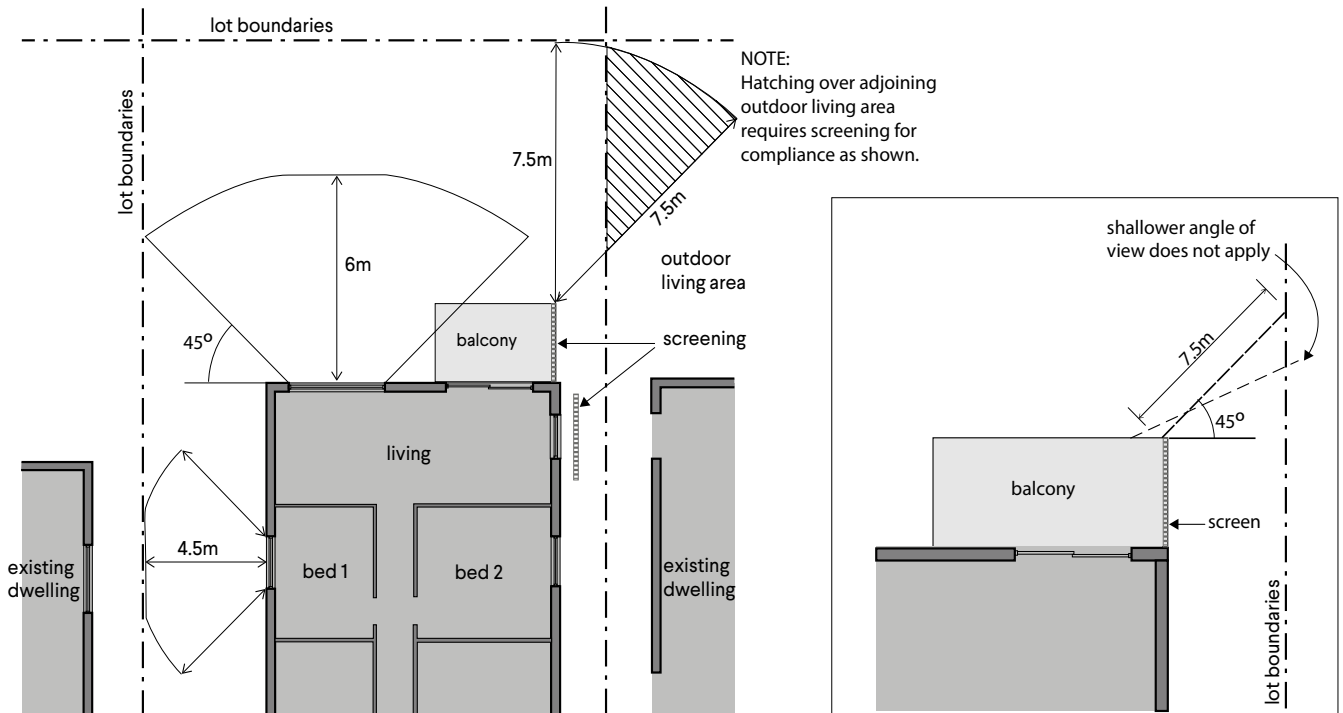

Figure A7.3c Measuring privacy setbacks using the cones of vision



Definitions

Definitions of terms used

In the case of an **apartment development** under Volume 2 of the R-Codes, unless the context requires otherwise, words and expressions have the meaning given to them below.

This list includes common terms and definitions shared with Volume 1 of the R-Codes insofar as they apply to apartment development. For all other definitions, refer to Volume 1 of the R-Codes.

Accessible housing / dwellings – dwellings having features already in place to enable use by people with disability.

Acoustic privacy – freedom from sound-based disturbance between **apartments**, between apartments and commercial areas, and between external and internal spaces.

Activity centre – as defined under the *Planning and Development (Local Planning Schemes) Regulations 2015*.

Adaptable housing / dwellings – dwellings designed and built to accommodate future changes to suit occupants with mobility impairment or life cycle needs.

Adaptive reuse – the conversion of an existing **building** or structure from one use to another, or from one configuration to another.

Adjoining tree/s – tree or trees located on a lot or reserve immediately adjacent to the **development site** and provide some canopy cover over it.

Amenity – as defined under the *Planning and Development (Local Planning Schemes) Regulations 2015* and includes the ‘liveability’, comfort or quality of a place which makes it pleasant and agreeable to be in for individuals and the community. Amenity is important in the public, communal and private domains and includes the enjoyment of **sunlight**, outlook, privacy and quiet. It also includes protection from pollution and odours.

Apartment – means a **multiple dwelling**.

At-grade – located at same height as ground level.

Balcony – a balustraded platform on the outside of a **dwelling** with access from an upper internal room.

Basement – a **building** floor level in which 50 per cent or more of its volume is below **natural ground level**.

Bay window – a window which projects a short way past the face of the **building**. It can have windows on the return walls and sometimes incorporates a seat.

BCA – Building Code of Australia, an element of the National Construction Code (**NCC**).

Building – any structure whether fixed or moveable, temporary or permanent, placed or erected on land, and the term includes **dwellings** and structures appurtenant to dwellings such as carports, garages, verandahs, patios, outbuildings and retaining walls, but excludes boundary fences, pergolas and swimming pools.

Building depth – the horizontal distance across the **building** including external walls, **balconies** and external circulation **walkways**.

Building envelope/s – as defined under the *Planning and Development (Local Planning Scheme) Regulations 2015* indicates the intended maximum extent of **development** for a **site**, defined by a combination of **building** height limits and **setbacks** from **street**, side and rear boundaries.

Building line – the predominant line formed by the main external face of the **building**. **Balconies** or **bay window** projections may or may not be included depending on desired **streetscape**.

Building massing – the overall shape, form and size of a **building**.

Circulation core – vertical circulation (lift and/or stairs) within a **building**. A single core may include multiple lifts serving the same **floor**.

Clerestory – high-level windows that can be part of a wall above a lower roof.

Climate zone – as defined by the **NCC**. Western Australia is divided into five climate zones based on humidity and temperature, ranging from temperate in the south-west to hot/ arid in the interior to hot/humid in the north. Refer *Climate Zones Map* at end of definitions.

Common property – has the meaning given by section 10 of the *Strata Titles Act 1985*.

Communal open space – outdoor areas within the **lot** and either at ground level or on structure that is accessible to and shared by occupants of the **dwellings** for communal recreational use. It does not include driveways or car parking areas.

Cone of vision – the limits of outlook from any given viewpoint for the purposes of assessing the extent of overlooking from that point, measured by applying a viewing cut off angle not less than 45 degrees horizontally and extending 90 degrees down to the ground.

Continuous path of travel – an uninterrupted route to or within premises or **buildings** and providing access to all services and facilities (AS1428.1). It should not incorporate any step, stairway, turnstile, revolving door, escalator, hazard or other impediment which would prevent it from being safely negotiated by people with disability.

Cornice – decorative horizontal moulding at the top of a **building** which 'crowns' or finishes the external **façade**.

Courtyard – open space at ground level or on a structure that is open to the sky and **enclosed** by the **building** on three or more sides.

CPTED – Crime Prevention Through Environmental Design.

Crossover – the vehicle access point (or **driveway**) running from the property boundary to the edge of the road.

Cross-over apartment – cross ventilating **apartment** with two opposite aspects and with a change in level between one side of the **building** and the other.

Cross-through apartment – cross ventilating **apartment** on one level with two opposite aspects.

Datum line – significant point or line in space established by the existing or desired context, often defined as an Australian Height Datum (AHD). For example, the top of significant trees or the **cornice** of a **heritage building**.

Daylight – consists of both skylight (diffuse light from the sky) and **sunlight** (direct beam radiation from the sun). Daylight changes with the time of day, season and weather conditions.

Deep soil area – soft landscape area on **lot** with no impeding **building** structure or feature above or below, which supports growth of small to large canopy trees and meets a stated minimum dimension. Used primarily for **landscaping** and open to the sky, deep soil areas exclude **basement** car parks, services, swimming pools, tennis courts and **impervious surfaces** including car parks, **driveways** and roof areas.

Development – as defined under the *Planning and Development Act 2005*.

Development site – as defined under the *Planning and Development (Local Planning Schemes) Regulations 2015*.

Driveway – the portion of the paved vehicle access way between a car parking area and the property boundary, excluding any associated **landscaping** or pedestrian path on either side.

Dual aspect apartment – cross ventilating **apartments** which have at least two major external walls with openings facing in different directions including corner and **cross-over apartments**.

Dual key apartment – an **apartment** with a common internal corridor and lockable doors to sections within the apartment so that it is able to be separated into two independent units. For the purposes of assessment they are considered as two units.

Dwelling – a **building** or portion of a building being used, adapted, or designed or intended to be used for the purpose of human habitation on a permanent basis by a single person, a single family, or no more than six persons who do not comprise a single family.

Enclosed – an area bound on three or more sides by a permanent wall and covered in an **impervious material**.

Façade – the external face of a **building**, generally the principal face, facing a public **street** or space.

Freehold scheme – has the meaning given by section 8(2) of the *Strata Titles Act 1985*.

Frontage – the width of a **lot** at the **primary street setback** line, provided that in the case of battleaxe or other irregularly shaped lots, it shall be as determined by the decision-maker.

Functional utilities – Functional utilities associated with the **dwelling** including, but not limited to air-conditioning, plant, clothes drying, hot water systems, antennas and satellite dishes, **solar collectors**, invertors and batteries, electric vehicle charging and rainwater tanks.

Green façade / green wall – a wall with fixtures to facilitate climbing plants. It can also be a cladding structure with growing medium to facilitate plant growth.

Green roof – a roof surface that supports the growth of vegetation comprising of a waterproofing membrane, drainage layer, organic growing medium (soil) and vegetation. Green roofs can be classified as either extensive or intensive, depending on the depth of substrate used and the level of maintenance required. Intensive green roofs are generally greater than 300mm deep and are designed as accessible **landscape** spaces with pathways and other features. Extensive green roofs are generally less than 300mm deep and are generally not trafficable.

Green title lot – A **lot** owned in fee simple issued with a certificate of title under the *Transfer of Land Act 1893*, other than a **strata lot** or a **survey-strata lot**.

Greywater – wastewater from clothes washing machines, showers, bathtubs, hand washing, lavatories and sinks that are not used for disposal of chemical or chemical-biological ingredients. Excludes water from the toilet (which is regarded as 'blackwater'). Refer to *Department of Health Guidelines for the Non-potable Uses of Recycled Water in Western Australia*.

Grouped dwelling – a **dwelling** that is one of a group of two or more dwellings on the same **lot** such that no dwelling is placed wholly or partly vertically above or below another, except where special conditions of **landscape** or topography dictate otherwise, and includes a dwelling in a **strata titles scheme** with common property.

Habitable room/space – as defined by the **NCC**; for a room/space used for normal domestic activities that includes a bedroom, living room, lounge room, music room, sitting room, television room, kitchen, scullery, dining room, sewing room, study, playroom, family room, sunroom, gymnasium, fully **enclosed** swimming pool or patio; but excludes a bathroom, laundry, water closet, pantry, walk-in wardrobe, corridor, hallway, lobby, photographic darkroom, clothes drying room, verandah and unenclosed swimming pool or patio and other spaces of a specialised nature occupied neither frequently nor for extended periods.

Heritage-protected place – as defined under the *Planning and Development (Local Planning Schemes) Regulations 2015*.

High-frequency route – a public transport route that runs a service at least every 15 minutes during weekday peak periods (7am to 9am and 5pm to 7pm).

Highlight window – window with a sill at 1600mm above floor level, or higher.

Impervious area/surface/material – surfaces that do not permit the penetration of **rainwater** into the ground and instead generate **stormwater** run-off, typically to drainage systems.

Internal floor area – in relation to a room or **dwelling**, the internal area measured within the finished surfaces of the **walls**, and includes the area occupied by any cupboard or other built-in furniture, fixture or fitting.

Juliet balcony – a small **balcony** with little or no projection, generally ornamental or only large enough for one person standing.

Landscape character – the distinct and recognisable pattern of elements that occurs consistently in a particular type of **landscape**, and how this is perceived by people. It reflects particular combinations of geology, landform, soils, vegetation, land use and human settlement.

Landscape / landscaping / landscaped – land developed with garden beds, shrubs and trees, or by the planting of lawns, and includes such features as rockeries, ornamental ponds, swimming pools, barbecue areas or playgrounds and any other such area approved of by the decision-maker as landscaped area.

Laneway – a narrow local **street** type without a verge located along the rear and/or side property boundary, typically used in more dense residential areas when smaller **lot** layouts justify rear garaging, and where alternative vehicle access is needed for lots fronting busy streets or parks.

Leasehold scheme – has the meaning given by section 8(3) of the *Strata Titles Act 1985*.

Legibility – where the design of the urban form, including the local **street** and **public open space** networks provides a sense of direction and connection, giving clear signals regarding the spatial layout and geography of an area.

Lightwell – an opening to the sky, **enclosed** on four sides by **building** volume, with a height to width ratio of more than 2:1.

Livable housing – dwellings designed for accessibility and long-term adaptability. *Livable Housing Design Guidelines* (Livable Housing Australia) standards are applicable in relation to this policy.

Local character / Local identity – the natural, cultural and historic characteristics of an area that are intrinsic to the locality, and which the local community relate to, or as defined in the **local planning framework**. See also **sense of place**.

Local development plan – as defined under the *Planning and Development (Local Planning Schemes) Regulations 2015*.

Local planning framework – comprises all strategic, statutory and policy planning documents which collectively outline the planning for an area and **development** requirements for **sites**, of the decision-maker and generally include a **scheme**, **local planning strategy** (including any housing component), **structure plans**, **local development plans** and **local planning policies**.

Local planning policy – any policy prepared by a local government in accordance with the procedures set out in the **local planning scheme**.

Local planning scheme – as defined under the *Planning and Development (Local Planning Schemes) Regulations 2015*.

Local planning strategy – as defined under the *Planning and Development (Local Planning Schemes) Regulations 2015*; a document which supports the preparation and review of a **local planning scheme** in accordance with Part 3 of the *Planning and Development (Local Planning Schemes) Regulations 2015*.

Loft – a room or space within the roof space of a **building**.

Lot – for single houses, a lot as defined under the *Planning and Development Act 2005*, as amended. For **multiple** or **grouped dwellings**, the **parent lot**.

Lot boundary – the boundary between a **lot** and any other parcel of land, excluding a **street boundary**.

Lot in a strata scheme – has the meaning given by section 3 of the *Strata Titles Act 1985*.

Lot in a survey-strata scheme – has the meaning given by section 3 of the *Strata Titles Act 1985*.

Major rainfall event – events greater than a **minor rainfall event** and up to and including the 1 per cent annual exceedance probability (AEP) event (refer Department of Water and Environmental Regulation).

Mansard roof – Where the upper level of the **building** is pitched and appears as an extension of the roof through the use of the same form and/or materials. Is counted as a **storey** where the vertical height is greater than 2.4 metres.

Mezzanine – an intermediate floor between main floors of a **building**.

Mid-winter – 21 June (winter solstice) when the sun is lowest in the sky.

Minor rainfall event – rainfall events greater than **small rainfall events** and less than **major rainfall events** (refer Department of Water and Environmental Regulation).

Mixed use development - buildings that contain commercial and other non-residential uses in conjunction with residential dwellings in a **multiple dwelling** configuration.

Multiple dwelling – a **dwelling** in a group of more than one dwelling on a **lot** where any part of the **plot ratio area** of a dwelling is vertically above any part of the plot ratio area of any other but:

- does not include a **grouped dwelling**; and
- includes any dwellings above the ground floor in a **mixed use development**.

Native vegetation - vegetation that has evolved or is endemic to a local area. These species are preferred as they are well-adapted to local soil and climate conditions, have lower water and fertiliser needs, and are often more resilient to pests and diseases.

Natural cross ventilation - natural ventilation which allows air to flow between positive pressure on the windward side of the **building** to the negative pressure on the leeward side of the building providing a greater degree of comfort and **amenity** for occupants. The connection between these windows must provide a clear, unobstructed air flow path. For an **apartment** to be considered cross ventilated, the majority of the primary living space and n-1 bedrooms (where n is the number of bedrooms) should be on a ventilation path.

Natural ground level - the levels on a **site** which precede the proposed **development**, excluding any site works unless approved by the decision-maker or established as part of subdivision of the land preceding development.

Natural ventilation - the movement of a sufficient volume of fresh air through a **dwelling** to refresh indoor air.

NCC - National Construction Code, comprising the Building Code of Australia (**BCA**) and Plumbing Code of Australia (PCA).

Non-habitable room/space – any room or space that is not defined as a **habitable room** or space in the **NCC**.

Open plan - dwelling layouts where spaces are not divided into discrete rooms, but are open and connected to allow flexibility of use (typically living, dining, kitchen and study areas).

Open space - generally that area of a **lot** not occupied by any **building** and includes:

- open areas of accessible and useable flat roofs and outdoor living areas above **natural ground level**
- areas beneath eaves
- verandahs, patios or other such roofed structures not more than 0.5m above natural ground level, unenclosed on at least two sides, and covering no more than 10 per cent of the **site area** or 50m² whichever is the lesser
- unroofed open structures such as pergolas
- uncovered **driveways** (including access aisles in car parking areas) and uncovered car parking spaces

but excludes:

- non-accessible roofs, verandahs, **balconies** and outdoor living areas over 1m above natural ground level
- covered car parking spaces and covered **walkways**, areas for rubbish disposal, stores, outbuildings or plant rooms.

Operable screens - louvres, sliding, folding or retractable elements on a **building** designed to provide shade, privacy, and protection from natural elements.

Operable walls - walls which can be moved, for example by sliding, folding, or pivoting, to allow for different room configurations or a **balcony**.

Parapet - the portion of a wall protruding above a roof or **terrace**. Often taken to refer to the decorative element which establishes the **street** wall height of **heritage buildings** (see **cornice**).

Parent lot - relating to **multiple** or **grouped dwellings**, the **lot** inclusive of common areas to which the **strata titles scheme** relates.

Passive surveillance - actual and perceived monitoring of public spaces by people as they go about their daily activities. Commonly referred to as 'eyes on the **street**'.

Permeable surface/ pavement - surfaces that permit the penetration of **rainwater**.

Plot ratio - the ratio of the gross **plot ratio area** of **buildings** on a **development site** to the area of land in the site boundaries.

Plot ratio area - the gross total area of all floors of **buildings** on a **development site**, including the area of any internal and external walls but not including:

- the areas of any lift shafts
- stairs or stair landings common to two or more **dwellings**
- machinery, air conditioning and equipment rooms
- space that is wholly below **natural ground level**
- areas used exclusively for the parking of wheeled vehicles at or below natural ground level;
- storerooms
- lobbies, bin storage areas, passageways to bin storage areas or amenities areas common to more than one dwelling; and
- **balconies**, eaves, verandahs, **courtyards** and roof **terraces**.

Podium - the base of a **building** upon which taller (tower) elements are positioned.

Potable water - water which conforms to Australian Standards for drinking quality.

Precinct structure plan - as defined under the *Planning and Development (Local Planning Schemes) Regulations 2015*.

Primary street - unless otherwise designated by the local government, the sole or principal public road that provides access to the major entry (front door) to the **dwelling** or **building**.

Private open space - means outdoor space located at ground level or on a structure that is within private ownership and provided for the recreational use of residents of the **dwelling** to which it abuts and excludes car parking spaces and access ways. It includes primary garden areas, outdoor living areas, **balconies**, **courtyards** and **terraces**.

Public domain - places accessible for common use by the public, including both the natural and built environment. It often includes **streets**, parks, and public **walkways**.

Public open space – publicly accessible land set aside for the purpose of public enjoyment and protection of unique, environmental, social and cultural values for existing and future generations. It is vested in or under the control of a public authority.

Rainwater – water harvested directly from roof runoff from domestic or commercial **buildings** and captured in rainwater tanks.

Root protection area – an area at the base of a tree to be retained and protected and in which contain critical roots required for the survival of that tree or group of trees.

Rootable soil zone / space – areas beyond the primary **deep soil area** under adjacent pavements that are engineered and constructed to support tree root penetration. This is achieved by the use of structural soil and structural cells which are materials for creation of rootable soil zone beneath pavements and other structures. Structural soil involves the use of structural materials, such as rock, that interlock under specified compaction loads while leaving macro spaces that provide rootable soil zone for tree roots. Structural cells are similar but utilise a plastic cell structure to meet the required compaction and loading.

Scheme Plan – has the meaning given by section 3 of the *Strata Titles Act 1985*, and for a **strata titles scheme** means the **strata plan** or **survey-strata plan** registered, or proposed to be registered, for the strata titles scheme as a scheme document.

Screening – permanently fixed external perforated panels or trellises composed of solid or obscured translucent panels.

Secondary street – in the case of a **site** that has access from more than one public road, a road that is not the **primary street**.

Sense of place – the essential memorable and recognisable characteristics of an area.

Service area – areas designated for **building** services installed to make the building functional, comfortable, efficient and safe.

Service utilities – supply and reticulation of essential services including, but not limited to power, water, gas, wastewater, fire services, letterboxes and telecommunications.

Setback – the horizontal distance between a wall at any point and an adjacent **lot boundary**, measured at right angles (90 degrees) to the boundary.

Sightlines – lines of clear physically uninterrupted sight.

Single aspect – a **dwelling** or room with openings facing primarily in one direction from a single major external wall.

Site –

- in the case of a single house, the **green title lot** or **survey strata lot** on which it stands.
- in the case of a **grouped dwelling**, the area occupied by the **dwelling** together with any area allocated (whether by way of **strata title scheme** or otherwise) for the exclusive use or benefit of that dwelling
- in the case of a **multiple dwelling** or **apartment development**, the **lot** (or **parent lot** where the lot is subdivided under a **strata scheme**) on which the dwellings stand.

Site area – the area of land required for the construction of a **dwelling** to satisfy the requirements of the R-Codes.

Site design response – illustrated design strategy based on a comprehensive analysis of a **site**. The site design response is carried out early in a design process to optimize the relationship between conflicting contextual design requirements.

Site-responsive – deriving from analysis of the physical characteristics of an area (such as landform, views, prevailing breezes, environmental features) and to manage constraints and opportunities to create optimum design outcomes.

Sloping site – a **site** with a slope of 15 per cent or greater.

Small rainfall event – the first 15mm of a rainfall event.

Soffit – the under surface of a **balcony** or other projecting **building** element.

Soft landscape – any **landscaped** area with a minimum soil depth of 300mm that contains in-ground planting, and excludes removable planter boxes/pots and **permeable paving** areas. Turf is included.

Solar access – is the ability of a building to continue to receive direct **sunlight** without obstruction from other **buildings** or impediments, not including trees.

Solar collectors – solar collecting components of the following: thermal heating systems, photovoltaic systems and skylights.

Stack effect ventilation or **solar chimney** – air convection resulting from hot air being pushed up and out by colder denser air which is drawn in at a lower level.

Standard structure plan – as defined under the *Planning and Development (Local Planning Schemes) Regulations 2015*.

Storage (inside apartments) – built-in furniture (fixed) such as linen cupboards, shelves, media cabinets, study nooks excluding storage located in kitchens, bathrooms and bedrooms.

Storage (external to apartments) – dedicated, secured and conveniently located areas for the storage of large or bulky items. This is to be in addition to any internal **apartment** storage in kitchens, bathrooms and bedrooms.

Storey – the portion of a **building** which is situated between the top of any floor and the top of the floor next above it and if there is no floor above it, that portion between the top of the floor and the ceiling above it but does not include:

- a **basement**
- a space that contains only a lift shaft, stairway or meter room
- a **mezzanine**
- a **loft**.

Double height floors greater than 5m floor to ceiling are counted as two floors.

Stormwater – urban surface water runoff from rainfall events, consisting of rainfall runoff and any material (soluble and insoluble) mobilised in its path of flow.

Strata lot – refer to definition for a **lot in a strata scheme**.

Strata plan – has the meaning given by section 3 of the *Strata Titles Act 1985*.

Strata scheme - has the meaning given by section 3 of the *Strata Titles Act 1985*, and may include **freehold** or **leasehold schemes**.

Strata Titles Scheme - has the meaning given by section 3 of the *Strata Titles Act 1985*.

Street - any public road, communal street, private street, **laneway**, right-of-way or other shared access way that provides the principal **frontage** to a **dwelling** but does not include an access leg to a single battleaxe **lot**.

Street boundary - the boundary between the land comprising a **street** and the lands that abuts thereon.

Streetscape - the visible components in a **street** between the facing **buildings**, including the form of the buildings, garages, **setbacks**, fencing, **driveways**, **utilities**, street surfaces, street trees and street furniture such as lighting, signs, barriers and bus shelters.

Structure plan - as defined under the *Planning and Development (Local Planning Schemes) Regulations 2015*.

Studio - a **dwelling** consisting of one **habitable room** that combines kitchen, living and sleeping space.

Sunlight - direct beam radiation from the sun.

Survey-strata lot - refer to definition for **lot in a survey-strata scheme**.

Survey-strata plan - has the meaning given by section 3 of the *Strata Titles Act 1985*.

Survey-strata scheme - has the meaning given by section 3 of the *Strata Titles Act 1985* and may include **freehold** or **leasehold schemes**.

Sustainability/Subsustainable - meeting the needs of current and future generations through the integration of environmental protection, social advancement and economic prosperity.

Ten design principles - means the Design Principles as set out by State Planning Policy 7.0 - *Design of the Built Environment*: Schedule 1.

Terrace - an outdoor area, usually paved and unroofed, that is connected to a **dwelling** and accessed from at least one room. May be **at-grade** or on a structure such as a **podium** or a roof.

Tree management plan - a plan that sets out the tree protection measures required prior to, during, and post construction.

Trickle vent - a very small permanent opening in a window or a wall that allows small amounts of ventilation into spaces intended to be **naturally ventilated** when major openings (windows, doors, etc) are otherwise closed.

Universally accessible / Universal access - features to enable use and access by people with disability.

Universal design - the design of products and environments that are inherently **accessible** to all, including older people and people with disability.

Utilities - external fixtures, equipment, plant or other structures which are necessary for a **dwelling** to achieve efficient, comfortable and environmentally sustainable operating outcomes and includes **service** and **functional utilities** or other fixtures as necessary for the residential use of the **buildings** on-site. It excludes essential plumbing vents above the roof line and external roof-water down pipes.

Visually permeable - in reference to a wall, gate, door, screen or fence that the vertical surface, when viewed directly from the **street** or other public space, has:

- continuous vertical or horizontal gaps of 50mm or greater width occupying not less than one third of the total surface area;
- continuous vertical or horizontal gaps less than 50mm in width, occupying at least one half of the total surface area in aggregate; or
- a surface offering equal or lesser obstruction to view.

Walkable catchment - the actual area served within a walking distance along the **street**/footpath network from a public transport stop/station entrance or an **activity centre**.

Walkway - an external circulation area, generally single loaded, which provides access to individual **apartments** along its length.

WAPC - Western Australian Planning Commission.

Wintergarden - an **enclosed balcony**, typically glazed and can be used to minimise noise impacts along busy roads, railway lines and from aircraft noise.

Winter solar gain - the heating of the **building** interior due to **sunlight** penetration through windows or heating of the building mass.

Definitions

Climate Zone Map

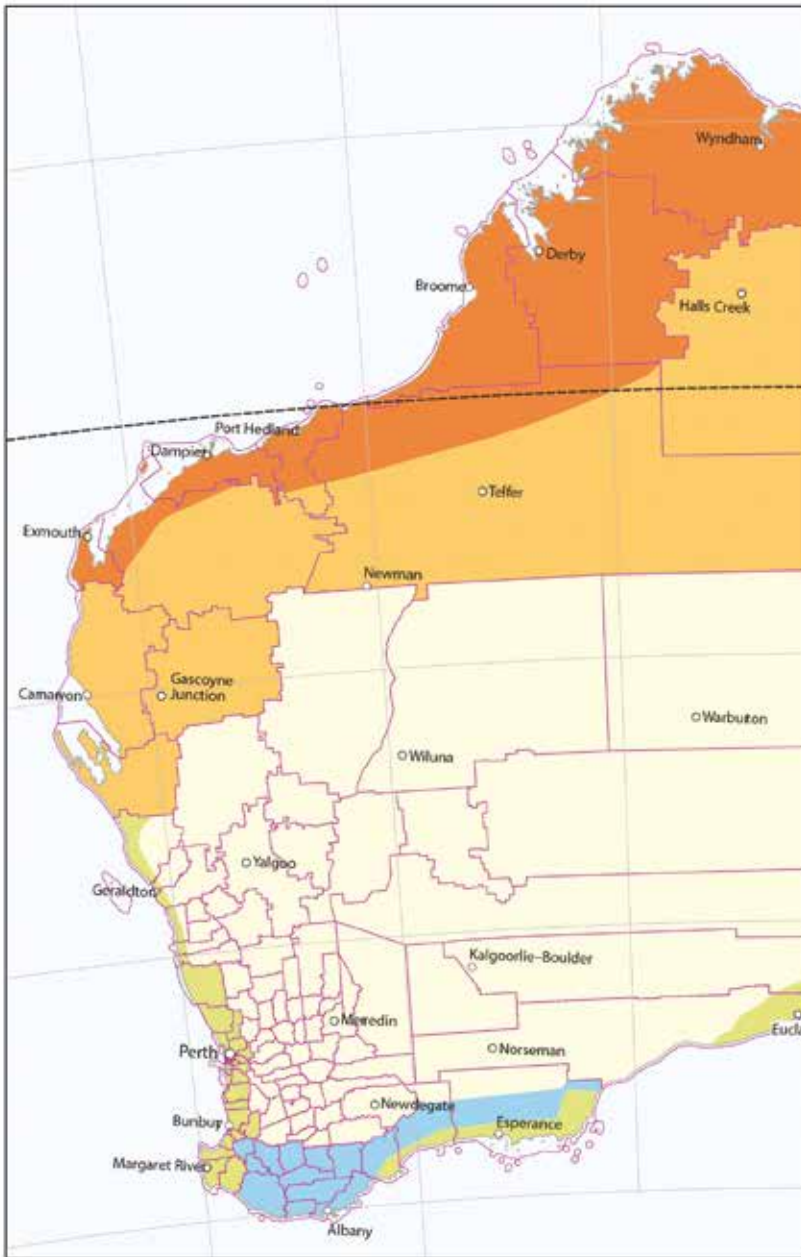

Climatic Zones - Western Australia

- | | |
|--|--|
|  Zone 1 - High humidity summer, warm winter |  Zone 5 - Warm temperate |
|  Zone 2 - Warm humid summer, mild winter (NA to WA) |  Zone 6 - Mild temperate |
|  Zone 3 - Hot dry summer, warm winter |  Zone 7 - Cool temperate (NA to WA) |
|  Zone 4 - Hot dry summer, cool winter |  Zone 8 - Alpine (NA to WA) |
|  Local Government Area Boundary | |

Extracted from Climatic Zone map of Australia published by ABCB (last amendment August 2015)

This page has intentionally been left blank

Photo credits

Acknowledgement

The Department of Planning, Lands and Heritage and the **WAPC** gratefully acknowledge the following contributors for allowing the use of these photographs to illustrate this document.

Photo ref.	Page	Photo credit	Designer / Developer	Name of Development / Location
Cover	Cover	Greg Hocking	Cameron Chisholm Nicol / Georgiou	The Pocket / Davies Rd, Claremont WA
1.3a	7	DPLH	–	–
1.3b	7	DPLH	–	–
3.3a	36	DPLH	Finbar	Arbor North / Rowe Ave, Rivervale WA
3.4a	42	DPLH	Cameron Chisholm Nicol / Georgiou	The Pocket / Davies Rd, Claremont, WA
3.4b	42	Dion Robeson	MJA Studio / Handle Property Group	The Bottleyard / Palmerston St, Perth WA
3.4c	42	DPLH	Finbar	St Marks / Stirling St, Highgate WA
3.4d	42	Dion Robeson	Hillam Architects / Blackburne	Haven / Wickham St, East Perth WA
3.4e	42	Dion Robeson	Hillam Architects / Edge	The Collective / Riversdale Rd, Rivervale WA
3.4f	42	DPLH	Hillam Architects / Blackburne	Aria / Milyarm Rise, Swanbourne WA
3.6a	46	DPLH	Cameron Chisholm Nicol / Iris Residential	Ocean Edge Beachside Apartments / Orsino Blvd, North Coogee WA
3.6b	46	DPLH	–	The Circus, Burswood WA
3.6c	46	DPLH	–	Bow River Crescent, Burswood WA
3.6d	48	DPLH	–	Henry Lawson Walk, East Perth WA
3.6e	48	DPLH	Design Management Group / Blackburne	Monarc / Harold St, Highgate WA
3.6f	48	DPLH	–	Lawrence St, West Perth WA
3.6g	48	Dion Robeson	MJA Studio / Handle Property Group	The Bottleyard / Palmerston St, Perth WA
3.6h	48	Handle Property Group	MJA Studio / Handle Property Group	The Bottleyard / Palmerston St, Perth WA
3.7a	50	DPLH	Cameron Chisholm Nicol / Iris Residential	Empire East / Dynevor Rise, Floreat WA
3.7b	50	Handle Property Group	MJA Studio / Handle Property Group	The Bottleyard / Palmerston St, Perth WA
3.7c	50	Dion Robeson	Hillam Architects	Verde / Wittenoom St, East Perth WA
3.8a	52	DPLH	Cameron Chisholm Nicol / Georgiou	The Pocket / Davies Rd, Claremont WA
3.9a	56	DPLH	Department of Communities	Fremantle Cold Stores / Beach St, Fremantle WA
3.9b	56	DPLH	Builton	Blythe Ave, Yokine WA
3.9c	56	DPLH	JCY Architects and Urban Designers / Psaros	Flo Apartments / The Springs, Rivervale WA
3.9d	56	DPLH	–	Beaufort St, Mount Lawley WA
3.9e	56	DPLH	Klopper & Davis Architects / Celsius Developments	The Fitz / Fitzgerald St, North Perth WA

Photo ref.	Page	Photo credit	Designer / Developer	Name of Development / Location
4.1a	62	Robert Frith – Acorn Photo	Spaceagency / FJM & LandCorp	Knutsford / Knutsford St, Fremantle WA
4.1b	62	DPLH	Cameron Chisholm Nicol / Georgiou	The Pocket / Davies Rd, Claremont WA
4.1c	62	Joel Barbitta	Kerry Hill Architects / Mirvac	Beachside / Leighton Beach Blvd, North Fremantle WA
4.1d	62	DPLH	–	Beaufort St, Perth WA
4.1e	62	Landcorp	Cameron Chisholm Nicol / Iris Residential	Empire East / Dynevor Rise, Floreat WA
4.1f	62	LandCorp	–	Destiny Apartments / Perry Lakes, Floreat WA
4.2a	66	Tom Ferguson	Turner	Union Balmain / Balmain Peninsula, Rozelle, NSW
4.2b	66	DPLH	Baltinas	Halo on Mount / Mount St, West Perth WA
4.2c	66	DPLH	David Barr Architects / Landcorp	Gen Y Demonstration Housing / Hope St, White Gum Valley WA
4.2d	66	Dion Robeson	MJA Studio / Parcel	Fringe / William St, Mount Lawley WA
4.3a	70	DPLH	Cameron Chisholm Nicol / Georgiou	The Pocket / Davies Rd, Claremont, WA
4.3b	70	Dion Robeson	Hillam Architects / Blackburne	Encore / Roydhouse St, Subiaco WA
4.4a	72	Dion Robeson	Klopper & Davis Architects	Labouchere Rd, Como WA
4.4b	72	Damien Hatton	JCY Architects and Urban Designers	Fitzgerald St Housing / Fitzgerald St, North Perth WA
4.4c	74	DPLH	Spaceagency / FJM & LandCorp	Knutsford / Knutsford St, Fremantle WA
4.4d	74	DPLH	Hillam Architects / Blackburne	Aria / Milyarm Rise, Swanbourne WA
4.5a	76	Dion Robeson	Hillam Architects	Verde / Wittenoom St, East Perth WA
4.5b	76	Brett Boardman	Turner	Diversity B Apartments / Waterloo NSW
4.5c	76	Klopper & Davis Architects	Klopper & Davis Architects	696 Albany Hwy Apartments / Albany Hwy, Victoria Park WA
4.5d	78	DPLH	Cameron Chisholm Nicol / Georgiou	The Pocket / Davies Rd, Claremont WA
4.5e	78	Damien Hatton	JCY Architects and Urban Designers	Fitzgerald St Housing / Fitzgerald St, North Perth WA
4.5f	78	Greg Hocking	Cameron Chisholm Nicol / Match	Heirloom / Queen Victoria St, Fremantle WA
4.6a	80	DPLH	Cameron Chisholm Nicol / Georgiou	The Pocket / Davies Rd, Claremont WA
4.6b	80	DPLH	Cameron Chisholm Nicol / Iris Residential	Empire East / Dynevor Rise, Floreat WA
4.7a	84	DPLH	Breathe Architects	The Commons / Florence St, Melbourne VIC
4.7b	84	DPLH	Baltinas	Halo on Mount / Mount St, West Perth WA
4.7c	84	DPLH	Baltinas	Halo on Mount / Mount St, West Perth WA
4.9a	88	DPLH	Hillam Architects / Blackburne	Aria / Milyarm Rise, Swanbourne WA
4.10a	90	DPLH	Cameron Chisholm Nicol / Iris Residential	Ocean Edge Beachside Apartments / Orsino Blvd, North Coogee WA
4.10b	90	DPLH	MJA Studio / Blackburne	Luxton / Bulwer St, Perth WA
4.10c	90	DPLH	MJA Studio / Handle Property Group	The Bottleyard / Palmerston St, Perth WA
4.10d	90	Dion Robeson	Hillam Architects / Blackburne	Aria / Milyarm Rise, Swanbourne WA
4.11a	92	DPLH	Rothelowman	Eden Haven Sanctuary / Victoria St, Abbotsford VIC

Appendices

Photo credits

Photo ref.	Page	Photo credit	Designer / Developer	Name of Development / Location
4.11b	92	DPLH	Breathe Architects	The Commons / Florence St, Melbourne VIC
4.11c	92	DPLH	Psaros	Depot / Brewer St, Perth WA
4.12a	94	David McLoughlin	HHA Architects / Department of Communities	Living Space / Signal Tce, Cockburn Central WA
4.12b	94	DPLH	Design Management Group / Blackburne	Monarc / Harold St, Highgate WA
4.12c	96	Rob Ramsay	JCY Architects and Urban Designers / Foundation Housing	Bennett Street / Bennett St, East Perth WA
4.12d	96	DPLH	Cameron Chisholm Nicol / Frasers Property	Kingston the Fourth / Midgegooroo Ave, Cockburn Central WA
4.12e	96	DPLH	Department of Communities	Fremantle Cold Stores / Beach St, Fremantle WA
4.12f	96	DPLH	Gary Dempsey Developments	Taskers / McCabe St, North Fremantle WA
4.12g	96	DPLH	Cameron Chisholm Nicol / Georgiou	The Pocket / Davies Rd, Claremont, WA
4.12h	96	DPLH	–	College Corner, O'Conner WA
4.13a	98	DPLH	Match	HOME (WD & HO Wills Building) / Murray & Milligan St, Perth WA
4.13b	98	DPLH	Department of Communities	Fremantle Cold Stores / Beach St, Fremantle WA
4.13c		Greg Hocking	Cameron Chisholm Nicol / Match	Heirloom / Queen Victoria St, Fremantle WA
4.14a	100	DPLH	–	Claisebrook Cove, East Perth WA
4.14b	102	DPLH	Cameron Chisholm Nicol / Frasers Property	Kingston the Fourth / Midgegooroo Ave, Cockburn Central WA
4.14c	102	DPLH	–	Fiveways / South Tce, South Fremantle WA
4.14d	102	Tom Ferguson	Turner	East Village / Zetland NSW
4.14e	102	DPLH		Rouse Hill, Sydney NSW
4.14f	102	DPLH	Hassell / Zone Q	Pinnacle South Perth / Charles St, South Perth WA
4.15a	104	Handle Property Group	MJA Studio / Handle Property Group	The Bottleyard / Palmerston Road, Perth WA
4.16a	106	DPLH	Landcorp	Perry Lakes, Floreat WA
4.17a	108	DPLH	Cameron Chisholm Nicol / Georgiou	The Pocket / Davies Rd, Claremont WA
4.17b	108	DPLH	Cameron Chisholm Nicol / Georgiou	The Pocket / Davies Rd, Claremont WA
4.18a	110	Michael Downes (UA Creative)	Breathe Architects	The Commons / Florence St, Melbourne VIC
4.18b	110	DPLH	Cameron Chisholm Nicol / Georgiou	The Pocket / Davies Rd, Claremont, WA
4.18c	110	DPLH	Cameron Chisholm Nicol / Georgiou	The Pocket / Davies Rd, Claremont, WA